

SHORT-WAVE STATION LIST

RADIO NEWS

SEPTEMBER
25 Cents

and
Radio Call Book Magazine
an
Technical Review

New!
A "Metal" Tube



A Publication Devoted to Progress and Development in Radio

Experimental Research
DX Reception
Short Waves
Amateur Activity

Service Work
Engineering
Industrial Application
Electronics

Electrical Measurement
Broadcasting
Set Building
Television



Let's look into this!

WHY are over 10,000 copies of the "Radio Experimenters' Hand Book" now in use? What is the reason for the multitude of enthusiastic letters received by its editors? Read the partial list of contents given below and note the mass of important radio data in this valuable book. You'll want a copy yourself!

Partial List of Contents

THERE are chapters on: *Laboratory and Shop Notes*—wiring hints, inductance mountings, doctoring dynamic speakers; *Antenna Notes and Experiments*—static reduction systems, auto-radio antenna, tuning units; *Miscellaneous Radio Experiments*—experimental recording, secret communication, DX reception tips; *Experimental Circuits in Radio and Electronics*—crystal, superheterodyne, screen-grid, and all-wave receivers.

136 Pages of Data

ALSO, *Principles of Short-Wave Reception*—antenna systems, transmitter remote control, extending receiver range; *Ultra-Short-Wave Essentials*—receivers, the super-regenerator, the Barkhausen-Kurz oscillator; *Equipment for Photo-Electric Work*—photo-cell amplifiers, making a photo-cell, time-delay relays; *Experimental Television Data*—the optical system, hints for tuning, operating data.

150 Illustrations

AND, *Electrical Measurements*—multipliers, thermo-couples, the vacuum-tube voltmeter; *Resistance, Inductance, Capacity Measurements*—the parallel circuit, calibration of meters, the Wheatstone bridge; *Miscellaneous Measurements*—resonance indicators, zero-beat methods, wavelength calibration; *Design of Radio Components*—easy calculation charts, design of condensers, coils and power-transformers; *Circuit Design Data*—microphone, receiver and oscillator design.

Here's How To Get It Free!

THIS priceless radio guide—cramped full of useful data—will be sent free with a 5 month subscription for *Radio News* at the money-saving price of \$1. Use the coupon today—the "Radio Experimenters' Hand Book" is a valuable addition to any radio man's library!

Radio News, Dept. 9
222 W. 39th St., New York, N. Y.

Send me a free copy of the "Radio Experimenters' Hand Book." I enclose \$1 for the next 5 issues of RADIO NEWS. If renewal, check .

Name.....

Address.....

City..... State.....

(Canada & Foreign \$1.50)

RADIO NEWS

Will Show You Too

How to Start a Spare Time or Full Time

Radio Service Business of Your Own

Without Capital



J. E. SMITH, President
National Radio Institute

The man who has directed the Home-Study Training of more men for the Radio industry than any other man in America.

Here are a few examples of the kind of money I train "my boys" to make

\$50 to \$75 a Week



"The National Radio Institute put me in a position to make more money than I ever made in good times. I am in the radio service business for myself, where it is possible for me to make \$50 to \$75 a week. Service work has increased because people, who in normal times would buy a new Radio, now are contented to have the old one 'pepped up'."—BERNARD COSTA, 150 Franklin St., Brooklyn, N. Y.

\$500 a Year Extra in Spare Time



"Although only doing spare-time Radio work, I averaged about \$500 extra a year in addition to my regular income. Full-time Radio work would net me many times that amount. My example and that of hundreds of other N. R. I. graduates should convince any skeptical person of the superiority of N. R. I. training."—EDWARD H. FAWCETT, Slough Road, Ladner, B. C., Canada.



Averages \$80 per Month in Spare Time

"I am getting along well in my Radio work, always being kept very busy. Since enrolling I have averaged around \$80 a month working on Radios just part time, since I am still holding down my regular job."—JOHN B. MORISSETTE, 733 Somerville St., Manchester, N. H.

My Free book gives you many more letters of N. R. I. men who have made good in spare-time or full-time businesses of their own.

SPECIAL Radio Equipment for Broad Practical Experience Given Without Extra Charge

My Course is not all theory. I'll show you how to use my special Radio equipment for conducting experiments and building circuits which illustrate important principles used in such well-known sets as Westinghouse, General Electric, Philco, R. C. A., Victor, Majestic and others. You work out with your own hands many of the things you read in our lesson books. This 50-50 method of training makes learning at home easy, interesting, fascinating, intensely practical. You learn how sets work, why they work, how to make them work.

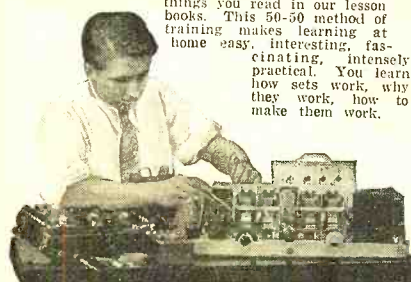

The world wide use of Radio sets for home entertainment has made many opportunities for you to have a spare-time or full-time Radio business of your own. I give you instructions early in your Course for doing 28 Radio jobs common in almost every neighborhood. Many N. R. I. men make \$5, \$10, \$15 a week extra in spare time almost at once. I show you how to install and service all types of receiving sets. I give you Radio equipment and instructions for conducting experiments, for building circuits and testing equipment, and for making tests that will give you broad, practical Radio experience. Clip the coupon below and get my free 64-page book, "Rich Rewards in Radio"—it gives you a full story of the success of N. R. I. students and graduates, and tells how to start a spare-time or full-time Radio business on money made in spare time while learning.

Free Book Tells How Mail Coupon!

Many N. R. I. Men Make \$5, \$10, \$15 a Week Extra in Spare Time Almost at Once

Many of the seventeen million sets now in use are only 25 per cent to 40 per cent efficient. I will show you how to cash in on this condition. I will show you the plans and ideas that have enabled many others to make \$5, \$10, \$15 a week in spare time while learning. Ford R. Leary, 1633 Davison Road, Flint, Mich., wrote: "My part-time earnings while taking the N. R. I. course were \$651."

Get Ready Now for a Radio Business of Your Own and for Jobs Like These

Broadcasting stations use engineers, operators, station managers, and pay up to \$5,000 a year. Radio manufacturers use testers, inspectors, foremen, engineers, service men and buyers, and pay up to \$7,500 a year. Radio dealers and jobbers employ hundreds of service men, salesmen, managers, and pay up to \$5,000 a year. Radio operators on ships enjoy life, see the world, with board and lodging free, and get good pay besides. Talking Movies pay as much as \$75 to \$200 a week to the right men. My book tells you of the opportunities in Radio, Talking Movies.

Set Servicing, Aircraft Radio, Television, Police Radio, Short Wave and other fields. Get it.

I Will Train You at Home in Your Spare Time

Hold your job until you're ready for another. Give me only part of your spare time. You do not need a high school or college education. Hundreds with only a common school education have won bigger pay through N. R. I. J. A. Vaughn jumped from \$35 to \$100 a week. J. E. McLaurine increased his earnings 100 per cent. The National Radio Institute is the Pioneer and World's Largest organization devoted exclusively to training men and young men by Home Study for good jobs in the Radio industry.

You Must Be Satisfied

I will give you an agreement to refund every penny of your money if you are not satisfied with my Lessons and Instruction Service when you complete my Training. And I'll not only give you thorough training in Radio principles, practical experience in building and servicing sets, but also Advanced Training in any one of five leading branches of Radio opportunities.

Free Book of Facts

Mail the coupon for "Rich Rewards in Radio." It's free to any ambitious fellow over 15 years old. It tells you about Radio's spare-time and full-time opportunities; about my training; what others who have taken it are doing and making. Mail coupon now.

Get my new book It points out what Radio Offers You

J. E. SMITH, Pres.
Dept. 3JR,
National Radio Institute,
Washington, D. C.



Special Free Offer



Act now and receive in addition to my big free book, "Rich Rewards in Radio," this Service Manual on D.C., A.C., and Battery operated sets. Only my students could have this book in the past. Now readers of this magazine who mail their coupon will receive it free. Overcoming hum, noises of all kinds, fading signals, broad tuning, howls and oscillations, poor distance reception, distorted or muffled signals, poor Audio and Radio Frequency amplification and other vital information is contained in it. Get a free copy by mailing the coupon.

THIS COUPON IS GOOD FOR ONE FREE COPY OF MY NEW BOOK

mail it TODAY

J. E. SMITH, President
National Radio Institute, Dept. 3JR
Washington, D. C.

Dear Mr. Smith: I want to take advantage of your Special Free Offer. Send me your two books, "Trouble Shooting in D.C., A.C. and Battery Sets" and "Rich Rewards in Radio." I understand this request does not obligate me. (Please print plainly.)

Name.....Age.....
Address.....
City.....State..... "M"

The Famous Course That Pays For Itself

S. GORDON TAYLOR
Technical Editor
 WILLIAM C. DORF
Associate Editor
 JOHN M. BORST
Ass't Tech. Editor



HOWARD S. PEARSE
Associate Editor
 SAMUEL KAUFMAN
Broadcast Editor
 JOS. F. ODENBACH
Art Editor

Edited by LAURENCE M. COCKADAY

VOLUME XV

September, 1933

NUMBER 3

CONTENTS

(Cover Design by Morey)

Radio on the Vatican <i>Frontispiece</i>	PAGE 134	A New P. P. Amplifier <i>By S. L. Baraf and I. A. Mitchell</i>	PAGE 146
Radio Echoes from Space <i>By Irving J. Saxl</i>	PAGE 135	A Shielded Lead-In System <i>By H. J. Adler</i>	PAGE 148
New Metal Tubes <i>By F. E. Henderson</i>	PAGE 138	Using Meter Analyzers <i>By Floyd Fausett</i>	PAGE 150
Is "Quality" Worth While? <i>By E. E. Free</i>	PAGE 140	Mathematics in Radio (Part 22) <i>By J. E. Smith</i>	PAGE 152
Short-Wave Hints <i>By Arthur J. Green</i>	PAGE 142	Servicing Receivers (Part 2) <i>By Joseph Kaufman</i>	PAGE 153
Home-Made Relays (Part 3) <i>By M. L. Wendel</i>	PAGE 144	With the Experimenters <i>By S. Gordon Taylor</i>	PAGE 154
Linear Rectification <i>By Frederic Siemens</i>	PAGE 145	A Portable P. A. System <i>By Leon Littmann</i>	PAGE 156

RADIO CALL BOOK SECTION

World S.W. Station List (Cont'd) <i>By the Staff</i>	PAGE 157	The DX Corner <i>By the Staff</i>	PAGE 164
Radio Program Features <i>By Samuel Kaufman</i>	PAGE 158	Service Data for Servicemen <i>By the Staff</i>	PAGE 166
Backstage in Broadcasting <i>By Samuel Kaufman</i>	PAGE 162	Technical Review <i>By Joseph Calcaterra</i>	PAGE 167

DEPARTMENTS

The Service Bench.....	PAGE 170
Students' Radio Physics Course.....	PAGE 172
What's New in Radio.....	PAGE 174
Latest Radio Patents.....	PAGE 176
What's New in Auto Radio.....	PAGE 178
QRD.....	PAGE 180

Published Monthly by Teck Publications, Inc., *Washington and South Avenues, Dunellen, N. J.*

OFFICERS

Lee Ellmaker, *President and Treas.*
 Warren P. Jeffery } *Vice Presidents*
 Huston D. Crippen }
 Abner Germann, *Secretary*

EDITORIAL AND EXECUTIVE OFFICES

222 WEST 39th STREET, NEW YORK CITY, N. Y.

Entered as second class matter at the Post Office at Dunellen, N. J., under the act of March 3, 1879. Copyright, 1933, by Teck Publications, Inc., in U. S. and Canada. All rights reserved. Title Registered at the U. S. Patent Office. Printed in the United States of America. The contents of this magazine must not be reproduced without permission. We cannot be responsible for lost manuscripts, although every care is taken for their safety.

25c a Copy, \$2.50 a year,
 \$3.00 in Canada, \$3.50 in
 Foreign Countries. Sub-
 scribers are notified that
 change of address must reach
 us five weeks in advance of
 the next day of issue.

Ship aboard a SCOTT ALL-WAVE *Deluxe* for a THRILL CRUISE 'ROUND THE WORLD

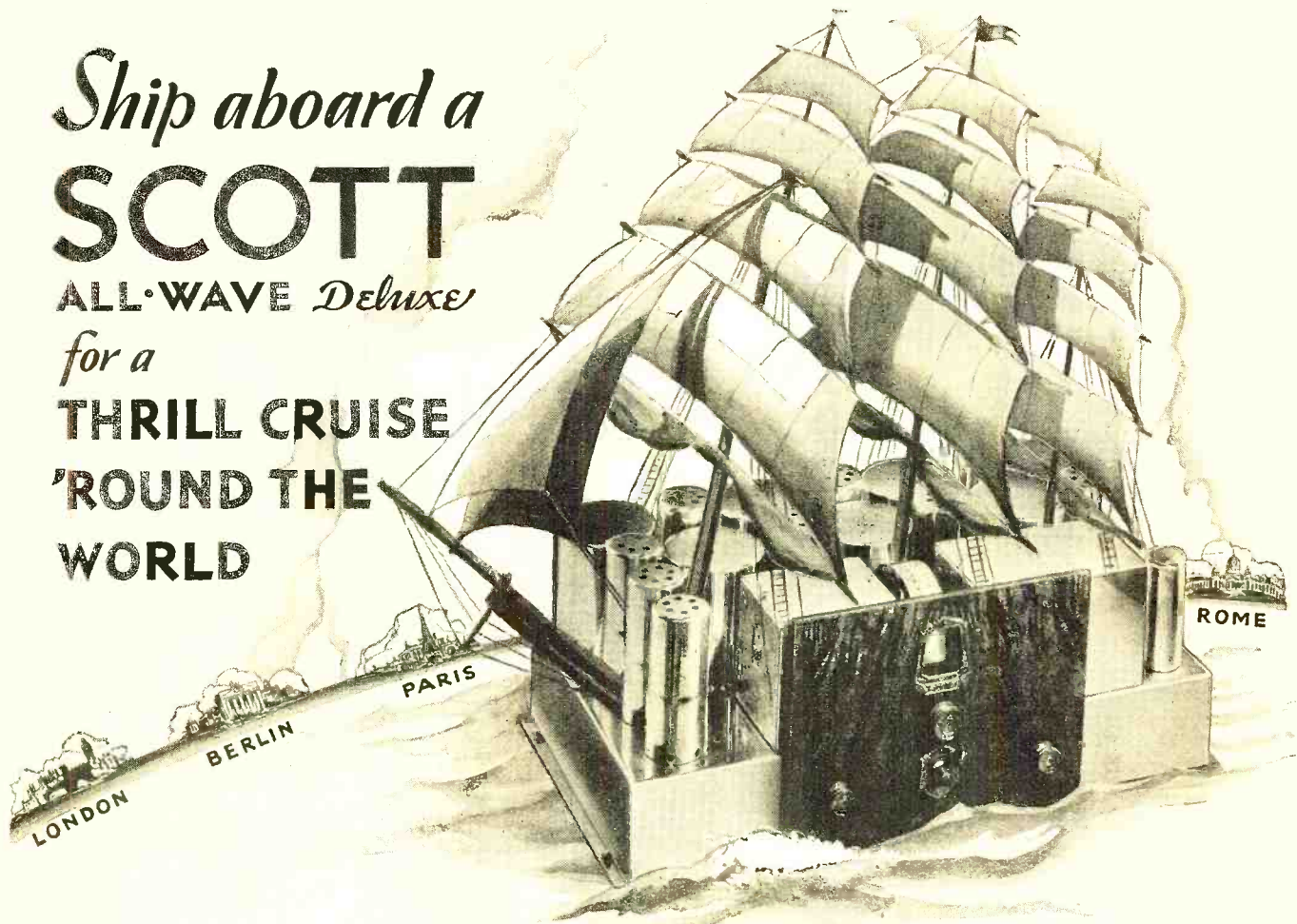

If you're an adventurer at heart (and aren't we all?) you'll glory in the thrills of cruising the ether-waves via a SCOTT ALL-WAVE *Deluxe* Radio.

Sit right in your own comfortable living room . . . there's no sea-bag to pack, no dunnage to stow, no passports to secure. Just the twist of a single, simple tuning dial and it's "Ho! You're off for strange lands of romance and allure!"

Supreme for Stay-at-Home Listeners

First a shake-down cruise in home waters. Listen in on American broadcast stations near and far—coast-to-coast is an easy jaunt. Discover the marvelous capability of this dream ship to carry you anywhere at your will . . . with a delightful fidelity of tone that puts you right into the sending studio, giving you every word of speech and every note of music with a glorious perfection that transcends all previous heights of mechanical sound reproduction. Your own ears will tell you so . . . and the evidence is backed up by scientific laboratory findings that prove SCOTT radio reproduction to be the closest to perfection yet attained.

As a first venture in short wave reception listen-in on the crime wave as reported by police calls from one end of the land to the other . . . eavesdrop on gossipy amateur wireless telephony "hams", and hear the air-planes and their ground stations talk back and forth.

Hear Canada and Mexico

Now venture farther! Roam the air-waves to Canada and Mexico. Hear something different . . . something typical of these near-by foreign lands broadcast on wave bands from 15 to 550 meters. Don't fret about the rumors you may have heard that these countries are soon to change wave-lengths . . . your SCOTT can be equipped to receive on all bands between 15 and 4,000 meters at a small extra charge.

Listen-in On All of Europe

And now you've "got the feel of your ship." Head out into the open . . . start on a fascinating exploration cruise for radio joys that are new and different.

Here's England, first! GSB, at Daventry, is sending out the news of the day for the benefit of Colonial

listeners-in . . . there's peppy music from a famous London hotel . . . and at signing off time (midnight in London, but only 6 P.M. Central Standard Time) the chimes of Big Ben, atop the Houses of Parliament, clang sonorously as though you were actually there to hear them in person.

Slip your moorings once again. Cross the Channel and lend an ear to Radio Colonial, Pontoise, France. It's bringing you Parisian music and typically French entertainment.

Varied Programs from Far Countries

Distance still lures you? Then set your course for Germany . . . in a jiffy you're listening to Zeesen, with programs of glorious symphony orchestras, and perhaps a speech by "Handsome Adolph" that will give you a different viewpoint on Hitlerism.

Make port at Madrid, in sunny Spain, and hear EAQ broadcasting typical National music. Announcements from this station are considerately made in English as well as Spanish.

Then swing south to Rome and hear the voice of 12RO's woman announcer tell you it's "Radio Roma, Napoli," that's on the air. Most likely the following musical program will be opera direct from LaScala, in Milan, or some other musical treat worth going actual miles to hear—and you'll be listening to it, with purity of tone and richness of reproduction that's truly amazing, without stirring from your easy chair at home.

And now for an adventure-trek that holds a supreme "kick" for the radio sensation-seeker! Sail away "down under." Listen in to VK2ME or VK3ME, in Sydney and Melbourne, Australia. Hear the call of that famous Kookaburra bird, listen with delight to an interesting and varied program of music and talks on the commercial and scenic attractions of the Antipodes.

Owners' Reports Show Real Ability

And these are but a few of the interesting places to be visited by means of your SCOTT ALL-WAVE *Deluxe* Receiver . . . F. L. Stitzinger, for instance, is a Scott owner who in a six-month's period received 1588 programs from 41 stations in 22 foreign lands. A. G. Luoma got 1261 programs from 75 different stations in 26 countries, and some 200 other SCOTT owners reported reception of 16,439 programs from 320 stations in 46 countries during the same time.

"Can such startling radio performance be true?"

you ask. Do you doubt that any but radio professionals can enjoy the delights of exploring the air-waves the world over, far from the too-familiar programs of broadcast stations here at home? Do you think that it may be possible, but feel that the cost of sufficiently able equipment is more than you can afford for entertainment?

New Value at Moderate Cost!

Then set your mind at ease! For such performance is actually possible . . . we gladly prove it to you, and back the proof by an iron-clad guarantee of consistent foreign reception.

Laboratory technique, employing the world's most skillful, specially trained engineers and craftsmen in custom-building a receiver constructed to the highest standards of perfection known in radio, makes possible the super-performance of the SCOTT ALL-WAVE *Deluxe* for any radio-user, regardless of his experience or skill in operating. In this set top efficiency is coupled with absolute simplicity of tuning.

Prohibitively high priced? Not at all! You can have a SCOTT, and enjoy the supreme thrill of mastering the air-waves of all the world, at moderate cost.

Get Complete Details—Mail Coupon!

Because the SCOTT ALL-WAVE *Deluxe* is one of the truly fine things of the world, custom-built for those discriminating people who demand the best, it is not distributed broadcast, to be casually picked up here, there, or anywhere. To get full particulars regarding it, absolute PROOF of its performance, and all the information you require, simply send the coupon below direct to the modern scientific laboratories where it is built.

E. H. SCOTT RADIO LABORATORIES, INC.
4450 Ravenswood Ave., Dep't N-93, Chicago, Ill.

Tell me how I can have a SCOTT ALL-WAVE *Deluxe* to take me radio world-cruising. Include all technical details, proofs of performance, and complete information.

Name.....
Address.....
City.....State.....

The Editor—to You

THE purchase of radio sets, radio parts, tubes and accessories is an investment—now! Prices for radio apparatus are now at bottom, as the manufacturers, during the recent period of depression, have had to compete with each other from a price standpoint and production methods are at their peak of efficiency, while raw materials have been procurable at less than cost.

* * *

THIS condition is rapidly approaching an end! Raw materials are exhausted and the prices for new raw materials for the manufacture of new radio apparatus in the future will be found at higher and higher levels. This is forcing the manufacturer, during the next few months, to raise prices in general, and if a code of fair competition and marketing operations is agreed upon—and it is almost certain be, in the radio industry as in other industries—radio apparatus in general is bound to sell at higher levels. So, for anyone in need of the finished products, whether complete receivers, transmitters or parts and accessories, the time to buy is the *immediate present*.

* * *

For the ordinary individual who has been thinking of getting a new receiver, now is the time to investigate and purchase. For the DX fan who needs a new set of tubes to replace "worn-outs" or for the necessary "spares" for reliable DX reception, for the experimenter who needs new parts and accessories for work he has in contemplation, for the engineer and designer who needs new equipment for working out new designs, for the serviceman whose stock of replacement parts is falling low, for the laboratory technician who desires more apparatus in the way of measuring equipment, meters, oscillators, frequency standards, signal generators, etc., as well as for the beginner in radio who wishes to make his first purchase of radio equipment at favorable prices, now is the time to buy! For the DX fan who has been considering for some time the advisability of purchasing one of the new and quite marvelous developments in short-wave or all-wave receiving sets, now is emphatically the time to buy! For the ordinary home listener who wants a new set for his home, whether large or small, today's market offers an exceptional opportunity. And for the automobile owner who has been considering the purchase of an automobile radio, now is the last call at such favorable prices.

* * *

At no time in the past, and, the editors believe, at no time during the next few years will the American dollar purchase so great an amount of efficient radio apparatus as now. Look through the present issue of RADIO NEWS and

you will find hundreds of items that are selling today at figures that may be doubled during the next few months. You can't go wrong in a decision formed affirmatively in connection with a purchase of radio apparatus within the next thirty days.

* * *

HAVE you got that new set for entrance into the lists for the coming World Champion DX Contest? The editors refer to the Denton Trophy Contest, sponsored by the International Short-Wave Club. You will need the best in receiver equipment, as well as antenna equipment and tubes, to place you at the head of the growing list of

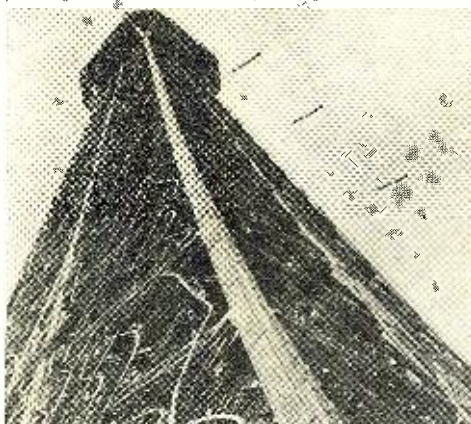

entrants into this interesting contest.

* * *

THE preliminary rules for this contest were given last month in the DX Corner of RADIO NEWS. In regard to this department, the editors are glad to note that the reader response to this material has always been enormous, but during the recent two months it has been growing almost unbelievably. Appointments of Official Listening Posts are being made as this editorial is being written, and all reader listeners who wish to be considered for further honorary appointments should send in their letters of application, together with a sample log of reception of short-wave stations, for consideration.

* * *

THERE have been received to date over 150 applications in the United States and foreign countries. These appointments are still open for a few states in the U. S. and for appointments in Europe, Australia, South America, Africa and the Orient. Be sure that you give this immediate attention.

THE photograph reproduced on this page shows the antenna installation on the top of Eiffel Tower, Paris. This is for the high-power, high-wave International broadcasting station with call letters FL. The antenna wires, which can be seen sloping down from the tower, run to a height of almost a thousand feet, probably making this the highest antenna in the world. We are wondering if any American listeners have been able to pick up the transmissions on this side of the Atlantic.

* * *

COMING over the Editor's desk this month are an increasing number of letters from readers. A few excerpts from these are printed below:

* * *

"RADIO NEWS is the most popular American radio publication in this part of the world, and if you continue to publish such interesting and valuable material its popularity will increase steadily. RADIO NEWS is of great assistance to the dealer and serviceman who wishes to keep abreast of the times."—Edward Chan, Radio Department, China Emporium, Ltd., Hong Kong, China.

* * *

"I AM extending my sincere congratulations on the excellent balance of your articles in RADIO NEWS, for people connected with the radio industry or only from a listener's viewpoint. The issues of RADIO NEWS are improving, each month, so much that I have discontinued buying or subscribing to other periodicals pertaining to the radio industry."—J. F. Schmieskors, Manager, Electrical Department, Boulder City, Nevada.

* * *

"CONGRATULATIONS on your article by Edward M. Glaser in the March issue. He seems to have a peculiar facility for explaining things in a way that makes them easily understandable. You ought to have more articles by him."—S. P. McMinn, Editor Automotive Merchandising, New York City.

* * *

"WE depend on RADIO NEWS to keep us informed on the latest developments in the constantly changing field of radio. We are especially pleased to read the article on Marine Radio by Arthur Ransom. Hope that you will publish more of a similar nature. The QRD column is quite interesting."—C. N. Harris, chief operator, Sydney L. Taylor, assistant operator, S. S. Borinquen.

Stewart M. Lockaday

A Thrilling Tale For Vacation Days

SELECT a comfortable chair in a cool spot, folks, and read your combined August-September issue of *Wild West Stories and Complete Novel Magazine*. This month's complete novel is "Crooked Trails" by George Brydge Rodney. And what a wow of a story it is! Here's how the author describes the scene shown on this page:

"A short, stabbing jet of flame leaped from the loose blanket over Dustin's arm. A flat, smacking report like the noise a plank makes in falling on quiet water jarred the desert night. A little skirl of white smoke eddied from the end of the blanket, and old Kane—old and very wise Ulysses of the foothills, sank to his knees and slowly rolled over on his face while his claw-like hands worked convulsively. Then he lay still!"

Read "Crooked Trails"

"Crooked Trails" of lawless men! Undercover cattle rustling that almost brought ruin to the "Hour-glass" ranch! Murder to prevent exposure! Death to the man who discovered a gold mine! Planted evidence on a wretched dope-fiend that almost caused another murder! Right fighting against might! Romance amid ruination!

"Crooked Trails" is a full book length story that will make summer heat disappear—a tale that will transplant you to the glorious West where hard-riding cowboys give battle to outlaw cattle rustlers—where romance buds amid gunfire!

Read "Crooked Trails" by George Brydge Rodney. See for yourself why thousands of people eagerly await each new issue of *Wild West Stories and Complete Novel Magazine*. Buy a copy of the combined August-September issue.

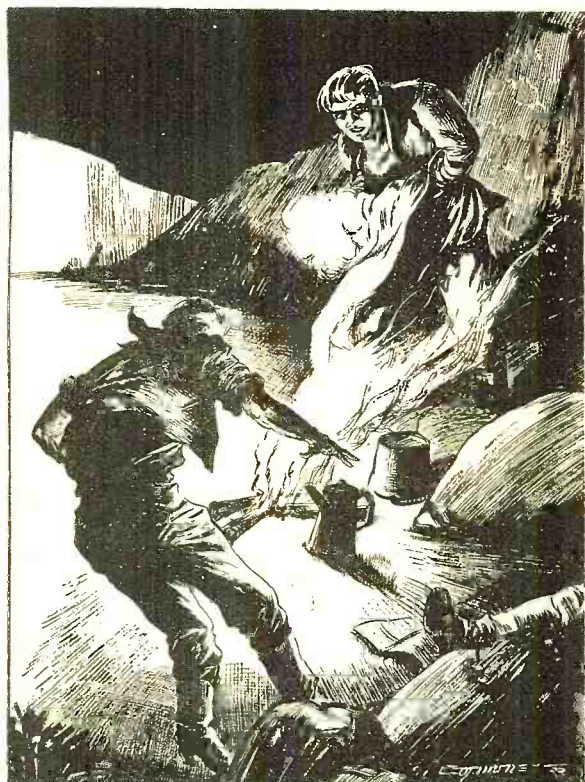

Trial Subscription Offer

You can save money by taking advantage of a special subscription offer. Send \$1 to Teck Publications, Inc., 222 West 39th St., New York City and receive the next five issues of *Wild West Stories and Complete Novel Magazine*. Each issue will contain a new, book-length western novel and numerous short stories.

In The August-September
Wild West Stories
 and
Complete Novel Magazine
25 Cents At All Newsstands

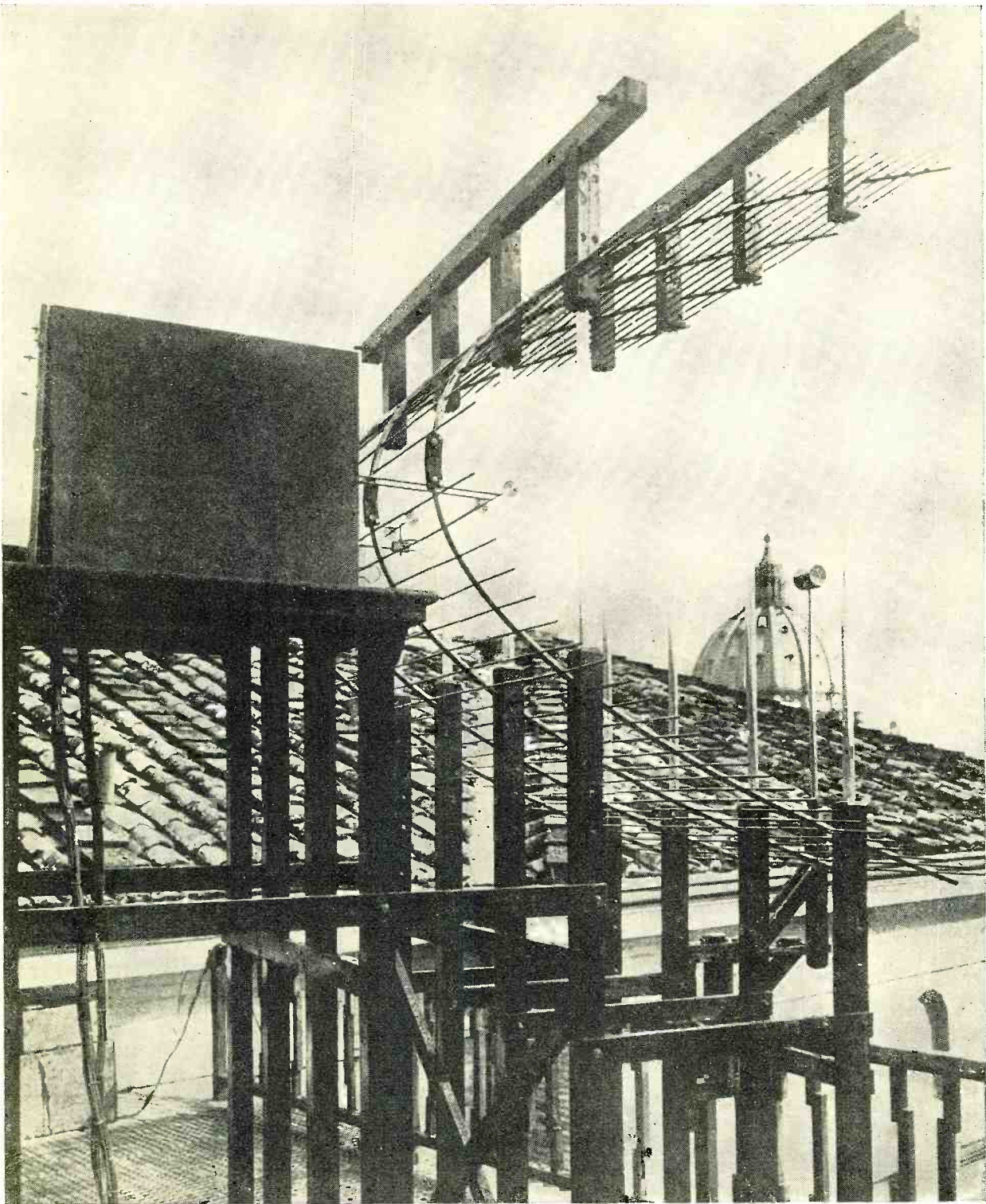

Signals That Are Not Reflected by the Earth's Atmosphere

Here is a picture of the unique Marconi transmitter and reflector type doublet antenna working on a wavelength of 50 centimeters. This installation is used on a balcony on the top of the Vatican in Rome, Italy. The waves from such a transmitter penetrate the earth's atmosphere without being reflected again to earth.

Radio News

VOLUME XV

September, 1933

NUMBER 3

RADIO ECHOES *from* SPACE

Just what is it in the atmosphere surrounding our world, or above it, that makes possible the transmission of radio signals around the earth's curvature? The author, in this interesting article, reviews some of the current theories of these reflections or echoes of radio signals from outside space, linking transmitters and receivers at great distance apart on our globe

IN the City of Buenos Aires there is in operation a device for the transmission of radio telegraphy and telephony which resembles a huge plane parabolic reflector approximately twenty feet long and eight feet high. It is built of wood and covered inside with metal foil. In the focus of this reflector there is a bi-pole antenna. The interesting thing is that this reflector points *toward the sky*, its axis at an angle of approximately $22\frac{1}{2}^{\circ}$ with the horizontal level of the surface of the earth, as though its rays should shoot upward into the atmosphere for communication with some unknown being on another planet. Curiously, however, this unknown being speaks with a strongly German accent. As a matter of fact, the correlating station which is addressed by this reflector in the South American City, is not outside of the globe of our Mother Earth at all, but is near Berlin—in Koenigswusterhausen, and the physical fact which made possible this unusual way of communication between these two points is perhaps the one which is the most important today for general long-distance communication between two points, namely, the existence of a reflecting layer in the upper atmosphere, called after its investigators, the Kennelly-Heaviside layer.

If there exists any preference between the various planets of our solar system, from a radio standpoint it is that the layers which surround the earth seem to be the only ones from which short

By Irving J. Saxl, Ph.D.

waves can rebound and thus make it possible to reach receiving stations many thousands of miles distant from the shortwave transmitting station.

It is probable that on no other planet of our solar system would radio communication on short waves be possible, because such layers cannot be built up there, due to the lack of our typical atmosphere. We humans of the 20th century should consider ourselves rather fortunate that we are living upon an earth that is surrounded by this type of atmosphere. We radio short-wave fans should be thankful because it is this fact that brings about the reception of signals from around the world.

How does this transmission take place? Long after Hertz and later Marconi made their fundamental experiments, it was stated (and proven theoretically) that a communication from point to point could be made only with radio waves of considerable wavelength which fol-

lowed the curvature of the ground without being absorbed too much. In the early days of radio transmission, particularly in over-seas services, it was the usual thing to apply wavelengths up to several miles. Tremendous power was necessary at such wavelengths and the development of radio-transmitting apparatus, at that time, centered around the point of increasing the energy of the transmitting machines and enlarging the height and length of the antenna, the signal intensity at the distant point being, among other

THE OLD THEORY OF RADIO ECHOES

Figure 1. This diagram shows the reflecting layer and the method by which distant transmission and reception was thought to occur as the result of a single or multiple reflection of sky waves

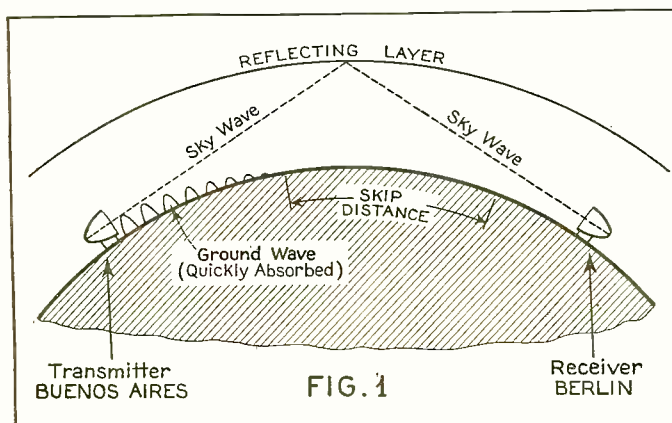

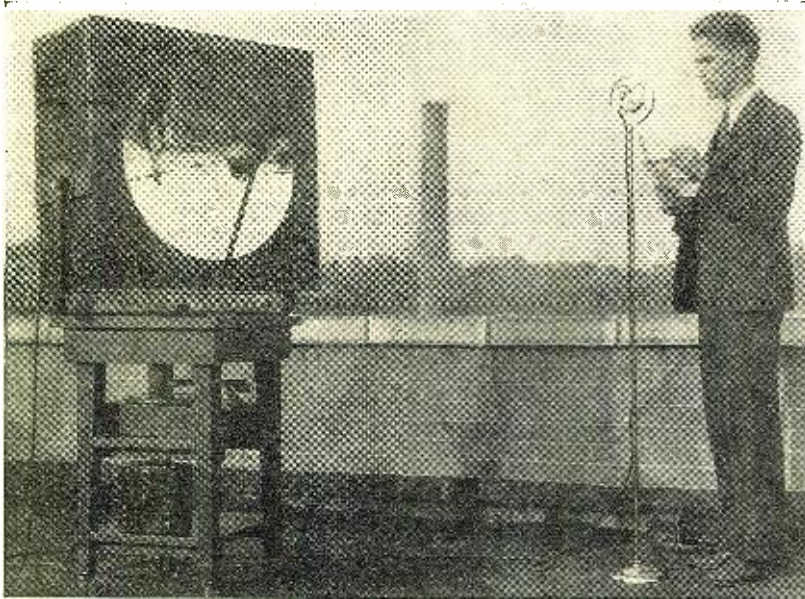

"BEAM-CASTING" ON 9-CENTIMETER WAVES

During trials of the above pictured apparatus, developed at the Westinghouse plant at E. Pittsburgh, speech and music were transmitted, with indications that reception by this system is possible at a distance of at least 20 miles. These waves are not reflected by the Heaviside layer.

reduced pressure, become conductors of electricity. If they are bombarded by electrons streaming out from the sun, we have the heavenly luminous discharge tubes called the Aurora Borealis. And, as they are conductors of electricity, they are, like other conductors, able to reflect radio waves of certain wavelengths. Of course, they are not quite as good conductors of electricity as, for instance, copper or silver, and so this reflection is not a perfect one, but more of the type of a gradual refraction.

The layers of the atmosphere surrounding our earth are not homogeneous, but are considered to consist of layers of various dielectric properties and different electrical conductivity, both of which factors have a definite relation to the specific propagation of electromagnetic waves of various wavelengths.

In 1900 Lenard had already shown that ultra-violet light is able to ionize gases of various types by its direct influence upon its smallest composing parts.¹ He had shown that such light can split up atoms. Moreover, the phenomena of the Aurora Borealis, of the Northern Lights and other facts of atmospheric phenomena, have proven that there are regions in the upper atmosphere where irregularities occur. It was as early as 1882 that Stewart considered the daily variation of the earth's magnetic field as a proof of the existence of a conducting layer in the upper

things, directly proportionate to the power of the transmitter and the height of the antenna.

At that time only negligible power could be produced on the short wavelengths, which, moreover, were found to be more strongly absorbed in the ground, and thus they were considered to be out of the question for reliable communication purposes. Therefore these short waves were "given" to the amateur to work with, and we have to thank the persistency and ability of these early amateurs for the present developments of long-distance communication with greatly simplified means, both in constructional details worked out and in expenditures. Experimentation of this sort has finally made possible a service to humanity which seemed ridiculous to the early theorists. It proves again that we must *not put too much confidence in theories alone!* Theory, after all, can express only as much as the actual facts entering into it. And sometimes there are many facts missing. But let us confess humbly that our knowledge of facts in this vast unexplored region of natural phenomena is small. It is only within the last decades of our thousands of years of civilization that we have begun to investigate nature systematically.

The fact which was not included in the early electromagnetic theories about the phenomena of radio transmission was that any other possibilities for radio transmission—outside of a wave traveling along the ground—was neglected.

Similar to the neon in advertising signs which illuminate Broadway at night, the gases of the upper atmosphere, at

atmosphere. The existence of the Heaviside layer is now daily proved in several countries and its heights and the density of its charge is regularly measured. In addition, this information about the state of the upper atmosphere, regions where no sounding balloon can penetrate, may some day become useful in forecasting the weather. Considerable material on this subject was collected by Harlan T. Stetson, whose chief interest was primarily astronomy. As far as one hundred years ago this idea was also conceived by the British economist Jevons. A book was written on the subject by Ellsworth Huntington. Its title is "Earth and Sun." And it was Sir William Beveridge who made forecasts of wheat prices, based upon similar considerations. The series of experiments made between the transmitter of the Naval Research Laboratory and the receiver in the Department of Terrestrial Magnetism in Washington, D. C., were important. During the period from December 19, 1927, to January 16, 1928, signals of very short duration were investigated by G. Breit, M. A. Tuve and O. Dahl.²

Reflector Action Varies with Wavelength

While the extremely short waves, like light, for example, can penetrate these gaseous layers, they act as a reflector similar to metal for somewhat larger waves.

This layer of varying electric behavior is produced, according to the present state of our knowledge, by three actions:

- (A) Electronic bombardment

INTERDEPENDENCE OF SUNSPOT NUMBERS AND FADING OF RADIO WAVES

Figure 2. These curves show the relation between radio signal intensity (lower curve) and inverted sunspot numbers (upper curve) after Stetson. Figure 3. A comparison between the 1930-31 sunspot numbers (Wolf numbers) in comparison with the intensity of signals from station WBBM, at 770 kilocycles, received at Delaware, Ohio (after Stetson). Figure 4 shows how multiple reflections may cause phase shift at the receiver to produce fading. Signals passing between the transmitter T and the receiver R over two paths arrive out of phase and thus cancel each other

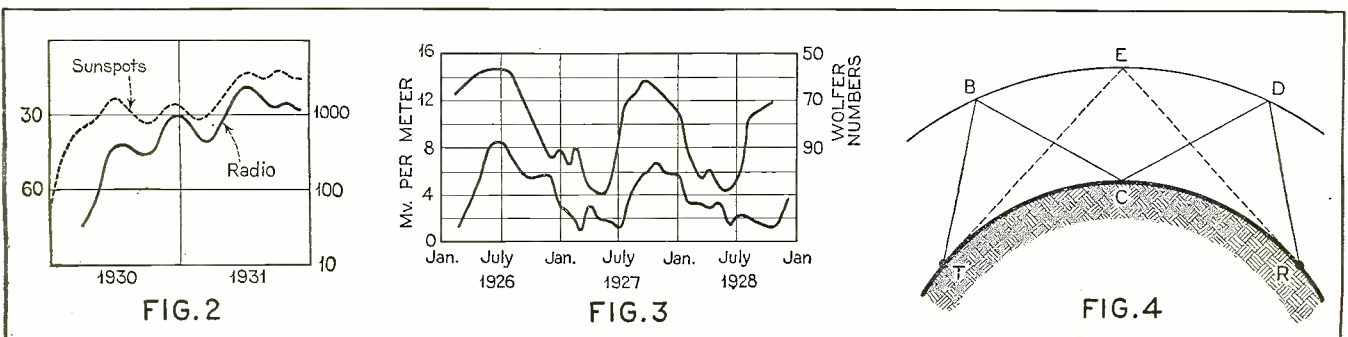

- (B) Ultra-violet light and
- (C) Cosmic rays.

The last influence—cosmic rays—is of the most penetrating, hardest type, being quantitatively absorbed only to a very small extent and therefore producing little ionization. However, while this total reaction is a small one, its quantitative distribution may become of importance in investigations pertaining to the upper layers of the stratosphere. There is reason to believe that the application of such investigations may become of value in later years when stratospheric aeronautics may have passed the stage of experimentation and become a reality of daily life. For recording of these cosmic rays apparatus similar to the one described on page 527 of the March, 1933, issue of RADIO NEWS may be used.

As to ultra-violet light and electronic bombardment, these phenomena have a relation to the action of the sun for creating the ionized layers. Both ultra-violet light and electronic bombardment are believed to be important in creating the layers. At the present time, the effect of ultra-violet light seems to be in the foreground. Particularly during the last eclipse, measurements have been made by various investigators which seem to prove that the influences of the electronic eclipse upon the reflecting layer are small in comparison with the optical eclipse. A final conclusion has not been reached as to which of these two theories is of greatest importance. It is interesting to note, however, that there is a connection between the variations in the earth's magnetic field, sun spots, the emission of electrons from the sun, and the intensity of radio signals. It seems that the electronic disturbances which bring about changes in terrestrial magnetism and produce the heavenly displays of the Aurora are able also to markedly influence the Kennelly-Heaviside layer. An *outburst of solar activity*, such as takes place by an increase of sun spots, "lowers" the Kennelly-Heaviside layer. Heavier ionization of the outer layers of the atmosphere occurs and the total Kennelly-Heaviside layer is said to move toward the surface of the earth.

Sunspots and Radio

Changes in solar activity, as demonstrated by sun spots, have a relation to changes of the earth's magnetic characteristics, both in regard to their intensity and direction.

Amplitude and duration of disturbance in short waves, as shown in the field intensity at the receiving points, are considerably greater between points where the communication passes near the earth's magnetic poles than, for instance, the communication line between New York and Berlin. Such lines which have a communication parallel to or in the neighborhood of the equator, as, for instance, Berlin to Cairo, have

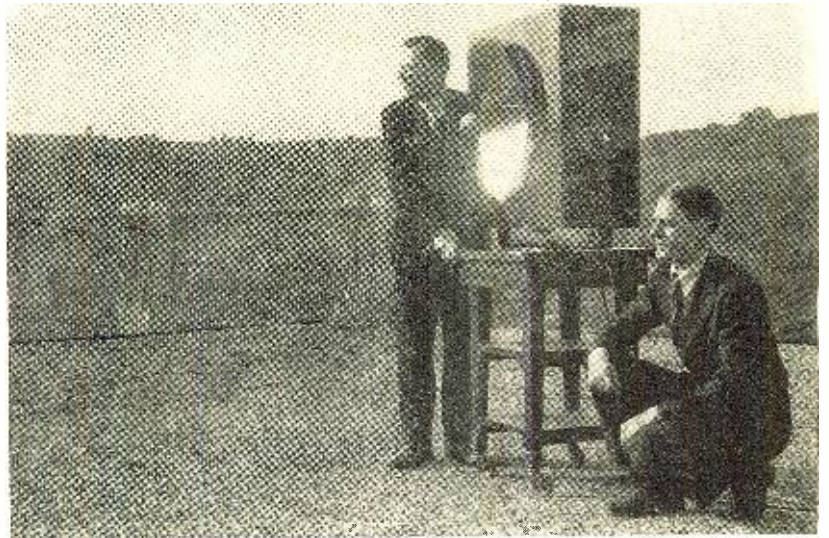

RECEIVING 9-CENTIMETER WAVES DURING TESTS

The receiver set-up, showing the reflector, for picking up ultra-short waves from the transmitter shown on opposite page. The tests show that signals are not disturbed by atmospherics, man-made static, fogs, sleet or rain.

been proved to be less affected by such disturbances. Considerable statistical material on this effect has been published by H. Mogel.³

The correlation between radio intensity and sun spot numbers is shown graphically in Figures No. 2 and No. 3.

It is perhaps more than an accident that, just now, interest in long-distance reception is increasing so rapidly. It is not only that the highly perfected radio sciences, the new tubes and circuits, have made possible the construction of apparatus which does give efficient short-wave world reception, but, in addition, that we are approaching a *period where sunspot activity tends toward a minimum and therefore long-distance reception is getting better and better*. This condition will last another few years. Thereafter, the sunspot activity will increase again and it may be predicted with reasonable certainty that the long-distance reception will then slowly suffer.

Figure 1 shows schematically how a signal travels, according to the older theories which assume only one perfectly reflecting gaseous layer. After a considerable distance, the *skip distance*, the signals fade out. Farther on, they come in again. It becomes clear that such waves have not been transmitted along the ground; they must have been reflected from somewhere up in the sky.

Figure 4 shows schematically how fading is produced. The transmitter, T, emits waves which travel either over the path, TBCD, to the receiver, R, being (Continued on page 182)

TWO THEORIES DEALING WITH THE TRANSMISSION OF LONG-TIME ECHOES

Figure 5. This diagram illustrates the idea of hypothetical clouds of electrons way out in space, at least as far away from the earth's surface as the moon, reflecting radio waves back to earth after a number of seconds' interval. Figure 6 illustrates another new theory, embracing the idea of two conducting layers around the earth in which radio signals may become "trapped," producing retardation of the signals from the time they enter the layers to the time they are reflected back earthward

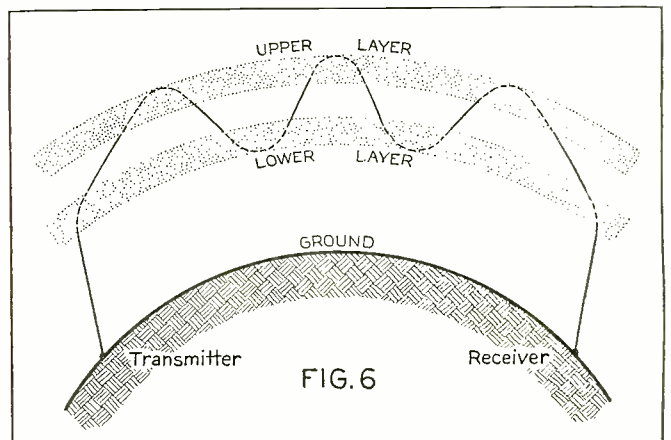
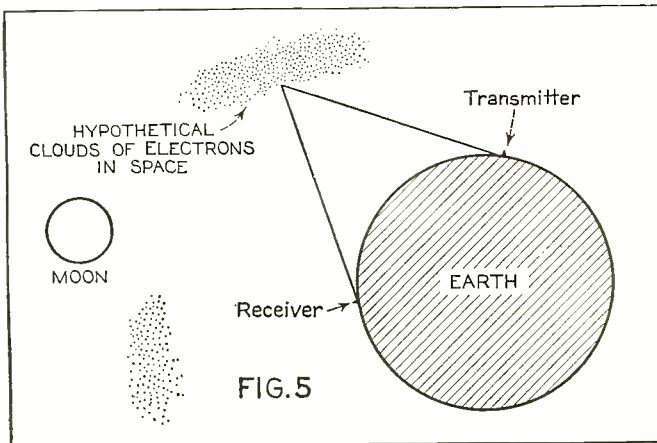

DISCARDING TRADITION IN DESIGNING THE

NEW METAL TUBES

The vacuum tube began life as a poor relation of the electric incandescent lamp, and one of its essential parts is still a piece of electrically heated metal enclosed in a vacuum. In these new tubes that is about the only recognized survival of the original construction

By F. E. Henderson

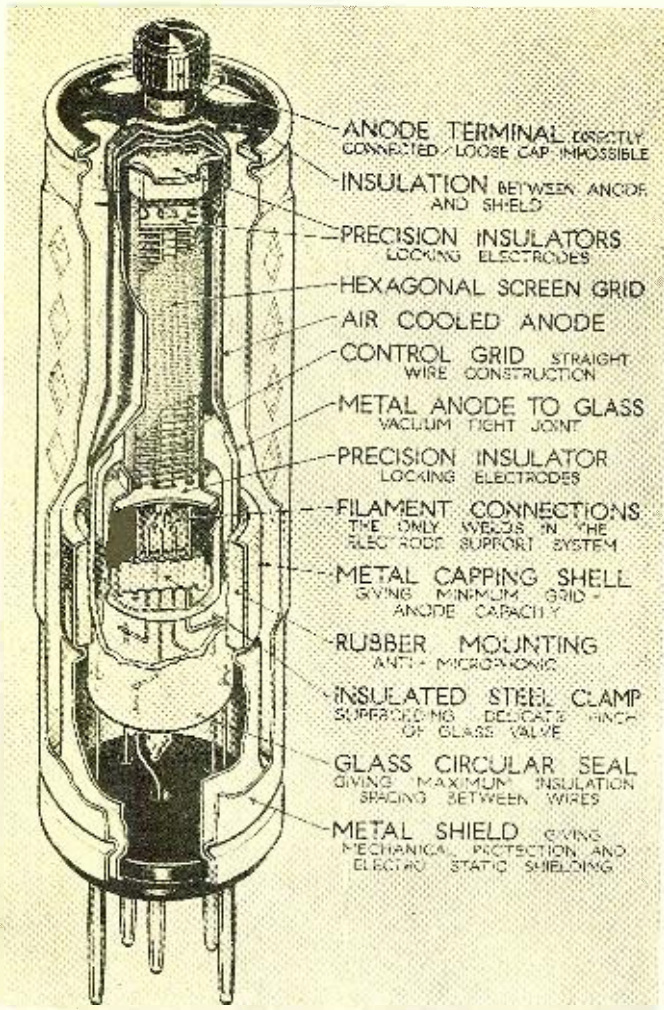

CUT-AWAY VIEW SHOWING CONSTRUCTION

Figure 1. The newest mode in vacuum tubes, showing the glass-to-metal joint, external air-cooled anode, rubber mounting ring, steel clamps for holding elements and the external metal shield and container

SOME remarkable claims are being made for a new type of receiving tube developed in England by the General Electric Company, Ltd. This is the so-called Catkin, manufactured under the Osram label, incorporating some entirely novel features of tube construction which have given rise to the term "unbreakable." Certainly tests have shown that the metal construction of this new tube is built to stand knockabout treatment such as would soon cause the early demise of the glass tube.

The two points of outstanding interest which strike the layman at once are, first, the abolition of the customary glass bulb and, second, the appearance of a ventilated metal can which completely encloses the tube, making it look not unlike some forms of electrolytic condensers in shape and overall dimensions, as shown in Figure 3. The actual plate is found on the outside of the tube just underneath the metal shield and

three views of this construction are shown in Figure 2 for various types of receiving tubes. The outer shielding metal cap is optional and the tubes can be obtained in the form shown in Figure 2. Intrinsically, however, there is very much more than strikes the eye in this new receiving tube and one of the most interesting technical points is the abolition of the customary glass "pinch" through which the usual metal supports for the elements are passed. This glass pinch has been employed as a means of support for the various electro-holding wires ever since the inception of the vacuum tube. It is a natural inheritance from the familiar form of electro-lamp construction. By the abolition of the glass pinch and its substitution by a steel and mica clamp, all the traditional methods of tube manufacture have been discarded and the vacuum tube at last stands "on its own pins" as a complete and separate engineering entity, having severed all relations (with the exception of the vacuum) with the electric lamp.

Perhaps a description of the constructional points of this new tube could best be covered by a review of the processes of its manufacture, which can be followed in the cut-away diagram of Figure 1.

The electrode system is built up from its component parts consisting of the heater, cathode and grid in the same way as for a normal tube, but with one important difference, namely, that no bent wires are used in the electrode supports; each part consists of a rigid structure with straight supports; each fits into the adjacent electrode by the use of accurately machined mica spacers so that the electrode clearances can be maintained to a far higher degree of accuracy than in old methods of construction, and the completed system makes a

CHARACTERISTICS OF OSRAM "CATKIN" TUBES

CATKIN VMS4 VARIABLE-MU, SCREEN-GRID A.C. TUBE	CATKIN MS4B SCREEN-GRID, A.C. TUBE	CATKIN MH4 TRIODE, A.C. TUBE	CATKIN MPT4 PENTODE A.C. OUTPUT TUBE
Filament Volts.....4.0	Filament Volts.....4.0	Filament Volts.....4.0	Filament Volts.....4.0
Filament Amps.....1.0	Filament Amps.....1.0	Filament Amps.....1.0	Filament Amps.....1.0
Plate Volts, max.....200	Plate Volts, max.....200	Plate Volts, max.....200	Plate Volts, max.....250
Screen Volts, max.....80	Screen Volts, max.....80	Amplification Factor...40	Screen Volts, max.....250
Transcond., max. 2400 Micromhos	Transcond., 3200 Micromhos	Transcond., 3600 Micromhos	Power Output.....8 Watts
			Transcond., 3000 Micromhos

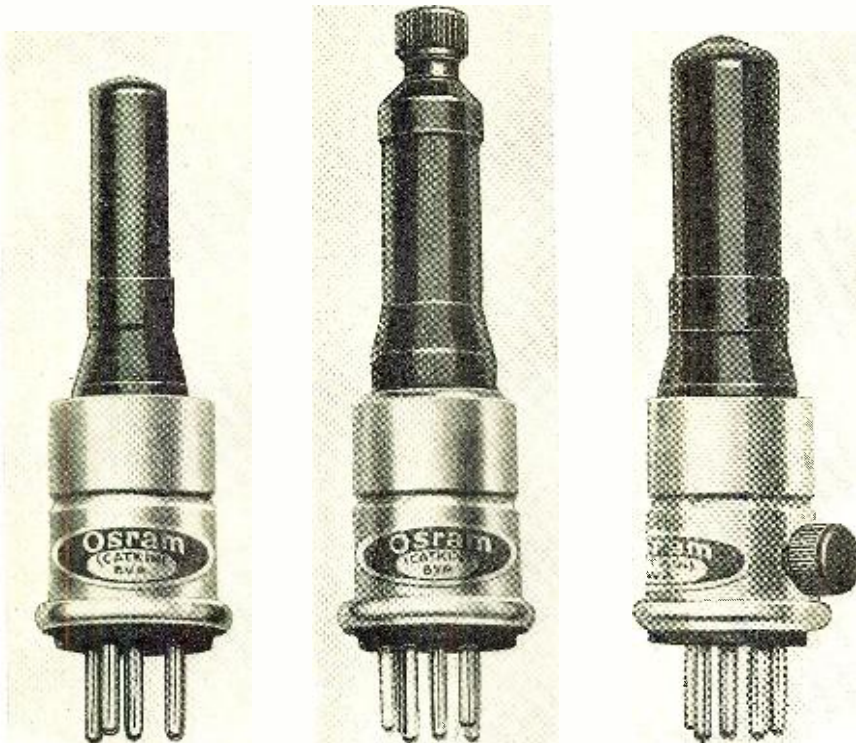

METAL TUBES WITHOUT EXTERNAL SHIELDING

Figure 2. The first tube at the left is a triode type M114 with the copper anode showing above. The center tube represents the type VMS and MS+B screen-grid tubes with the plate connection on top. The right-hand tube is the type MPT4, a pentode. All tubes are for a.c. operation

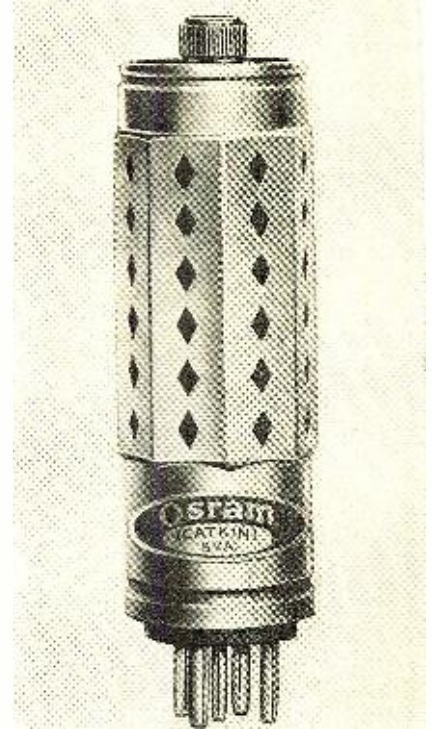

EXTERNAL APPEARANCE

Figure 3. This illustration shows the screen-grid type of tube with external metal shield surmounted by the plate connection

rigid and compact whole. The straight electrode support wires with mica insulation between them are then pinched in a steel clamp by means of a hydraulic press, giving a construction involving no spot welds whatever in the plate and grid support system. The only spot welds employed within the electrode system, actually acting as supports, are those joining the heaters to their lead-out wires.

The next step is the welding of the glass foot tube to the copper anode. This is done on revolving lathes with gas jets applied to the glass and copper so that by combined actions of heat and centrifugal force the glass can be made to form a complete vacuum and airtight joint to the copper thimble.

Assembly

The whole electrode system is then inserted into the copper anode into which it fits tightly by means of accurately spaced mica pieces, again making a rigid and compact unit.

The glass exhaust tube incorporates a circular seal through which the lead-out wires from the electrodes are passed and sealed, the circular form giving much wider spacing and therefore lower capacity between electrodes than in the normal pinch construction.

Finally, the whole system is fitted into a metal base, not by the usual capping cement but by means of a tightly fitting rubber ring which imparts resiliency and holds the base with a lasting and tenacious grip.

At the present this new tube is

being made only in the form of the most popular a.c. types commonly used in English sets and comprises a high amplification triode, two screen-grid tubes, one of them a "variable-mu" type, and a high-efficiency output pentode.

In England, as is well known, the top connection in screen-grid tubes is that of the plate and not the control grid as in America, so that this new design lends itself particularly well to this form of connection.

Incidentally, the name Catkin, with which the new construction has been christened by its makers, is a derivative from the cooled-anode transmitter tubes, or, in short, CAT's, of which this little receiving tube is a diminutive example in certain aspects of its construction.

Indestructible

Although we do not normally expect to treat vacuum tubes as footballs, it has been demonstrated that these Catkins can be flung from one end of a shop to the other and stamped upon until the pins are bent, without in any way impairing the efficiency and performance. You can hit it with a bat for a "homer" and it will still bring in DX without a blink!

Observers have seen sacks full of these new Catkin tubes dumped out on a stone floor as if they were coal. They have seen samples from these picked at random and used immediately in an amplifier to be found in perfect working order. A sample also was shown that had been (Continued on page 187)

THROW IT THROUGH A WINDOW

These new metal tubes survive being thrown through plate glass without in any way being impaired by this drastic treatment. Arrow points to tube after contact



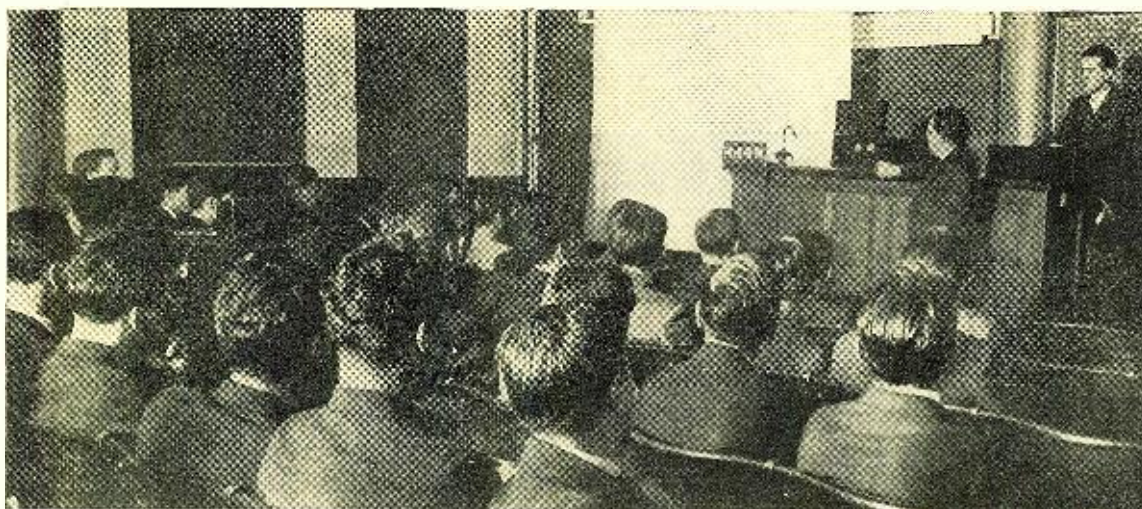

THE TEST SET-UP DURING ONE OF THE LISTENINGS

Here is reproduced a portion of a group of about sixty-five listening to one of the playings. The sound screen is at the left of the lecturer's desk and the four switches, the sound intensity measuring device, the microphone and the phonograph turn-table can be readily located

Is Good Quality Worth While?

A report of a psychological test at New York University on individual preferences of ten groups of university students. The results of which may be considered of importance in the radio industry

DISCOVERING just what the American public prefers in radio sets has proved to be a matter of no small difficulty. Sales records involve too many factors to be disentangled; price, appearance, good or bad advertising, manufacturer's reputation and so on, all quite independent of technical considerations such as musical quality or selectivity. Preference tests carried out by letting audiences or individuals listen to different sets and indicate their judgments, useful as these tests may have been, always have been recognized as open to certain quite definite psychological objections.

It was to test at least one of these psychological objections that the experiment which it is the purpose of this article to describe was planned and carried out in connection with the general science courses in the School of Commerce, Accounts and Finance of New York University and under the direction of the instructional staff for these courses, consisting of C. C. Clark, Ph.D., L. M. Cockaday, C. A. Johnson, C. E. Budenbender, G. William Henninger and myself, together with the advice and aid of Norman L. Hoopingarner, professor of psychology.

The kind of preference test commonly used for radio sets is better known, I imagine, from the tests conducted and widely advertised on four popular brands of cigarettes. A small crowd of people is assembled in any convenient way and each smoker in the crowd is handed four cigarettes in succession, one of each of the four popular brands included in the test. Names and other visible characters are concealed so that the smoker presumably does not know which brand he is trying. Statistical results are said to show a considerable excess of preferences for the brand of cigarettes sponsoring the tests over the three other brands included. Had the results been otherwise, the public presumably would not have heard of them.

These tests are said to have been conducted under the eye of competent accountants of unquestioned integrity. So far as I know, no one has suggested that the numerical preferences were in any way faked. There has been urged against these tests, however, one of the psychological objections applicable in theory to all such preference tests. It is alleged that one

large item controlling all such tests is the order in which the cigarettes or other articles are presented for judgment. It has been claimed, for example, that most people tend to prefer number three in any list of four articles presented to them for judgment, more or less regardless of any real difference in quality. If this be true, all that is necessary to have your particular brand of cigarette approved by the majority of voters is to be sure to have it presented as number three in the set of four possible choices.

Modern psychological science has uncovered and unquestionably proved so many such curious and utterly unreasonable quirks of the human mind that there is nothing improbable

about this theory. If it is true, it means that virtually all such preference tests are useless, including the tests made similarly on four or more contrasted radio sets. It seemed to be desirable, therefore, to test this theory, and something more than four hundred students in the science courses mentioned supplied convenient test material. To borrow the recent phrase of Messrs. Kallet and Schlink, but without its opprobrious implications, these students provided four hundred useful and willingly co-operative guinea pigs.

Most of the commercial tests of public preferences for radio sets have been made by arranging three or four competing sets behind screens on a stage in front of the audience. These sets then are played in succession and the audience is asked to vote on which set they prefer. Presumably none of the voters know which set is playing. Judgments are supposed to be based solely on the quality of music or other program material reproduced.

From the viewpoint of psychological technique, a number of objections might be made to this over-simple test method, but only one of these possible objections concerns us here. This is the chance that the order in which the four sets are played may influence the audience's judgment, regardless of actual differences in quality. If it does, conductors of such tests need merely to place their own set in the third or other favored position, count the votes and automatically rate their own product as the winner.

To get some actual information on this point, such a test was carried out before ten groups of university students, nearly

[By E. E. Free, Ph.D.]

all of whom were men and most of whom were university freshmen, graduates of recognized high schools or similar institutions and largely residents of New York City or its neighborhood. So-called intelligence tests given to these same students at other times, as well as a considerable amount of other psychological test information, indicates that these students agree reasonably well with the upper third of the American population in intelligence and general culture. They undoubtedly represent a somewhat more intelligent and cultured group than the average of the American radio audience. Probably they are reasonably representative of prospective buyers of higher-priced radio outfits.

The Stage Sitting

In staging the tests, four different radio sets were arranged side by side on a platform in front of the students, seated as usual in the science classroom. This array of sets was shown to the students beforehand, but during the tests themselves all were hidden by a thin cloth screen similar to a motion-picture sound screen. The sets were controlled, however, by four large and easily visible switches in full view of the students and numbered 1, 2, 3 and 4. As each of these switches was closed, in turn, by the instructor conducting the test, the corresponding music was heard from the invisible reproducers behind the screen.

Every precaution that we could think of was taken to have all four playings conducted in exactly the same fashion. Preliminary tests showed that no one could determine by watching the loudspeakers, by judgment of sound direction or in any other way, which receivers were operated by the different switches. To avoid probable differences in the quality of actual radio programs at different times, a phonograph record was substituted, a high-quality electric pick-up working into the audio-frequency amplifiers and loudspeakers of the four radio outfits. For each of the four playings, exactly the same portion of this phonograph record was used, a time of precisely thirty seconds being allowed in each case, as determined by a stopwatch. New phonograph records and new needles were used, to avoid possibility of deterioration in quality. The speed of the phonograph was carefully checked and the loudness level of the music in the room was kept the same and was measured during each test by a noise meter connected to a microphone placed among the listeners.

The preliminary talk, describing the test, was given in each instance by one individual (myself) in order to avoid any chance of varying verbal suggestions to the different groups of students. This advance talk asked the students to consider nothing but their personal preferences for one of the four sets tested. They were asked not to try to judge on the basis of scientific musical quality but merely to set down the one of the four reproductions the quality of which they personally preferred.

The suggestion definitely was given that they might not be able to distinguish the four sets, because of bad ears, poor musical judgment or something of that kind. If so, they were to say that they could distinguish no difference. They were told that the purpose of the test was to dis-

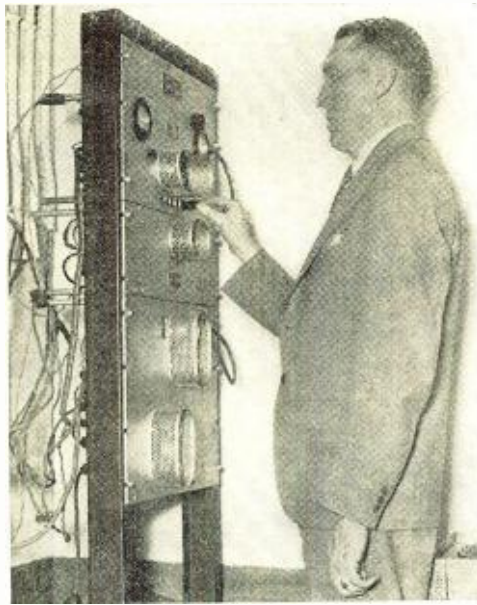

THE AMPLIFIER USED
This is the amplifier panel through which all of the records were played during the four tests

cover to just what extent they, the students, would agree with the general public in radio set preferences.

This talk was given in advance of the four playings. These playings then followed, lasting exactly 30 seconds each with intervals of about 5 seconds between them. The four numbered switches, 1, 2, 3 and 4, were closed, visibly and ostentatiously, for each playing. So far as we could determine, only one voter out of the total of 423 had even the slightest doubt that four separate and distinct radio receivers were played, one after the other; this single doubter being already well known to us as a chronic skeptic, with cause or without.

In fact, this whole drama was an elaborate fake. No different receivers were played. What actually happened was that each of the four switches controlled and operated the same amplifier working the four loudspeakers simultaneously. The four playings, so far as was humanly possible, were absolutely identical with each other. The combined quality in all instances was about that of an average good-quality radio

receiver, having some deficiency in the extreme high frequencies and extreme low frequencies, but without any serious errors or defects.

What actually was tested was not any preference of the students for different qualities of radio or phonograph music, since there were no such differences in quality. The thing really tested was the preference of the students for first, second, third or fourth place in a list of four playings, all of which were absolutely identical.

The Results

Four hundred and twenty-three students were tested. Of these, 138 or 32 percent recorded a preference for what they thought was set number 2, really the second time that the uniform music was played; 115 students or 27 percent voted for playing number 1; 80 students or 19 percent preferred number 3; 62 students or 15 percent preferred number 4.

Only 28 students or 7 percent recorded on their voting slips that the playings all sounded alike, that they had no preference, or some equivalent remark. The first conclusion, and in many ways the most interesting one, is, therefore, that 93 percent of 423 university students believed themselves able to distinguish a difference in quality between four samples of musical reproduction when, in fact, no such difference existed.

It is evident that our results give no support to the theory that third place in a list of four usually is preferred. Instead, the maximum preference in our list is for second place, although we are not sure that the lead of second place over first place is large enough to be significant.

It does seem to be significant that first and second place, taken together, have so large a lead over third and fourth places, totaling 59 percent of the total votes as against only 34 percent for the combined third and fourth. This clear preference for the earlier playings may be related to increasing fatigue of ears or of attention as the repetitions of the same music continued. Our data provide no way of testing this.

Comparing the vote scores of individual
(Cont'd on page 161)

PRELIMINARY TALK BEFORE EACH TEST

The four sets were first placed in view with the sound screen rolled up and a description of the tests were given in each instance by the author in order to avoid any chance of varying verbal suggestions to the different groups of students

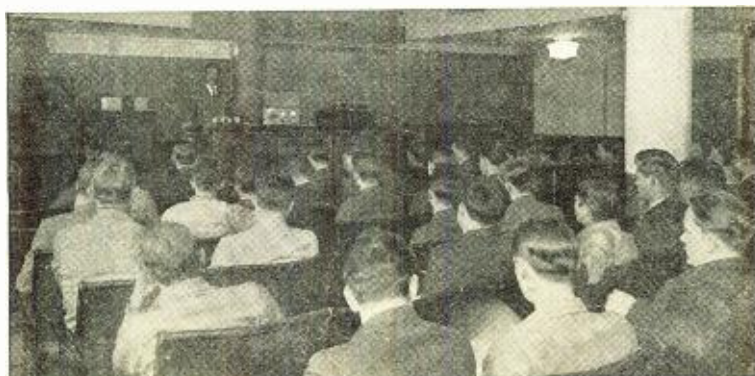

Getting the Most Out of the SHORT WAVES

For many the short waves have given thrills that are not to be forgotten. There are some, however, to whom the short waves have been a disappointment and among these the greater number have failed because they started out with the wrong equipment and with erroneous ideas of short-wave phenomena. A well-known figure in short-wave listening circles gives a few pertinent suggestions

ALTHOUGH short-wave radio has made great strides recently, there is still much to be learned about it. Today, there is one group of radio men who are telling the world not to expect much from short waves while another group is telling all about the wonders of reception to be had on a short-wave receiver. Between the two groups, Mr. and Mrs. John Public hardly know what to believe. These two groups are made up of people whose experiences with short-wave reception has been either good or bad, according to which group they are in. The writer has been a short-wave experimenter since 1926 and has come in contact with many well-known short-wave broadcast experimenters, both in the United States and abroad. He has corresponded with people in all the different stages of short-wave work. This experience has given an insight on the troubles that are met by most short-wave fans who complain that they are unable to get results. No attempt will be made in this article to tell what may be expected from a short-wave receiver, but how to go about getting the most out of short waves will be considered.

The degree of success obtained by a listener on short waves depends on four things; namely, the receiver used, the accessories, the location and the skill of the operator. By accessories we mean such things as the antenna and ground system and the quality of the tubes used. These things are far more important on short waves than on long waves and they must be given good attention.

Taking these things in order, we first come to the receiver. Here we find a consideration that has given short waves more "black eyes" than any other thing. If you are accustomed to hearing local broadcast stations on an eight or ten-tube receiver that has enough volume to fill your home with good music and entertainment, you will hardly be satisfied to go back to the old-style one and two-tube receivers, would you? The volume, clarity and tone would be missing. A few years back, there was nothing but one and two-tube sets for the short-wave listener, and people who bought them usually were not satisfied. But today things are different, since the modern short-wave set is the equal of a long-wave receiver. There are still a number of small sets sold, and they have their place in the

short-wave field. But no one can expect a one or two-tube set to bring in stations ten thousand miles away with the volume and clarity equal to a ten-tube broadcast set, just because it happens to be a short-wave receiver. But thousands of people have bought or built these little sets and expect such results. True enough, it is possible to get many distant stations on a small set, and oftentimes a small set in the hands of a skilled operator will perform better than a large set in the hands of an unskilled operator, when it comes to getting the most stations. But certainly no little set can equal a modern high-powered, multi-tube receiver for quality of tone, volume and consistency. If you like to experiment and listen with headphones for distant stations, the small set may be satisfactory, of course, but if you do buy one, remember that you can only expect lesser results. And if you are not satisfied, don't blame it on the short waves. A Rolls-Royce engine does not come in a "flivver."

[By Arthur J. Green*]

Another thing to remember when buying a short-wave receiver is that some of the multi-tube sets are manufactured on a production basis. Some sets do not cover the short-wave field completely, yet they are advertised as "all-wave" sets. Some, we have seen, go down to only about 150 meters and others down to only 75 meters. No real distant broadcasting stations are heard above 75 meters. International broadcasting takes place below that wavelength. On such receivers, only police stations, aircraft, beacons, code and amateurs are heard. In other words, some of these sets are just half short-wave sets. If the receiver you have in mind does not go down to at least 15 meters, you are going to miss a lot of the pleasure of owning a short-wave or all-wave receiver as the case may be.

Adapters and converters are confusing to nearly all newcomers in short waves. There is a world of difference between them. An adapter simply uses the detector tube of the receiver and the audio stages, picking up the signal like a regenerative receiver and sending it through the audio stages. Since the modern radio receiver goes in for more radio-frequency amplification and less audio amplification, the signal from the adapter is usually too weak to be heard well, simply because there is not enough radio-frequency amplification to build the signal up to loud-speaker strength. A converter is a different

A FAMOUS ITALIAN TRANSMITTER

Station I2RO at Rome is one of the best known short-wave stations in the world. For one who likes opera, this station should prove a boon with its strong transmissions

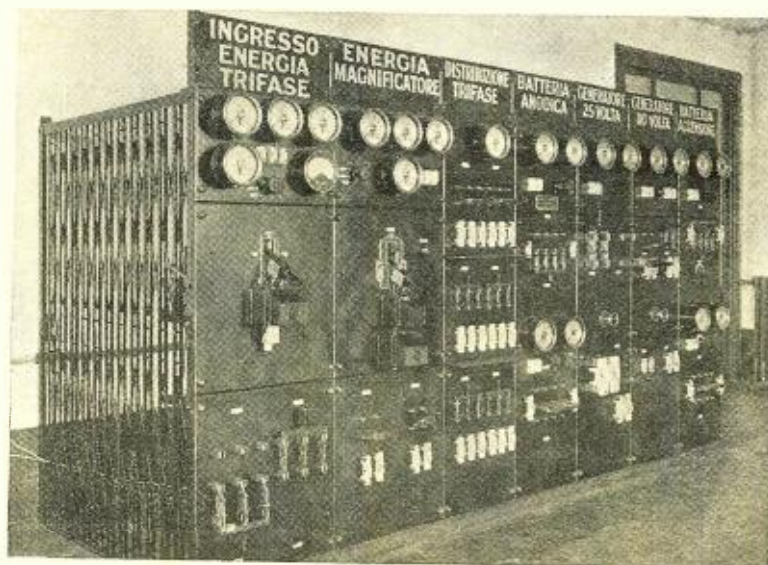

*President, International Short-Wave Club.

proposition. It takes the signal as it comes from the antenna and changes it into electrical impulse of constant frequency which is sent through all the tubes in the receiver. The way to tell the difference between an adapter and a converter is to find whether you have to take the detector tube out of your receiver to install it. The converter works with the regular receiver, on the antenna and ground and using the set's r.f. amplifier, while the adapter takes the detector tube out of the regular receiver and uses it to detect the signal in the adapter.

When a set is installed, all tubes should be thoroughly tested. We say this because oftentimes a tube will work well enough on powerful signals, but may not be able to amplify or detect a weak one. Have every tube tested, no matter if they are new! The detector tube in a short-wave set is very important. Change the tubes about in the set till you find one that works best in the detector socket. Do this by tuning in a fair signal and note the volume as each different tube is inserted. If the set has a tendency to howl, tap the detector tube with your finger and see if it sets up a bell-like howl. If so, replace it.

Antenna Considerations

Now for the antenna. Many aerials that work well on long waves are not suitable for the short waves. The average radio receiver today has enough radio-frequency amplification to pick up signals on a short piece of wire used as an antenna. But the actual amount of energy picked up from a station ten thousand miles away is only a fraction of that picked up from a local station, and every bit of it must be conserved and passed on to the receiver if the station is to be heard satisfactorily. An aerial used for short-wave reception must be well insulated, free from moving objects, and the lead-in wire, especially, must be stout and well insulated. Don't be afraid to use insulators and many of them. The lead-in should not run all over the house or the room before it reaches the receiver. Run it to the window nearest the set and then as direct as possible to the set.

Noises. Here is where we sometimes get into deep water. Although short waves are not so susceptible to common static, they are more susceptible to the man-made variety of noises. In some places the interference caused by elevators, refrigerators, electric fans and loose light sockets may be so small that they will hardly be noticed on long waves, but on short waves they may entirely ruin reception. Such conditions are not extremely common, however, and if you have a good location for long-wave reception you may expect the same from short waves. The answer to the noise problem on short waves is the transposed lead-in antenna. Science has proven that most man-made static on short waves is picked up by the lead-in. To kill the noise picked up by the lead-in, a second wire is run down along the side of it, crossing it every so often by means of transposition blocks; this second wire is used in place of a ground on the input of the receiver. A complete story on noise-reducing antennas appeared



HAVE YOU HEARD HIM SPEAK?

This is Edward Startz, a short-wave announcer at PCJ and now directing programs at PHI at Huizen, Holland. He speaks seven different languages with equal facility and his English is a pleasure to listen to

receiver. If the first turns of the dial do not bring forth signals from a number of stations, or if the first few stations tuned in do not include a distant one, they assume that the set is no good or short-wave reception is all "bunk."

Short-wave tuning is different from broadcast tuning. On the long waves we know almost when and where (on the dials) to find stations, for we grow accustomed to tuning them in day after day. But on a short-wave set we must search for the stations at first and then keep a record of the dial-reading in order to go back and get it later. It is not necessary to keep a written record always, as dial settings on a short-wave set soon get fixed in the mind just the same as on long waves. But you must search for the station at first, and to get it you must tune *when it is on the air!*

Short-wave stations usually tune very sharply. That is, they do not take up much space on the dial. In running up and down the dials you might pass over a distant station dozens of times and never know it is a station unless you happen to stop right on the exact spot where the signal is located. Therefore, you must tune slowly.

The best way for a beginner to proceed is: First spend a few days tuning in local stations, marking down the wavelengths and dial settings, and at the same time learning how to operate the dials and controls on the set. After a number of local stations have been logged, look in an up-to-date station list to learn just what stations are near the same wavelengths as the stations already logged. (Note—Short-wave stations are mostly experimental and change quite often. Be sure your station list is up to date and kept up to date or you will spend

much time tuning for stations that are not on the air.) Then, paying particular attention to the time each station is on the air, tune for it near where the local station was heard on the dial. For example, you can easily tune in W2XAF, New York, on 31.48 meters and station VK3ME is just a shade on the dials above it.

Most short-wave stations broadcast in the evening of their own local time. That is why you hear Australia in the morning in New York. Melbourne is fifteen hours ahead of New York time. Berlin is six hours ahead and Honolulu, Hawaii, is 5½ hours later than New York time.

Most short-wave stations are experimental and change wavelengths or
(Continued on page 186)

THE VENEZUELAN STATE BAND

Citizens of Venezuela are proud of this organization and they tell the world so by broadcasting their music over the short waves. The band plays in the city park in Maracaibo and is usually broadcast over station YF11BMO



Home-made Relays for the Pickle Bottle Photo-cell

In previous issues Mr. Wendel gave instructions for making and using a simple photo-electric cell. This month he shows how to make two types of relays to work with this cell

By M. L. Wendel
Part Three

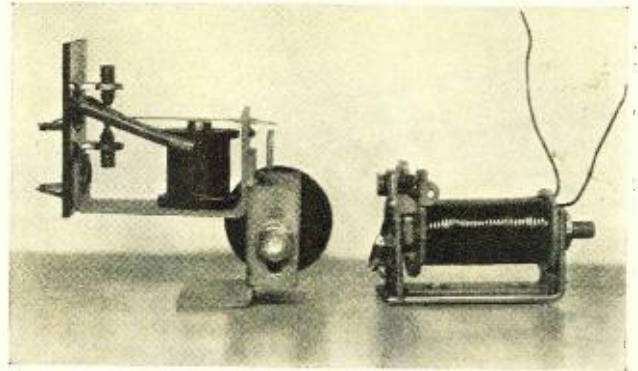

THE FINISHED RELAYS

At the left is the highly sensitive relay which is operated directly by the cell, without resorting to the use of an amplifier. The power relay at the right is actuated by the sensitive relay and is used where relatively heavy current is to be controlled. Complete constructional details for both relays are shown in Figures 1 and 2

ONE thing that has worked to prevent the home experimenter from enjoying the fascination of photo-cell investigation has been the cost of sensitive relays that will respond to the minute currents generated by this type of cell. Naturally it is easy to close a comparatively insensitive relay if a sufficient powerful vacuum tube amplifier is placed between the relay and the cell, but in this case we wish to entirely dispense with this equipment so that the operation will be more positive and less expensive at the same time.

The bobbin is wound full of No. 32 single silk-covered magnet wire and then the winding is covered either with greased paper or cellophane which will keep out moisture. Naturally the winding can be greatly facilitated by the use of a lathe or, lacking that, by a hand drill held in a vise.

Two contact screws are cut and slotted at the end with a hack-saw so that they can be adjusted with an ordinary small screw-driver. Tiny silver contacts are soldered to the opposite end of these screws. This done, it will be necessary to cut out the holders for these screws. After the holes are cut and tapped as shown at B, the screw members are split with the hack-saw as illustrated.

The armature (C) is cut from thin sheet iron and provided with a contact at one end—the small end. To put this contact in place, a hole is drilled through the iron and the contact permitted to project on either side, thereby forming what really amounts to two contact points.

The main body of the relay is made up of sheet brass and these members are bent as illustrated at D and E. A small bakelite or hard-rubber panel (F) is attached to the one member and this carries the two (Continued on page 186)

In Figure 1 and in the photograph we see a simple relay that may be made by any home experimenter with every assurance that it will work and at the same time come within the resources and mechanical equipment of his shop. First, and perhaps foremost, is the bobbin (A) which is made up of a soft iron core with two fibre washers forced over its ends. This will have to be done with some care to make these bobbin ends secure.

DETAILS OF THE SENSITIVE RELAY

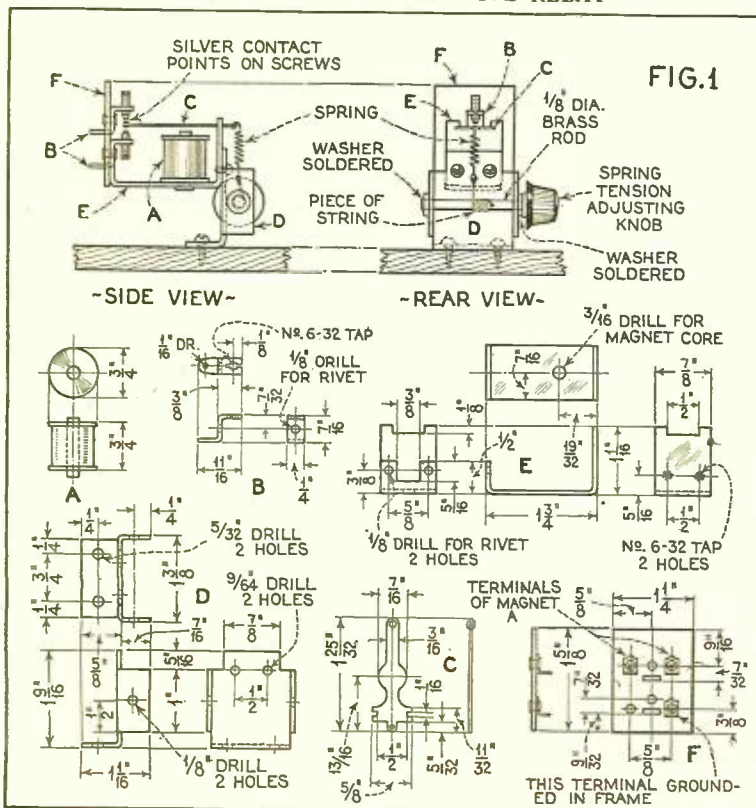

DETAILS OF THE POWER RELAY

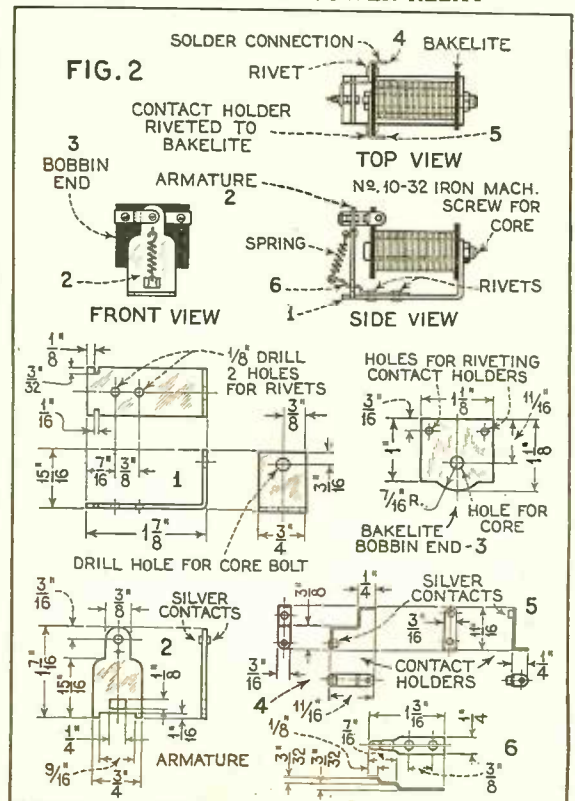

AN ANALYSIS OF LINEAR RECTIFICATION

By Frederic Siemens

IT is frequently necessary to analyze the output of linear rectifiers in order to determine the amount of filtering required or to estimate the degree of distortion likely to occur under optimum conditions. Thus if a ripple neutralizing circuit is to be used to effect filter economies, it is necessary to know the approximate magnitude of the disturbing component in the rectifier output before the circuit is designed. Such neutralizing circuits frequently take the form of a condenser and resistor in series, or a series-tuned circuit of proper resistance connected between a point at or near the rectifier output and some point in the radio receiver or amplifier. A linear rectifier is frequently used to indicate percentage modulation of oscillators or transmitters, by comparing the d.c. to the a.c. in the rectifier output. Linear rectifiers are now widely used as combination second detectors and source for automatic volume control in superheterodyne receivers. In this connection it is essential to know whether the d.c. component in the rectifier output is independent of the percentage modulation of the incoming signal or not. The following analysis will show that for a perfectly linear rectifier, the d.c. component depends only on the carrier amplitude and is independent of the percentage modulation.

Simplified Analysis

The usual analysis of rectification involves the solution of a Fourier series and the integration of certain trigonometric expressions to obtain the coefficients of the series. The same results can, in general, be obtained without resorting to integration at all by a multiplication of series and some obvious trigonometric transformations. Thus let it be required to find the expression for a simple harmonic wave, after rectification by a half-wave rectifier. Figure 1 illustrates the voltage current characteristics of the linear rectifier with slope K . Such a device offers a constant attenuation to the positive half-cycles and completely blocks the negative half-cycles. Thus a series of sinusoidal pulses at half-cycle intervals will appear in the output of the rectifier. This is equivalent to saying that the input wave is multiplied by a square wave such as that of Figure 2. The series representing such a wave may be found from any good handbook of mathematics or textbook on series and is that shown in Figure 2.

Multiplying the input wave by $F(\theta)$ gives:

$$\frac{KA}{2} \cos \theta + \frac{2KA}{\pi} \cos^2 \theta - \frac{2KA}{3\pi} \cos \theta \cos 3\theta + \frac{2KA}{5\pi} \cos \theta \cos 5\theta \quad (1)$$

From any good text on trigonometry we find:

$$\left. \begin{aligned} \cos^2 \theta &= \frac{1}{2} \cos 2\theta + \frac{1}{2} \\ \cos \theta \cos 3\theta &= \frac{1}{2} \cos 4\theta + \frac{1}{2} \cos 2\theta \\ \cos \theta \cos 5\theta &= \frac{1}{2} \cos 6\theta + \frac{1}{2} \cos 4\theta \end{aligned} \right\} \quad (2)$$

By substituting these values in (1) we have:

$$\frac{KA}{2} \cos \theta + \frac{KA}{\pi} \cos 2\theta + \frac{KA}{\pi} - \frac{KA}{3\pi} \cos 4\theta - \frac{KA}{3\pi} \cos 2\theta +$$

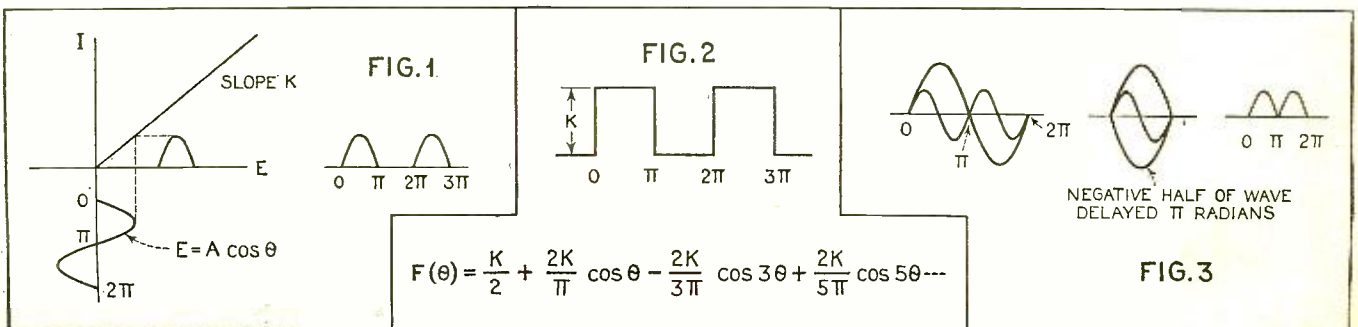

$$\frac{KA}{5\pi} \cos 6\theta + \frac{KA}{5\pi} \cos 4\theta$$

Obviously, from (2), if we are only interested in terms up to 40, $F(\theta)$ extending to 50 is all that need be used. Collecting, we have:

$$\frac{KA}{\pi} + \frac{KA}{2} \cos \theta + \frac{2KA}{3\pi} \cos 2\theta - \frac{2KA}{15\pi} \cos 4\theta + \dots (3)$$

which is the equation for the rectified wave shown in Figure 1.

This solution can, with the exercise of a little judgment, be extended to the solution of a full-wave rectifier. Now a full-wave rectifier will produce two identical rectified waves differing in phase by π radians (or 180 degrees). From Figure 3, it will be evident that under these conditions $\cos \theta$ will balance out, but the even harmonics will add directly, since they are in phase. Obviously, the d.c. or constant terms will also be additive. Therefore the expression for the output of a perfect full-wave rectifier with sine-wave input will be:

$$\frac{2KA}{\pi} + \frac{4KA}{3\pi} \cos 2\theta - \frac{4KA}{15\pi} \cos 4\theta + \dots (4)$$

This same simple device can obviously be used to solve for the output of a linear rectifier to which a modulated wave is applied. The expression for a modulated wave is usually taken as:

$$E = A \cos \theta (1 + M \cos \Phi) \quad (5)$$

where $\frac{\theta}{2\pi}$ is the carrier frequency, $\frac{\Phi}{2\pi}$ is the modulation frequency, and M the percentage modulation. If this wave is applied to a half-wave rectifier, we have:

$$E \times F(\theta) = \left[A \cos \theta + \frac{AM}{2} \cos(\theta + \Phi) + \frac{AM}{2} \cos(\theta - \Phi) \right] \left[\frac{K}{2} + \frac{2K}{\pi} \cos \theta - \frac{2K}{3\pi} \cos 3\theta + \frac{2K}{5\pi} \cos 5\theta \right] \quad (6)$$

This makes use of the trigonometric relation:

$$\cos \theta \cos \Phi = \frac{1}{2} \cos(\theta + \Phi) + \frac{1}{2} \cos(\theta - \Phi)$$

Expanding (6), we have:

$$\begin{aligned} E \times F(\theta) &= \frac{KA}{2} \cos \theta + \frac{MAK}{4} \cos(\theta + \Phi) + \frac{MAK}{4} \cos(\theta - \Phi) \\ &+ \frac{2KA}{\pi} \cos^2 \theta + \frac{MAK}{\pi} \cos \theta \cos(\theta + \Phi) + \frac{MAK}{\pi} \cos \theta \cos(\theta - \Phi) \\ &- \frac{2KA}{3\pi} \cos \theta \cos 3\theta - \frac{MAK}{3\pi} \cos(\theta + \Phi) \cos 3\theta \\ &- \frac{MAK}{3\pi} \cos(\theta - \Phi) \cos 3\theta - \frac{2KA}{5\pi} \cos \theta \cos 5\theta + \frac{MAK}{5\pi} \cos(\theta + \Phi) \cos 5\theta \\ &+ \frac{MAK}{5\pi} \cos(\theta - \Phi) \cos 5\theta \dots = \end{aligned}$$

(Continued on page 187)



A Three Stage High-Quality **PUSH-PULL AMPLIFIER**

IT has been no secret to sound engineers that flat-line amplifiers can be built covering a frequency range from 20 to 20,000 cycles.

However, until quite recently there has been no incentive to educate the critical listening public to the need for such exceptional units, because microphones and loudspeakers were not available to reproduce a band of frequencies covering about nine octaves of the audio spectrum. Moreover, standard methods of transmission, over wire, further restricted the reproduction of such a wide band of frequencies.

It is only within the past year that major improvements in sound pick-up and transmission have been made. Remarkable improvements in extending the frequency range of microphones, reproducers, and transmission lines now really make possible the reproduction of speech and music over a wide range. With such a wide frequency spectrum available, the entire gamut of orchestral effects, from the snare drum to the oboe, can be reproduced fully in true perspective and with all the overtones of each instrument in the orchestra.

It is not without significance that the Bell Laboratories and such an outstanding musician as Dr. Stokowski are co-operating to exploit the possibilities of reproducing speech and music with lifelike realism at great distances from the original source of sound. Apparently both our wired and radio transmitters are progressing far beyond our present commercial audio amplifiers.

Without doubt, transmission and public-address engineers are interested in the "quality" phase of sound reproduction. Flat-line amplifiers in this field are particularly welcome and necessary. They are also required for the reproduction of sound effects from the new wide-range sound film recordings and the long-playing, vertically cut, hill-and-dale records which are coming into wide use. Sound engineers in this phase of the art require

By
S. L. Baraf
and
I. A. Mitchell

amplifiers which are flat from 30 to 15,000 cycles.

High-quality amplifiers for applications such as the above have been rarely described. There are four distinct requisite features which a "quality" amplifier must possess:

1. Uniform frequency response
2. High gain
3. Low harmonic distortion and phase shift
4. Minimum hum level.

In a well-designed audio amplifier, practically all frequency discrimination lies in the audio transformers, so a proper choice of these units takes care of the first requirement. An overall frequency run on the amplifier described here shows a variation of less than 2 db. from 30 to 17,000 cycles.

High gain is effected in this new amplifier through the use of three stages. An approximate overall gain of 97 db. is obtained. The first stage uses type -57 tubes in push-pull, which are coupled to push-pull type -56 tubes in the second stage through a Kenyon screen-grid coupling unit. The high efficiency of this unit provides the unusual gain available, without frequency discrimination in the input stage.

The second stage is transformer-coupled to the push-pull type 2A3 grids. It is well to note the peculiarities of the type 2A3 tube. The standard method of operating 2A3 tubes, with 300 volts on the plate and 60 volts bias, is a highly overbiased condition. If accurate measurements are made, it is found

that a variation in signal voltage, from zero to the maximum Class A value, will produce a variation in plate current from 40 to 80 ma. per tube. While the tube has been designed with a low a.c. plate resistance, this plate current variation introduces an appreciable amount of harmonics.

In a self-bias circuit, the bias voltage is created by the plate current flowing through a resistor between cathode and ground. It is evident that the plate current variation will cause a

FREQUENCY CHARACTERISTIC

The response is substantially flat, within 2 db., from 20 to 17,000 cycles

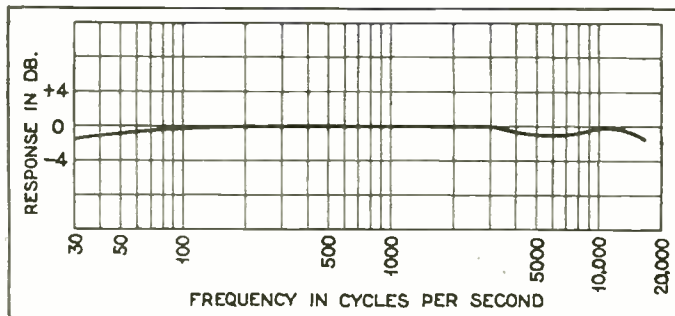

fluctuating bias voltage and so set up another source of harmonics. Using self-bias, it is found that 10 watts output power is obtainable and the harmonic content is 5%.

Fixed-bias operation requires an absolutely constant plate and bias voltage. The plate supply can readily be taken care of through the use of a power transformer and a filter system having good regulation. The real difficulty lies in the method of obtaining bias. While a voltage-divider system is the first thought, it was found that this will not be constant. The portion of the divider in the grid circuit must still carry the 2A3 plate current, and since this is variable, the bias voltage would fluctuate.

An ingenious system of bias supply has been incorporated in this amplifier which does not require a separate transformer for the bias system. An unused 2½-volt filament winding on the power transformer is employed to supply current to a type -82 tube filament, and the center tap of this winding is connected to one side of the high-voltage winding. The resultant circuit is that of a half-wave rectifier system rectifying in opposite direction to the normal power supply. In other words, the output voltage of this rectifier is entirely below ground. All but 60 volts of this output is lost in the LCR filter circuit, leaving the proper voltage for bias use. As negligible grid current is drawn by the output stage, very little current is required in the bias system, only 5 ma. being used in the circuit shown.

It is important to remember that the filtered C-bias supply is 60 volts negative with respect to ground and that the filter condensers are consequently connected with positive side to ground.

Using fixed bias, an easy 15-watt output is obtainable with a harmonic content of only 2.5%.

While a certain percentage of harmonics come from the tube circuits, it is important that the transformers used have low phase shift and that the core material be operated at proper flux densities. The even harmonics are balanced out in all stages, due to the push-pull tube arrangement.

Hum level can generally be charged to the filament supply,

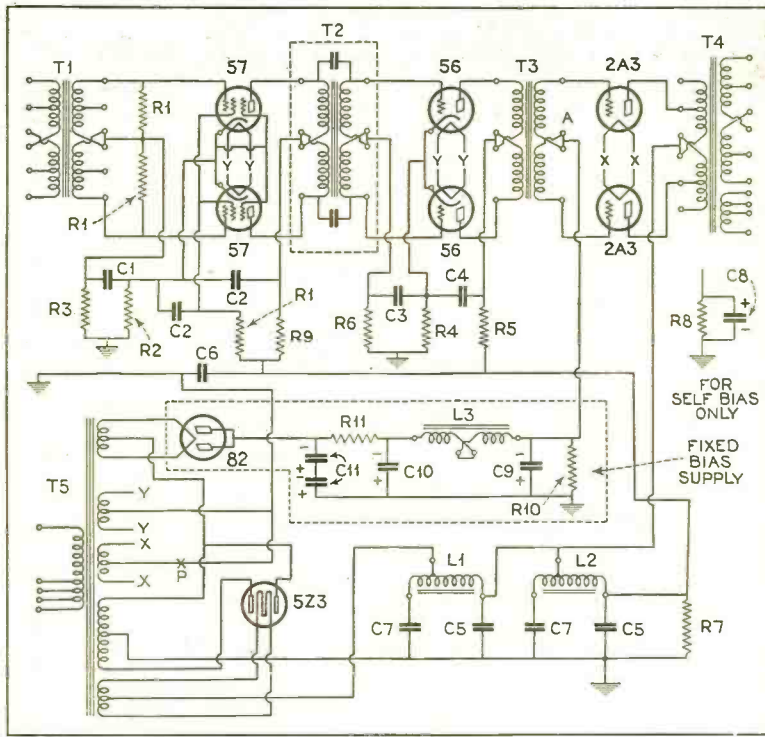

THE CIRCUIT DIAGRAM

The hook-up of the fixed bias amplifier is shown above. Readers who wish to employ self-bias should make the following changes: Eliminate fixed bias supply; insert bias resistor and condenser (R8, C8) in center tap of filament winding (XX). Connect the point A to ground

plate supply, inductive pick-up, and electrostatic pick-up. Heater type tubes in the first stages keep the filament supply effect very low. The plate supply circuit is well filtered, using tapped filter reactors. The trap circuit obtained by the first condenser and short section of the choke is extremely effective, and yet the value 1 mfd. is not at all critical. A reduction of 78% in hum level was effected through the use of the trap circuit as compared with a brute-force filter. For the sake of uniform layout, 500-volt condensers were used, even on the bias filters.

All stages are connected in push-pull, which has the effect of balancing out both filament and plate ripple. It is essential that the audio and power components be in substantial shielded containers in an amplifier having such high gain. All units used were housed

in thick cases of high-permeability cast iron. Keeping grid and plate leads short and far from the filament and B supply leads effects a minimum of electrostatic pick-up. This is augmented by the internal electrostatic shielding of the transformers. Due to the above conditions, the hum level is entirely inaudible.

The input and output impedances available are highly universal. The Kenyon KL2G input transformer has a split-tapped primary for connection to incoming lines from dynamic or velocity microphones, high or low-level pick-ups and other pick-up apparatus. The available input impedances are 17, 50, 125, 200, 333 and 500 ohms. Each half of the secondary is shunted with a ¼-megohm resistor to maintain uniform response and proper reflected impedance on the input circuit. The output transformer is even more universal in application. The primary is tapped for use with fixed bias (3000 ohms) or self-bias (5000 ohms). One output winding has available impedances of 50, 125, 200, 250, 333 and 500 ohms, for telephone lines. Another winding will match up to ten voice coils, through an impedance combination of 1.3, 3, 4.5, 7.5 and 15 ohms. A unique method of transformer structure maintains a uniform frequency discrimination (Cont'd on page 180)

THE AMPLIFIER



THE POWER SUPPLY



How to Build Your Own Shielded Lead-in System

The constructional details given here make it a simple matter to build and install a highly effective, interference-eliminating antenna system—at an extremely moderate cost

By H. J. Adler

THE purpose of this article is to discuss ways of eliminating so-called man-made static, such as disturbances set up by motors, violet-ray machines, X-ray machines, electrical household equipment, etc. Up to the present time attempts have always been made to eliminate the disturbance at its source by means of shielding and expensive filters. But now manufacturers are beginning to realize that it would be easier, and an aid to sales, to introduce some device at the receiver itself to perform the above function.

There are three ways in which this type of static can enter the receiver. They are:

1. Antenna and lead-in system of the radio receiving set.
2. Wiring, tubes, and any unshielded portion of the receiver.
3. Source of power (a.c. or d.c. line).

Each of the above will be treated separately in this article.

Elimination of Disturbing Signals in Antenna and Lead-in System

If the lead-in could in some way be kept from picking up any signals regardless of its length, the antenna could be placed out of the field of any local disturbances, thereby preventing it from receiving any of those noises that we are trying to eliminate. One method of doing this is to connect the antenna and receiver with a shielded low-impedance line. This requires a step-down transformer at the aerial and a step-up transformer at the set. In experiments carried on by the writer, that and a few other similar methods were tried, but were dropped due to the high cost of the shielded wire and to the fact that if any great length of lead-in was used, the shield had to be grounded in two or more places. The method finally accepted is shown in Figure 1. Two insulated wires are twisted together and used for the lead-in. At the antenna end of this line one of the wires is cut about

six inches short and the other is fastened to the aerial. The receiver end connects to two similar primaries in series. The secondary feeds into the receiver in the customary manner. The theory is that one lead carries signal plus the disturbing noise, while the other carries only noise; the noise cancels out in the primary circuit, leaving only the desired signal. In Figure 1, L1 and L2 are the primaries, L3 the secondary, and S is an electrostatic shield to prevent any capacity coupling between the primaries and the secondary. C1 and C2 are a fixed and a trimmer condenser respectively; their purpose will be explained later.

The method of measuring the attenuation of lead-in pick-up is as follows: A dummy lead-in about fifty feet long is fastened to the coils the same as in Figure 1, but a single-pole, single-throw, anti-capacity switch is connected in at the point SW. The wires at the far end of the line are connected together and to the high side of a signal generator. The other side of the generator is returned to ground. A receiver is put on the output of the eliminator. The amount of attenuation of undesired signal is the ratio of the sensitivity of the receiver with SW open and the sensitivity with SW closed.

Transformer Design

A few coils were wound with various values for L1, L2 and L3. They were tried in the above set-up, and the results showed that as long as the two primaries were symmetrical to each other and in their relation to the secondary, the attenuation of lead-in pick-up would be the same regardless of the values of inductances used. The size of the coils could therefore be chosen so as to give a minimum of attenuation to the desired signal from the antenna itself. A mathematical analysis, which is too lengthy to give here, showed that the relation between the primaries, secondary and mutual inductances for optimum results was

The Proof of the Pudding

THE interference-eliminating system described in this article was put through exhaustive tests in the Engineering Laboratory of one of the largest receiver manufacturers in the world. Their report shows that noise picked up by the lead-in is reduced 55 decibels, while signals picked up by the antenna are attenuated a maximum of 9.5 db. (at 1500 kc.) and at 550 kc. are attenuated only 5.0 db. In these tests the receiver was a standard model having an overall gain of 114.0 db. Thus in locations where pickup of noise by the lead-in is bad the improvement in the signal to noise ratio resulting from the installation of the antenna system and line filter described here is tremendous.

—THE EDITORS.

THE SCHEMATIC CIRCUIT DIAGRAM

Figure 1. The initial adjustment of C2 when the installation is made is the only one necessary. Note that only one transformer is required and that one is located near the receiver. The transformer and condensers must be thoroughly shielded to prevent direct pickup of noise by the transformer itself

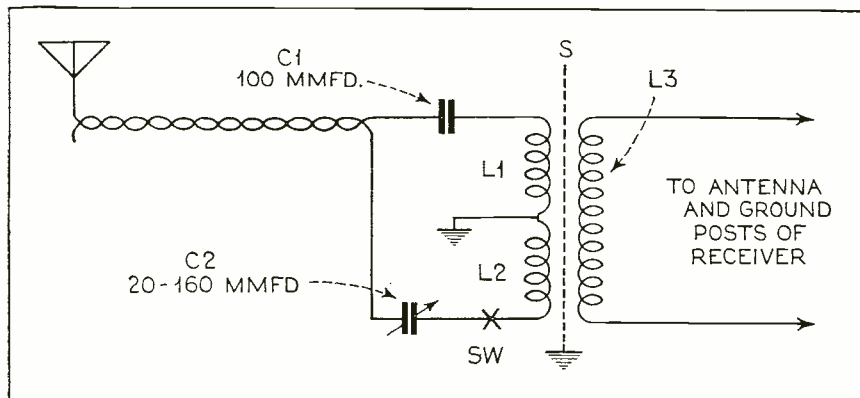

such that, in order to make a practical coil, the primaries would have to be of a low impedance and the secondary of a high. For the average receiver the values were:
 L1—100 micro-H
 L2—100 micro-H
 L3—3000 micro-H
 K—about 65%

The coil is shown in Figure 2, and the winding data of the coil used is as follows: The winding form can be either a cardboard tube or wood cylinder 1½ inch long and ¾ inch in diameter. The secondary is wound on first and consists of 450 turns of No. 33 enamelled wire. The winding length of this coil is 1 inch and it is insulated between layers with about .001 inch paper. Over the secondary is placed a winding of insulating paper .003 inch thick. The electrostatic shield is placed on next. This consists of a strip of tinfoil 1½ inches wide and just long enough so that the two ends will lack meeting by about a sixteenth of an inch. *This shield should not be a closed circuit.* Over the shield is placed more insulation .003 inch thick. The two primaries are now wound on. They consist of 75 turns each of No. 33 enamelled wire. The two windings must be identical and equidistant from the center of the form, and, as the winding will run slightly over one layer, the only way to do this is to start the winding of each primary from the center and work outwards. The secondary leads are brought out from one side of the coil, and the primary and shield leads from the other.

L1, when tuned by the antenna capacity, resonates within the broadcast band, making it necessary to place C1, a 100 mmfd. condenser, in series with it. C2 is put in the other lead to make both circuits symmetrical. With the above values and on an average antenna, L1 and L2 will resonate at about 1800 kc. The adjustment of C2 is not dependent upon the length of the lead-in nor on the capacity of the antenna, making it possible for the manufacturer to adjust it before the device leaves the factory.

Shielding Important

It is important to keep the primary leads well shielded from the secondary leads, because if there is any capacity coupling between the two windings, the adjustment of C2 for maximum cancellation will vary as the receiver is tuned from one end of the band to the other.

Probably the best way to adjust the device when no signal generator is available is to run the double lead-in to within a few feet of the antenna but not connected to it. The receiver is then tuned to a weak station and C2 adjusted so the signal is at a minimum. The lead-in is then connected to the antenna.

Chassis Pick-up

Unshielded portions of the receiver, the variable condenser and the grid leads will pick up nearly as much noise as the lead-in itself. The most effective way to prevent this is to construct a steel

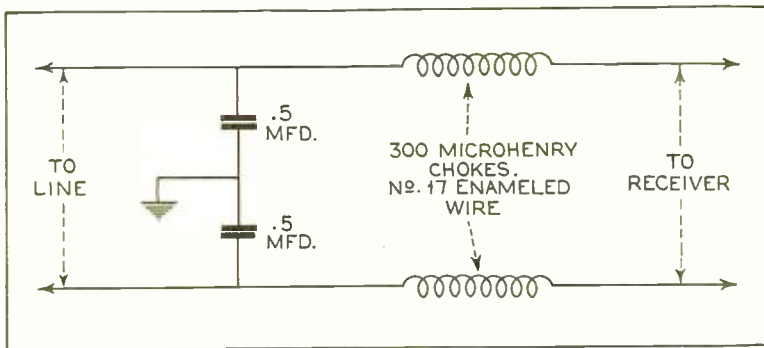

AN EFFECTIVE LINE FILTER

Figure 3. This filter is simple to construct. It should be shielded completely by inclosing it in an iron box

box to line the inside of the cabinet and enclose the entire chassis, with openings left, of course, for the dial and for ventilation. With this shielding it was found possible to place the set in the field of a strong r.f. signal without receiving any of it.

Eliminating Interference from Line

A line filter designed for this purpose is shown in Figure 3. The two coils are wound in the same direction and placed side by side

inductive relation to each other. The entire unit is mounted in a small metal can. This filter will in some cases work better without a ground, depending on the type of interference; but an increase in hum will result in most cases when the ground is eliminated.

Conclusion

On a completely shielded receiver with all the above devices it was possible to eliminate nearly all interference. Under actual measurement, the attenuation of lead-in pick-up was 65 db. and the attenuation of antenna signal varied only between 5 db. and 10 db.

Various noise-producing machines were turned on in the vicinity of the receiver, to see if they caused any interference. A one-half-inch spark coil could not be heard when run more than a few inches away. An a.c.-operated violet-ray machine caused no interference when placed a foot away from the set. Vacuum cleaners, electric motors and elevators caused absolutely no interference. All of which leads to the conclusion that if the antenna is carefully placed outside of the range of any local interference, and the methods described above are carefully followed, it will be possible to eliminate practically all man-made static and to enjoy the programs of distant stations without the inconvenience of turning off all the electrical devices in the vicinity of the receiver.

By way of explanation it may be well to add here that the antenna system described (or any other special lead-in system) will prove beneficial only where the field of interference embraces the lead-in but not the antenna—or where the antenna is in a relatively weak field of interference as compared with that in which the lead-in is located. Obviously if a source of interference is general and covers an entire neighborhood so that no matter where the antenna proper is placed it will be within the field of interference, no amount of attention to

CONSTRUCTIONAL DETAILS OF TRANSFORMER

Figure 2. Complete constructional data is given here to permit the reader to wind his own antenna impedance matching transformer

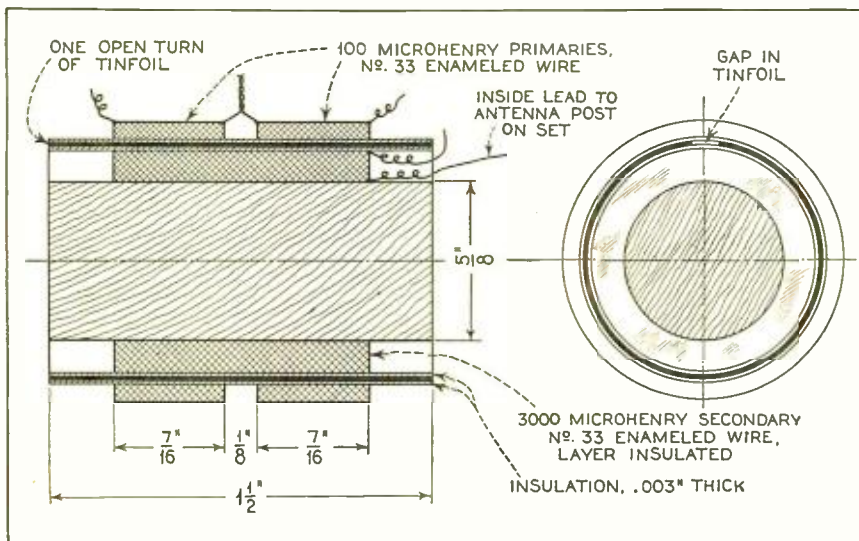

the lead-in will eliminate the trouble. But, on the other hand, a system such as that described here will oftentimes greatly reduce noise even though the noise is found over a large area, because in many cases such noise may be carried along and radiated from light or power wires. If the antenna is placed a fair distance from such interference carrying wires, then its pick-up of the interference will naturally be less. If the lead-in system is one which can-
 (Continued on page 185)

Practical Pointers on Utilizing METER RECTIFIERS

This comprehensive discussion on the characteristics of meter rectifiers, and methods employed by one instrument manufacturer in overcoming some of their complications, should be helpful to everyone who has occasion to use meters

THOSE technicians who have purchased instrument rectifiers to permit utilization of d.c. meters for a.c. measurements have probably observed some unexpected characteristics of such arrangements. For example, after connecting the rectifier to the 100-volt range of a d.c. voltmeter of the 1,000-ohms-per-volt type, it may be found necessary to apply an a.c. potential of about 117 volts in order to obtain a full-scale meter needle deflection of 100 volts. Furthermore, it may be found that one-half of the 117-volt potential will not produce a half-scale deflection of the meter needle. These characteristics may puzzle the technician until he makes a thorough study of instrument rectifier characteristics.

It is proposed to study the usual instrument rectifier characteristics in this discussion, and to show how they are applied to the design of the new Supreme Model 333 radio analyzer and point-to-point tester so that a single meter may be calibrated as (1) a multi-range d.c. milliammeter, (2) a multi-range ohmmeter, (3) a multi-range d.c. voltmeter, (4) a multi-range a.c. voltmeter and direct-reading capacity meter; by connecting the two terminals of the meter to the contact "arms" of a 2-gang 4-position rotary switch so that the meter may be selectively shifted to any one of the four measuring functions just named.

The d.c. meter which is utilized has a full-scale sensitivity of one milliampere (0.001 a.) adjusted for an effective internal resistance value of 300 ohms. The meter with the adjustment resistance is shown in Figure 1.

A "ring type" divided shunt is employed for providing six d.c. current-measuring ranges, as indicated by Figure 2, in which the shunt values total 75 ohms. The effective resistance for any current range is found by calculating the combined resistance of the shunt value for that range, the remaining resistance in series with the meter, and the meter resistance.

The multi-range ohmmeter circuits are indicated in Figure 3. A combination of a variable shunt, and fixed shunt and multiplier resistors are used so as to provide four resistance-measuring ranges without the use of switches. The resistor values are calculated on the basis of an internal ohmmeter resistance of 35 ohms, or multiples thereof, so that the center-scale marking of the "ohms" range of the meter is 35.

The usual series system of multi-

plier resistors is employed with this meter for d.c. potential measurements as indicated by the heavy lines of Figure 4. The multiplier resistor values are 1000 ohms per volt for each range. The first multiplier has a value of 4700 ohms for the 5-volt range, because the meter resistance is 300 ohms; the sum total of these two values gives the necessary value of 5000 ohms.

The elements involved in a.c. potential and capacity measurements are indicated by the dotted lines in Figure 4, but before discussing the functions of these elements it is first necessary to go into more detail concerning some of the inherent characteristics of instrument rectifiers.

Alternating current values, as measured by ordinary a.c. instruments, will not be indicated as having the same values when rectified and measured with a d.c. instrument.

For example, an alternating potential of 100 volts as measured with an ordinary a.c. voltmeter will be indicated after rectification by a d.c. instrument as having a value of about 90 volts. This is because the usual types of a.c. voltmeters, which are not sufficiently sensitive for many modern requirements, have the desirable characteristic of indicating *root mean square* (r.m.s.) values, whereas sensitive d.c. instruments indicate *average* values which are lower than *root mean square* values by the ratio of 1:1.11. In other words, *average* values must be multiplied by 1.11 in order to obtain correct *root mean square* values. This condition is true for sine-wave forms which are approximated in commercial practices. This characteristic suggests that some means must be provided for correcting the sensitivity of the meter between measurements of a.c. and d.c. values, so as to provide for this ratio between *root mean square* and *average* values. In the tester under discussion, the correction is effected by means of a series and parallel condensers which have the effect of reducing the total impedance of the circuits for measuring a.c. values, so that more current is permitted to pass through the meter movement than is the case when using the tester for d.c. measurements. In this connection it may be well to state that the ratio of 1.11 may be modified by the electrical characteristics of the rectifier unit or of other circuit elements.

The "current density" characteristic of instrument rectifiers is another one which must be taken into consideration in the design of a universal tester. This characteristic manifests itself in the form of an

[[By Floyd Fausett]]

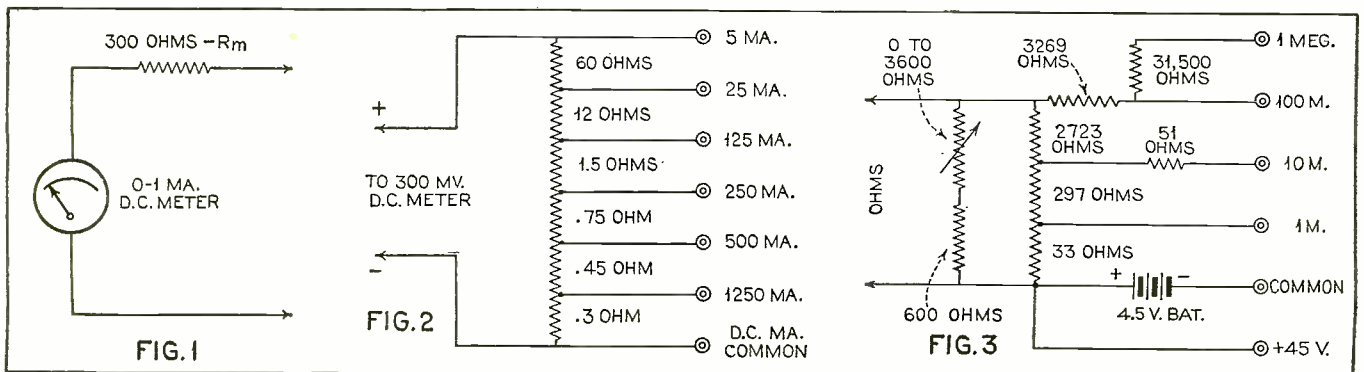
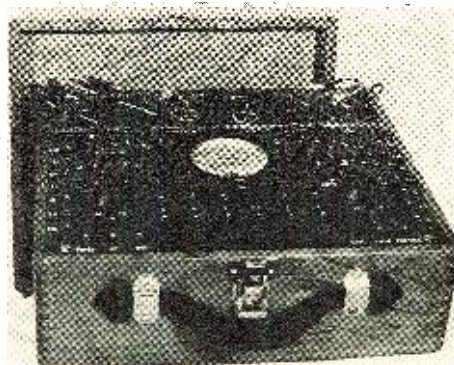

increase in the rectifier resistance with a decrease in the electrical load. This accounts for the departure from a linear scale in the usual rectifier type a.c. instrument. The current density characteristic may be better understood by a tabulation of resistance values corresponding to current values, based on a typical rectifier unit which has an internal resistance value of 500 ohms, with a load of 1 milliampere, as shown in Table 1.

The effect of the current density characteristics is reduced, however, by the usual multiplier resistors as used in a.c. voltmeters of the rectifier type. For example, a rectifier having the above tabulated resistance values, when used with a multiplier resistor for a 5-volt measuring range with a meter such as that described herein, would require a total circuit resistance of 4500 ohms, this value being obtained by dividing 5000 by the form factor of 1.11. At half-scale meter needle deflection, the total resistance of the circuit will increase about 260 ohms, as indicated in the above table, so that the increase in the total resistance of the circuit is about 5.8%, as contrasted with an increase of about 52% if the meter were used without a multiplier for measuring a current value corresponding to half-scale deflection. The effect is still further reduced when the range of the meter is extended to higher voltage ranges.

In the design of the tester under discussion, it was found advantageous to minimize the effect of the current density characteristic of the instrument rectifier by utilizing a series condenser (C5, Figure 4) for the low range as a multiplier reactor, instead of utilizing a multiplier resistor. This arrangement constitutes an impedance circuit wherein the capacitive reactance is about 90 degrees out of phase with the meter and rectifier resistance, so that the impedance elements may be represented by a right-angled triangle in which the resistance of the circuit is represented by a short leg of the triangle and the capacitive reactance by a long leg; the resulting impedance is, of course, represented by the hypotenuse of the triangle. This condition is graphically represented in Figure 5, in which the resistance is shown as a value of 800 ohms, obtained by adding the resistance of the meter to the resistance of the rectifier unit with a full-scale deflection load of one milliampere. The capacitive reactance is shown as having a value of 3800 ohms, which is the reactance of a 0.7 mfd. capacitor. The resulting impedance is 3890 ohms, as determined by the solution of the impedance formula. These values were taken from a typically constructed analyzer so that the form factor of the rectifier unit is about 1.29 in this case, determined by dividing 5000 by 3890.

It will be observed from Figure 5 that slight variations in the length of that side of the triangle which represents the resistance will have comparatively little effect on the length of the hypotenuse, whereas the variations of the rectifier resistance would be considerable if the elements of the circuit impedance were additive; that is, capable of

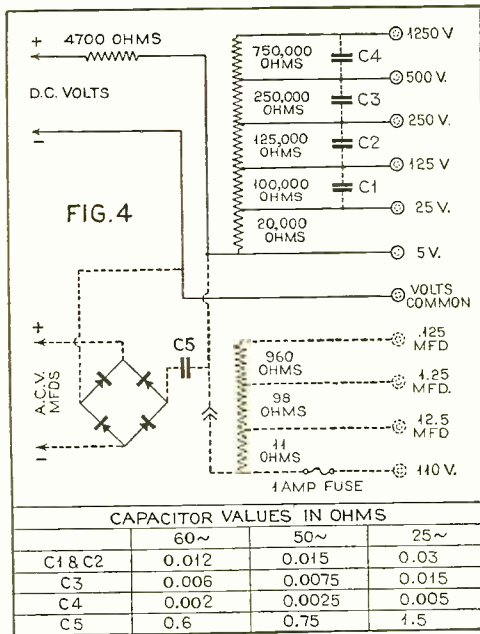

TABLE 1

MILLIAMPERES	OHMS
1.0	500
0.9	530
0.8	560
0.7	620
0.6	685
0.5	760
0.4	870
0.3	1300
0.2	1300
0.1	2000

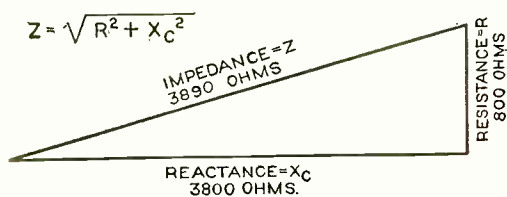

FIG. 5

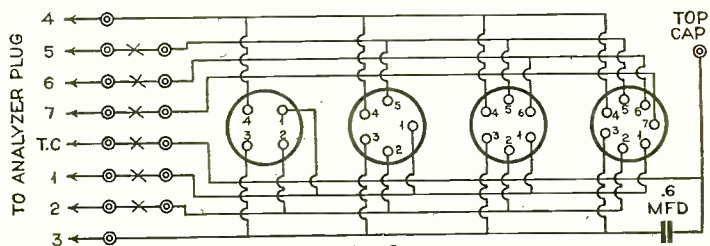

FIG. 6

being represented by a straight line instead of by a triangle such as that described. It was shown above that the increase in the total resistance of a 5-volt circuit at half-scale deflection, by reason of the current density characteristic, when a 4500-ohm multiplier resistor is employed, amounted to 5.8% of the total resistance. It is now apparent that an increase of 260 ohms of the resistance leg of the triangle increases the length of the hypotenuse only 50 ohms, so that the increase in the impedance amounts to less than 1.3%. In other words, by using a condenser as a multiplier reactor instead of using a multiplier resistor for the low-voltage a.c. range, readings are made to conform very closely to uniform scale distribution for practically all measuring requirements.

The adjustment of the 5-volt a.c. range of each type 333 tester is accomplished by adjusting the capacity C5 until the meter needle deflects to the full-scale position with an applied a.c. potential of 5 volts. This condenser also serves to isolate the a.c. from the d.c. measuring functions of the tester, so that the meter will not register d.c. values when the switch is set for a.c. measurements, or vice versa.

After having adjusted the 5-volt range for measuring a.c. potentials, it is next necessary to consider the means employed for adjusting the higher ranges. As stated before, it is necessary to pass more current through the meter when measuring a.c. values than is required when measuring d.c. values. This is accomplished in the higher a.c. ranges by by-passing the multiplier resistors which are required for d.c. potential measurements. In view of the fact that another triangle is formed when a range somewhat higher than the basic 5-volt range is considered, it may be found that the higher range, indicated in Figure 4, as a 25-volt range, may not require a by-passing capacitor. A triangle which would represent the impedance of the 25-volt range would have a reactance leg represented by the capacity C5 as in the first triangle, but with a resistance leg increased from 80 to 20,800 ohms. The resulting impedance, represented by the hypotenuse of the new triangle, may generally be found sufficient for the 25-volt range. However, the ranges above the 25-volt range requires the use of small by-pass condensers. Their values average 0.012 mfd. for the 125-volt and 250-volt ranges, 0.006 mfd. for the 500-volt range and 0.002 mfd. for the 1250-volt range.

The means employed for obtaining a uniform scale distribution for a.c. indications, as described above, are found to be accurate within 5% of full-scale values which is generally accepted as being sufficient for all practical a.c. measurement purposes.

The dotted lines in Figure 4 also indicate a divided shunt with a normally open switch provided for capacity measurements on a uniformly divided scale of the meter, utilizing an ordinary 110-volt a.c. power supply potential in series with the unknown condenser and one of the indicated capacity-measuring ranges. A fuse is provided for protecting the meter and shunts against (Continued on page 177)

Mathematics in Radio

Calculus and Its Application in Radio

ONE of the most practical applications of the integral calculus is found in the determination of the areas which are bounded by various shaped curves, arcs or lines. Thus, the average and effective or root mean square values of alternating currents and voltages are more accurately determined, power is more easily calculated, and numerous other theories more easily proven.

Integral calculus shows us a very easy and interesting method for the calculation of various areas. The determination of simple areas, such as those which would be obtained by the boundary of straight lines can be quite readily accomplished without the use of calculus since the study of geometry has shown us these results. Thus, if it becomes necessary to find the areas of the shaded portions of Figures 1 or 2, it is only necessary to recall our geometry for the area of a triangle or by actually counting the number of square feet or inches as the case may be. The determination of areas, however, which are bounded by more irregular curves, such as those shown by Figures 3 to 6, inclusive, are not accurately determined except by the methods of calculus or by other methods using a system of approximations which become rather involved and very tedious. We shall now show how the methods of integral calculus make this problem a very simple one.

Let us consider the graph shown in Figure 1. The equation of the line OB is obviously $y=x$. Let us suppose that we wish to determine the area of the shaded portion between the limits of $x=0$ and $x=4$. To indicate the method of the calculus, let us investigate for the present the relations

(a) $\int x \, dx$

Integrating (a) and recalling the above rules for integration, we have

(b) $\int x \, dx = \frac{x^2}{2} + c$

Now, when $x = 4$, (b) becomes

(c) $\frac{16}{2} + c$

Again, when $x = 0$, (b) becomes

(d) $0 + c$

Subtracting (d) from (c);

(e) $\frac{16}{2} + c - (0 + c) = \frac{16}{2} + c - c = \frac{16}{2} = 8$

It is noticed that the constant of integration "c" disappears. The result obtained above from (e), giving us the value of 8 is actually the area of the shaded portion of Figure 1. That this is true is apparent from the figure by actually estimating the enclosed area and also recalling that the area of a triangle is equal to $\frac{1}{2}$ its base times its altitude. Since the base is equal to 4 and its altitude is equal to the same value, the area is then 8 square feet or inches as the case may be.

The above method of mathematics which was employed is

By J. E. Smith*

Part Twenty-two

indicated by the symbol:

$$\int_a^b y \, dx$$

and is the numerical measure of the area bounded by the curve $y = f(x)$, the axis of x , and the ordinates of the curve when $x = a$, $x = b$.

In order to make this a little more clear, let us find the area of the shaded portion of Figure 2.

We have $y = x$ and from the above relation:

(a) $\int_a^b y \, dx = \int_a^b x \, dx$

We see from the figure that $a = 2$ and $b = 4$. Integrating

(b) $\int_a^b x \, dx = \left[\frac{x^2}{2} \right]_a^b$

Substituting in (b) for the variable "x" first the upper limit (4) and then the lower limit (2) and subtracting the last result from the first, we have:

$$\frac{16}{2} - \frac{4}{2} = 6 \text{ (area of shaded portion).}$$

This can actually be proven by the count of the number of squares included in the shaded portion of Figure 2.

Let us investigate the shaded portion of Figure 4, and determine its area by the methods given. To indicate the procedure:

(a) $y = x^2$; $a = 1$, $b = 2$

(b) $\int_a^b y \, dx = \int_1^2 x^2 \, dx$

Integrating (b)

(c) $\int \left[\frac{x^3}{3} \right]_1^2$

Substituting and subtracting:

(d) $\frac{8}{3} - \frac{1}{3} = \frac{7}{3} = 2 \frac{1}{3}$ (area of shaded portion)

Average Current

We are now in a better position to calculate more accurately the average current which flows in an alternating current circuit. Of course, it is already known that the average value is equal to .636 times the maximum value. Let us prove this relationship by the use of calculus.

Considering Figure 6, we have in dealing with alternating currents:

- i = instantaneous current
- I_{max} = maximum current
- I_{avg} = average current

To get the average current value of a sine wave; We have:

(Continued on page 187)

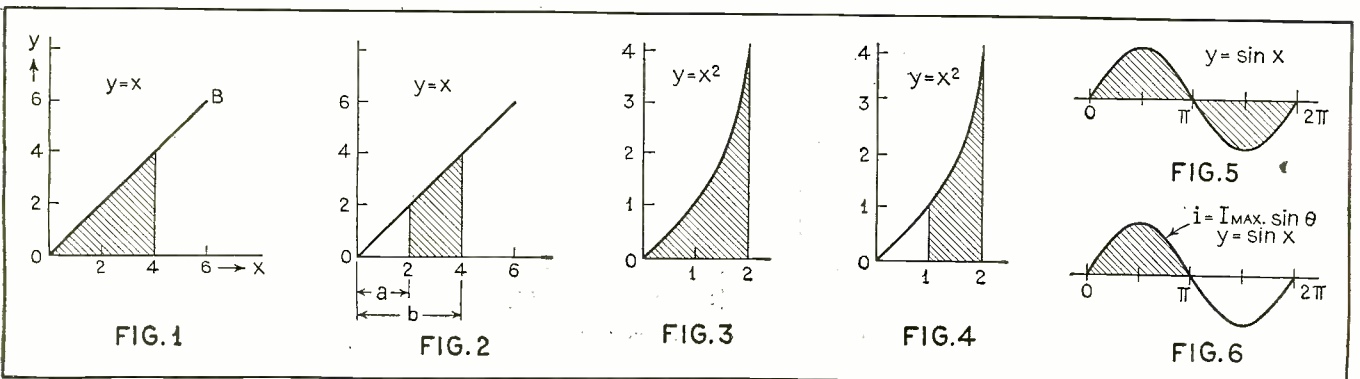

* President, National Radio Institute.

MODERN EQUIPMENT AND TECHNIQUE FOR SERVICING RECEIVERS

By Joseph Kaufman

Part Two

FOR want of a better name, let us call the method that I am recommending "the direct stage-by-stage elimination method." Some will say that it is the good old-fashioned technique, and I don't deny it. Illustrating the use of the N.R.I.-Philco all-purpose set tester will bring out the essentials of the method. Other makes of test equipment are equally adaptable to this system of diagnosis. In fact, any combination of r.f. oscillator and magni-range universal meter will serve, such as the Readrite No. 550 oscillator (Figure 1) and the Shallcross No. 610 general-purpose meter (Figure 2), or the combination equipment put out by Weston, Supreme, etc.

When calling on a customer, first allow the customer to tell you what he thinks the trouble is. After all, the serviceman is something of a doctor. The normal thing is to go to the receiver, look into the chassis, be on the lookout for odors which indicate burned-out or overheated parts, see if anything is loose and the tubes are in place. Turn the receiver on and while the tubes are heating up, check the aerial and ground leads and any extensions which may be in use. Then tune in a signal.

Isolating the Trouble

If no signals are heard, the first thing to do is to look for burnt-out tubes. If they light, then the output meter is connected to the output stage and the oscillator, by means of the shielded lead, is connected to the input of the detector or, in the case of a superheterodyne receiver, the second detector. (One of the probing leads should have a series .001 mfd. condenser.) Failure to hear the oscillator signal indicates either a defect in the detector or in the audio stages. By advancing the output indicator stage by stage, the defective stage may be located. Then test to find out whether it is in the input or output of the stage. Try a new tube to eliminate the possibility of an internal tube defect.

Assuming that everything so far is o.k., proceed to advance the signal generator connection, stage by stage through to the i.f. or r.f., as the case may be, until the defective stage is located.

Once it is located, the voltmeter test leads can be connected to the tube socket to tell you whether there is voltage supply to this stage. In any case, regardless of what the error may be in the stage, the correction must necessarily be made by removing the chassis from the cabinet. Whether the repairs are now made in the home or the chassis taken to your shop depends entirely upon the requirements of your trade.

If you find that a signal is received when the set is first turned on, the tubes should be tested to determine whether they are in perfect condition. In this case the oscillator is connected to the aerial and ground of the receiver and the output indicator connected to the output stage.

Starting with the rectifier tube, the tubes already in the receiver are substituted one by one with tubes from your stock, known to be good. The oscillator should be adjusted so the output meter reads mid-scale. In the case of receiving sets having a.v.c., the oscillator output is adjusted so that it is well below the threshold condition—that is, the region where changes in oscillator output cause marked changes in receiver output.

If the output goes up to marked degree in trying a new tube in some particular socket, it is absolute proof that the set will work better with that new tube than with the old one. A demonstration like this to a customer is far more convincing than any sales talk. It sells tubes and satisfies the customer. The serviceman should not argue that a complete set of tubes must be carried with him for this method, for he must carry tubes for replacement regardless of what method of tube testing he uses.

All new or good tubes having similar emission characteristics may have different dynamic characteristics, therefore, it is wise to interchange similar tubes in a receiver so that the best detector, amplifier, a.v.c. control, etc., is inserted in the proper position. A line-up of this type will surprise you and will give the receiver the pep that you want. In case of a.v.c. receivers, the output meter should be watched for a few minutes to see that the output does not go up. If it does, gassy controlled tubes are indicated.

Point-to-Point Tests

Failure to get a peppy response with this tube line-up procedure indicates either incorrect operating voltages or misalignment of the r.f., i.f. and oscillator tuning systems. To properly take care of this condition, a shop technique is required and the chassis should be removed for a careful check.

Once the receiver has been taken to the shop, you are not compelled to work under pressure and may give the repair of the machine deliberate, careful attention. If a defect has been indicated in a given stage, then the ohmmeter track-down method may be employed. If you have information on the point-to-point resistances of the set, you may apply it to that particular stage, analyzing the possible defect by the overall and individual resistance values. Or, with the use of a circuit diagram (every serviceman should subscribe to a circuit diagram service), check the components in the defective stage.

When the defective part has been found, replacements or repairs, as the case may indicate, should be made.

Once the defect has been repaired, the chassis should be placed in operation again and the oscillator output test repeated. Testing and balancing the tubes will improve the performance. Laying the chassis on end, the voltages between cathode and the electrodes should be checked. If you understand (Continued on page 179)

A GENERAL PURPOSE METER

Figure 2. Once the trouble in a receiver has been traced to one stage or circuit by means of an oscillator and output meter, a meter unit such as the one shown here will permit measurements of all components of the troublesome circuit, including condensers, resistors, coils, tubes, potentials, etc.



A MODERN SERVICE UNIT

Figure 1. This oscillator constitutes a signal generator for frequencies in the broadcast and i.f. ranges. It also includes a dual-range output meter. With an instrument such as this the defect in a receiver can be quickly localized

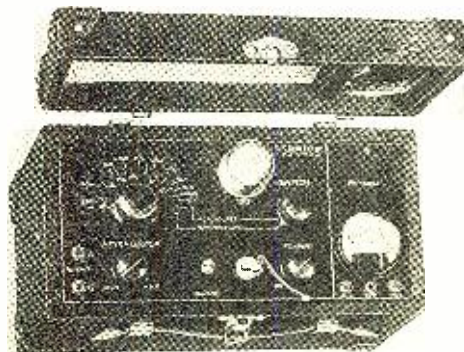



With the Experimenters

Testing Electrolytic Condensers, Sensitive Photo-cell Relay, Handy Wire Connectors, Home-Made Condenser Microphone, Novel Analyzer Switching Arrangement, Code Practice Oscillator, Circuit for High-Resistance Photo-cells

Testing Electrolytic Condensers

Although there are a number of methods for measuring accurately the capacity and leakage of electrolytic condensers, such methods involve the use of apparatus which

Conducted by
S. Gordon Taylor

circuit may easily be constructed at low cost, most of the material being available in most service laboratories. It is used in conjunction with the chart shown, which is plotted as capacity in microfarads against effective impedance, expressed in current readings of the condenser.

The most important point to remember in connection with the use of this test circuit is to connect the electrolytic condenser with the proper polarity with respect to the polarity of the voltage source A. The capacity C1 must be a paper type condenser. The resistor R1 is used to protect the meter in case of a short in the condenser under test. The circuit is foolproof in every other way.

To operate the test circuit, connect the electrolytic condenser to be tested in the position shown by C2 in the diagram, with the a.c. source disconnected. This for leakage test. The initial current will be rather high for the first few minutes, but should drop quickly to a maximum of .5 milliampere per microfarad. The lower the current, the better. This current is measured by the a.c. milliammeter. If the leakage does not drop to that low value, it indicates a leaky or shorted condenser. It is best to leave the condenser connected to the d.c. source for about five minutes before a reliable current reading is taken. After the leakage reading has been taken, the a.c. may be plugged in, connecting it across the circuit. Rheostat R2 is then adjusted until the voltmeter reads 110 volts. This reading should be obtained as accurately as possible, as the chart is based upon the correct voltage. The current readings as shown on the milliammeter should then be noted, and by consulting the chart shown here the capacity in microfarads

is found. If desired, chart readings may be done away with by calibrating the milliammeter with another scale, reading the capacity directly, as taken from the chart. Thus the regular scale may be used to read leakage current and the capacity scale may be used to read capacity direct.

MORRIS CHERNOW,
Brooklyn, N. Y.

Sensitive Photo-cell Relay

For a considerable length of time I have been experimenting in photoelectricity. I

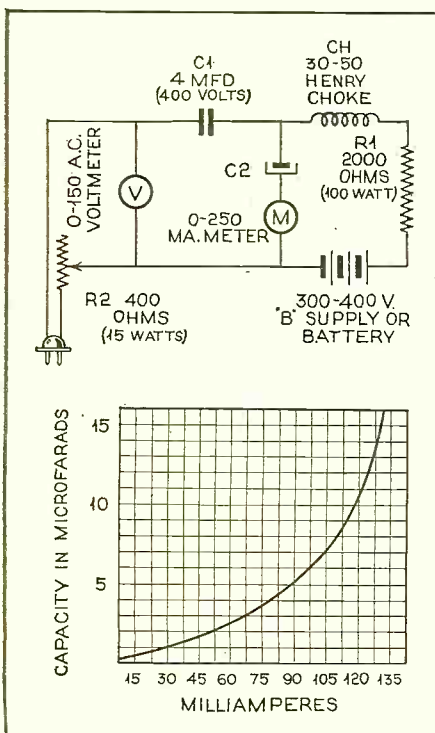

is usually beyond the average serviceman. A simple method in use by the writer for both capacity and leakage tests makes use of the diagram shown herewith. This test

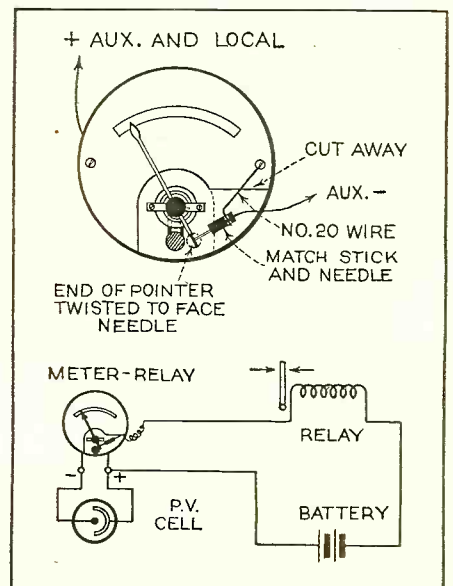

built the pickle-bottle photo-voltaic cell as described in October, 1932, issue of RADIO NEWS. I could readily think of many uses

for it, but this meant, so I thought, the purchase of a sensitive relay, which I learned, cost about ten dollars. Ten dollars might just as well have been fifty dollars, and I was just deciding to let my precious pickle bottle join the relatives in the ashcan when I hit upon the idea of making a relay from an old meter.

I happened to have an old Jewell pattern 135, 0-5 voltmeter. I took the case off and cut in ahead of the multiplier resistance, connecting the negative terminal directly to the moving coil. This made it act as an uncalibrated milliammeter. I cut away the lower right-hand corner of the scale plate, clamped a piece of No. 20 wire under the scale-plate screw and wrapped its other end around a piece of match stick about 1/4 inch long. Through this I forced the pointed half of a small needle which I had cut in two. A fine wire is soldered which leads out to the terminal of a secondary relay. Then I twisted the stick and needle down into its place opposite the lower end of the pointer as is shown in diagram. The little disc at the end of the pointer was then twisted till it struck the needle squarely when let back to about .5 on the scale. The positive terminal of the meter forms the other terminal of this relay. I connected it up as indicated, using as a secondary relay a simple affair consisting of earphone electromagnets and activated by a flashlight cell.

This relay system worked amazingly well and would break contact on about 500 microamperes from the photo-cell. I also used it with a dry disc type cell and it worked well there. When using the voltaic cells, allowance for the dark current must be made in adjusting the needle.

After considerable use the needle makes a small socket in the pointer disc and thus is very reliable in making the contact.

To make the device to which the relays are connected work when light is directed upon the photo-cell, the secondary relay must be of the double-contact type.

E. C. REID,
Walkerville, Ont., Canada.

Connectors from Clothes Fasteners

Because they provide positive contact yet can be separated easily, ordinary snap clothes fasteners make excellent electrical connectors. Only the tinned, unpainted kind should be used. The halves can be soldered to the ends of wires, tacked to boards, soldered to

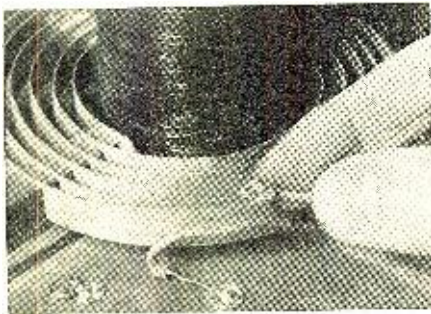

bolt heads and otherwise fastened in place. They are particularly useful on the experimental radio set, toys, and even on more sizeable equipment.

WALTER E. BURTON,
Akron, Ohio.

Condenser Microphone

Herewith a sketch of a condenser microphone which I have constructed, and which think others would be glad to construct due to its many advantages, especially the diaphragm clearance feature which you will notice is automatically taken care of by inserting the back plate in a bakelite disc and recessing it .002 of an inch below the surface of the bakelite. The back plate retainer edge

Practical Analyzer Switching

Herewith is a print of analyzer I have designed, which I believe will be of interest.

Switches 20-26 are a radical change in analyzers. They are of the s.p.d.t. type with a neutral position. By throwing one up and any other down, any circuit may be thrown

By throwing any one of them, the meter is put in series with any circuit for current measurements. Pup jacks 20 to 26 are for making connections to tubes with external connections.

There are more improvements possible for the man who wants the best: 4, 5, 6 and 7-

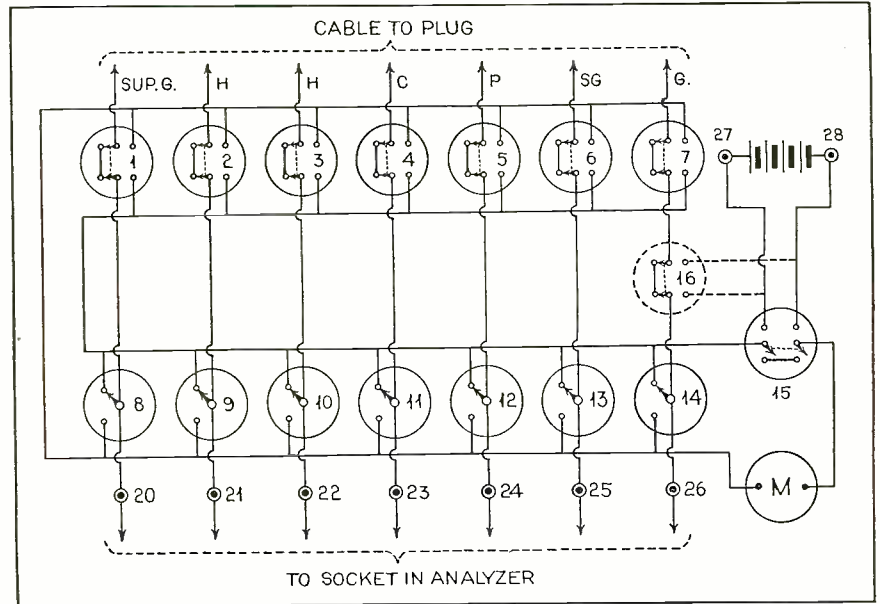

across the meter. By throwing switch 15, a.c. or a battery may be cut in the circuit. Thus voltage, resistance or capacity of any circuit in a radio may be found without pulling the chassis.

Another improvement is in the symbol chart at the top of the switches. A diagram of any tube is right before your eyes. With so many different tubes now in use it is a necessity.

Switches 1 to 7 are of the d.p.d.t. type.

is forced up against the diaphragm by the stretching ring. This gives uniform stretching of the diaphragm and assures the proper clearance.

The construction, of course, requires the

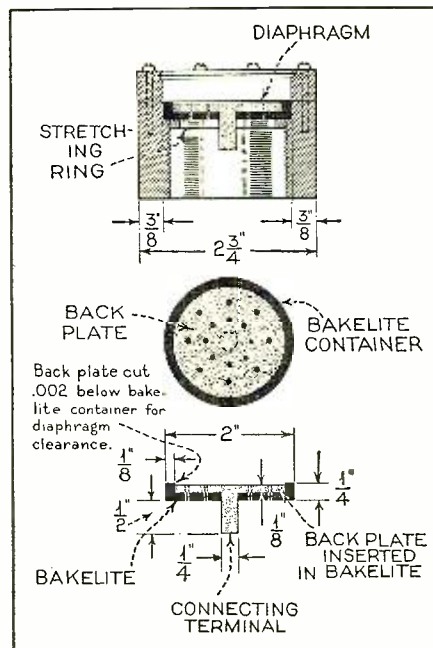

use of a lathe. The material used was bronze, which can be secured at most any electrical motor repair shop and is used for bearing replacements.

This microphone has been tried by amateurs and broadcast stations and the results obtained are equal to any used by them and

works into the standard microphone amplifiers.

This analyzer with one of the rectifier type meter combinations is a pleasure to use.

J. W. DAVIES,
Scranton, Pa.

R. A. NESTER,
Richmond, Va.

A Pentode Code Practice Set

The simple audio-frequency oscillator shown in the accompanying photo and circuit uses the same type of circuit as the pentode r.f. oscillator described on page 680 of

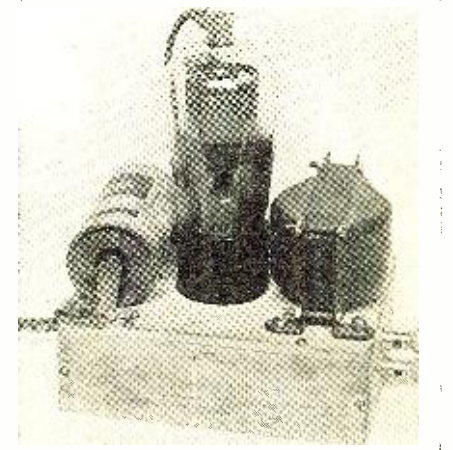

RADIO NEWS for February, 1932, but uses a type -34 r.f. pentode instead of a -33, because the -34 draws only about one-fourth as much as much filament current as the -33. A single 1 1/2-volt flashlight cell of the large size is used for lighting the filament and two 3-volt flashlight batteries for the B supply.

Very few parts are needed to build this code practise oscillator. All components are (Continued on page 191)

A UNIVERSAL A. C.-D. C. OR BATTERY OPERATED PORTABLE P. A. SYSTEM

By Leon Littman

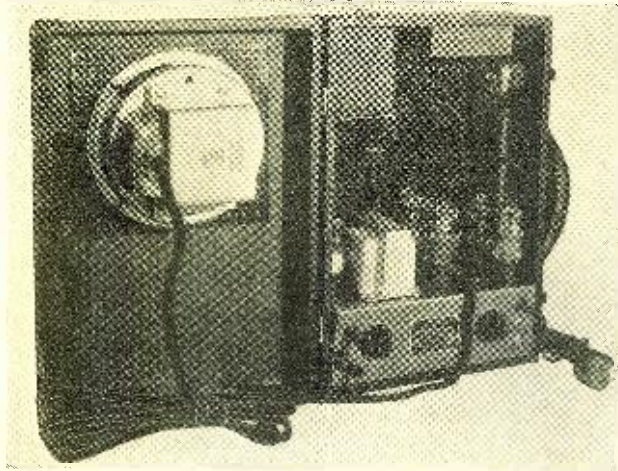

THIS how-to-build article on a universal five-tube public-address system should have unusual interest for the serviceman or radio dealer, as it means a new road to additional revenue. Both the serviceman and the dealer are realizing more and more that a very profitable source of income lies in renting and selling small light-weight sound-distributing systems.

The compact but powerful sound system described in this article measures 15 inches long by 10 1/4 inches wide by 6 inches deep, weighs only 17 1/4 pounds, including the accessories, and is designed for universal operation on either 110-volt direct or alternating current (50-60 cycles) lighting line supply, or, by the use of a battery cable, as shown in the circuit diagram, Figure 1, it can convert the amplifier for battery operation. When this sound system is operated from 110-volt a.c. supply it is capable of providing 5 watts of output power.

Money Making Possibilities

A few of the many profitable applications that this public-address system can be adapted to, either in renting or in permanent installations, are: window demonstrating, concessionaires, carnivals, chain stores, churches, conventions, department stores, exhibitions, lecture rooms, announcements in train and bus terminals, motor-car announcements, restaurants, schools and numerous other applications that will suggest themselves.

In addition to compact design, simplicity of construction and operation, this low-cost portable system features tone control, removable self-baffle speaker, provision for phonograph and radio input, dual speaker field windings for 6 or 110-volt operation, double-button, carbon-type hand microphone, etc.

The power amplifier as shown in the circuit diagram, Figure 1, employs five tubes in all, which include two -25Z5 voltage-

doubling rectifier type tubes connected in parallel. These tubes, connected in this manner, provide upwards of 220 volts d.c. with more than sufficient current for the tubes and the speaker winding. The use of these new voltage-doubling rectifying tubes eliminates the necessity of a power transformer.

The -37 type tube in the first stage is transformer-coupled into a push-pull power-output stage, using the type -43 power pentode tubes. By referring to the circuit diagram, it will be noted that the volume control R1 is connected across the secondary winding of the universal input transformer, T1. The tone control, which utilizes a potentiometer, R3, and a condenser, C4, is shown connected to the secondary winding of the input push-pull transformer T2. The speaker field winding acts as a choke coil and the two filter condensers, C5 and C6, effectively complete the filtering action.

The d.p.d.t. switch, SW2, is used for operating the equipment interchangeably from d.c. or a.c. lines. The s.p.s.t. switch, SW3, disconnects the 6-volt field winding when the amplifier is operated from 110-volt supply.

The universal input transformer, T1, has two primary windings, one of which is tapped at 200, 500 and 3000 ohms for connection to an electrical phonograph pick-up or a single-button, carbon type microphone. The other winding is center-tapped at 200 ohms, each side, for connection to a double-button, carbon type microphone.

Additional speakers of either the self-excited dynamic type or the magnetic type can be easily adapted to the power-output circuit of this P.A. system. The dynamic type reproducer called for in this amplifier is mounted directly on the cover of the carrying case. This cover is of the removable type, permitting the speaker to be placed in the most convenient location. Extension cables are available for extending the speaker cable or the microphone to a reasonable distance from the amplifier.

This is an appropriate time to outline the power ratings of this universal system as operated under the different voltage supplies. As mentioned previously, it can provide a power output of 5 watts, when operated from a 110-volt, 60-cycle lighting line. When the system is used on a 110-volt d.c. supply line it can produce 2.25 watts power output.

When operated from a 6-volt storage battery and a motor generator delivering 270 volts, it is possible to obtain an output of 7 1/2 watts. In this arrangement the type -43 tubes are replaced by type -42 power tubes. If the amplifier works from a 6-volt storage battery (Continued on page 186)

FIGURE 1. SCHEMATIC CIRCUIT DIAGRAM

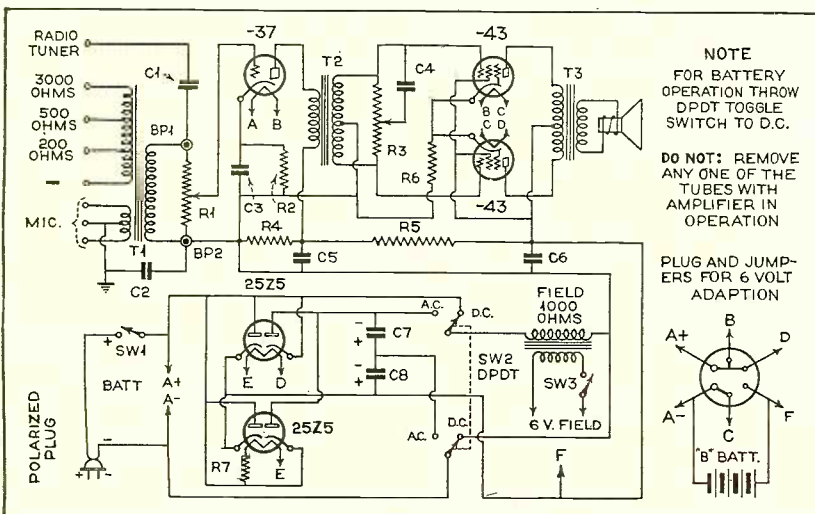

UNDERSIDE VIEW

Figure 2. The power amplifier has been removed from the carrying case, to show the compactness of assembly

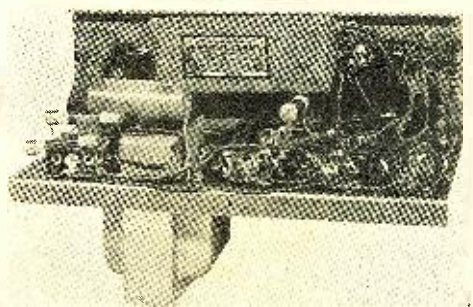

Radio Call Book Section

World Short-Wave Station List

(All time given is Eastern Standard Time)

By Wavelength, Frequency, Call, Location and Time

Meters	kc.	Call	Location	Service and Schedule	Meters	kc.	Call	Location	Service and Schedule
25.02	11,980	PZS	Saigon, Indo-China	Phone to FTK 6-10 A.M.	30.77	9,750	WNC	Deal, N. J.	Phone
25.10	11,950	KKQ	Bolinas, Calif.	Exp.	30.90	9,700	GCA	Rugby, England	Phone
25.10	11,950	FTA	Ste. Assise, France	Phone to Rabat, irr. 7-11 A.M.	30.90	9,700	WMI	Deal, N. J.	Phone
25.16	11,923	RW50	Moscow, U. S. S. R.	Broadcast	30.90	9,700	LQA	Buenos Aires, Arg.	Phone
25.20	11,900	FYA	Pontoise, France	Broadcast for Madagascar 11:15 A.M. 1:15 P.M. daily	31.00	9,675	T14NRH	Heredia, Costa Rica	Broadcast; daily except Sunday 4:30-6:30 P.M.
25.21	11,895	VE9DR	Montreal, Que.	Exp.	31.10	9,640	HSP2	Bangkok, Siam	Broadcast
25.24	11,880	W9XF	Downer's Grove, Chicago, Ill.	Exp.	31.20	9,620	DGU	Nauen, Germany	Phone to Egypt
25.25	11,870	W8XK	Saxonburg, Pa.	Relays KDKA; 4:30-10 P.M. daily	31.23	9,600	LGN	Bergen, Norway	Phone
25.26	11,870	VUC	Calcutta, India	Broadcast	31.23	9,600	XETE	Mexico City, Mex.	Broadcast 2:30-5:30 P.M. 7-11 P.M.
25.28	11,865	GSE	Daventry, England	Broadcast	31.23	9,592	LQA	Buenos Aires, Arg.	Phone
25.30	11,860	VE9CA	Chicago, Ill.	Exp.	31.23	9,592	CT1AA	Lisbon, Portugal	Broadcast; 5-7 Tue., Fri.
25.34	11,840	WUXA	Chicago, Ill.	Relays WCFL	31.27	9,590	VK2ME	Sydney, Australia	Broadcast; Sunday mornings
25.35	11,835	VE9HX	Halifax, N. S.	Exp.	31.28	9,585	W3XAU	Byberry, Penna	Broadcast; relays WCAU
25.36	11,830	W2XE	Wayne, N. J.	Broadcast; relays WABC 2-4 P.M. daily	31.28	9,585	VE9DR	Montreal, Que.	Exp.
25.40	11,810	I2RO	Rome, Italy	Broadcast; 11:30 A.M.—12:30 P.M.; 1:15-6 P.M. daily	31.28	9,585	GSC	Daventry, England	Broadcast
25.42	11,800	W1XAL	Boston, Mass.	Broadcast; irr.	31.30	9,580	HBL	Geneva, Switzerland	Broadcast; Sun. 5-5:45 P.M.
25.47	11,780	VE9DR	Drummondville, Que.	Exp.	31.33	9,570	W1XAZ	Springfield, Mass	Broadcast 4:30-12 P.M. daily
25.51	11,760	DJD	Zeesen, Germany	Exp.; tests with XAM	31.33	9,570	SRI	Poznan, Poland	Broadcast
25.51	11,750	GSD	Daventry, England	Broadcast	31.36	9,560	DJA	Zeesen, Germany	Broadcast
25.53	11,750	PHI	Huizen, Holland	Broadcast irr.	31.48	9,530	W2XAF	Schenectady, N. Y.	Broadcast; 7-10 P.M. Sun., Mon., Wed., Fri.; 7-11 P.M. Thurs., Sat.
25.56	11,730	VE9JR	Winnipeg, Man.	Broadcast	31.51	9,520	OKY	Skamleback, Denmark	Broadcast; temporarily changed to 49.5 meters
25.60	11,720	FYA	Pontoise, France	Broadcast; 3-5 P.M.; 6-10 P.M.	31.55	9,510	VK3ME	Melbourne, Australia	Broadcast
25.63	11,705	VE9BA	Montreal, Que.	Exp.	31.55	9,510	GSB	Daventry, Eng.	Broadcast
25.63	11,705	YVQ	Maracay, Venezuela	Exp.	31.58	9,500	PRBA	Rio de Janeiro, Brazil	Broadcast
25.65	11,680	KIO	Kahuku, Hawaii	Phone to KES	31.58	9,500	YV3BC	Caracas, Venezuela	Exp.
25.68	11,660	PPQ	Rio de Janeiro, Brazil	Exp.; irr.	31.60	9,490	W2XBJ	Rocky Point, N. Y.	Exp.
25.73	11,630	CGA	Drummondville, Can.	Phone	31.63	9,480	PLW	Bandoeng, Java	Phone to Australia
26.00	11,530	XAM	Merida, Yucatan	Tests with XDA	31.71	9,455	WKJ	Rocky Point, N. Y.	Exp.
26.00	11,490	GBK	Bodmin, England	Phone	31.74	9,450	WES	Rocky Point, N. Y.	Exp.
26.10	11,470	IBDK	S. S. Elettra, Marconi's Yacht	Exp.	31.86	9,415	PLV	Rocky Point, N. Y.	Exp.
26.22	11,435	DHC	Nauen, Germany	Phone	1.90	9,400	XDC	Mexico City, Mex.	Phone to Australia and Sumatra 4-8 A.M.
26.46	11,340	DAN	Norddeich, Germany	Time signals; 7 A.M., 7 P.M.	31.97	9,375	XDA	Mexico City, Mex.	Exp.
26.83	11,180	CT3AQ	Funchal, Madeira	Broadcast; Tue., Thurs. 5-6:30 P.M.; Sun. 10:30 A.M.—noon	31.97	9,375	EH9OC	Berne, Switzerland	Phone
27.00	11,111	XFD	Mexico City, Mex.	Broadcast	32.00	9,370	CT3AQ	Funchal, Madeira	Broadcast
27.28	10,990	ZLT	Wellington, N. Z.	Phone	32.10	9,330	CGA	Drummondville, Que.	Phone to GBK 6 P.M.-6 A.M.
27.30	10,980	ZLW	Wellington, N. Z.	Exp.	32.33	9,280	GCB	Rugby, England	Phone to ships, irr.
27.35	10,975	OCI	Linna, Peru	Phone to HJY	32.40	9,250	GBK	Bodmin, England	Phone to CGA 6 P.M.-6 A.M.
27.68	10,840	KWV	Dixon, Calif.	Phone to Hawaii	33.61	9,200	GBS	Rugby, England	Transatlantic phone
28.04	10,770	GBP	Rugby, England	Phone	32.70	9,170	YVR	Maracay, Venezuela	Phone to Europe
28.09	10,675	WNB	Lawrenceville, N. J.	Phone to Bermuda	32.72	9,162	WNA	Lawrenceville, N. J.	Phone to England
28.12	10,670	CEC	Santiago de Chili	Exp.	32.93	9,104	LST	Olivos, Argentine	Phone
28.22	10,630	PLR	Bandoeng, Java	Phone to Holland and France	33.00	9,091	XFD	Mexico City, Mex.	Exp.
28.28	10,610	WEA	Rocky Point, N. Y.	Exp.	33.00	9,091	XDA	Mexico City, Mex.	Exp.
28.44	10,540	WOK	Lawrence, N. J.	Phone to LSN	33.26	9,020	GCS	Rugby, England	Phone to WND
28.50	10,525	VLK-	Sydney, Australia	Phone to GBP	33.30	9,010	KEJ	Bolinas, Calif.	Exp.
28.80	10,410	PKD	Kootwyk, Holland	Phone	33.50	8,955	TGX	Guatemala City	Exp.
28.80	10,410	KEZ	Bolinas, Calif.	Exp.	33.52	8,950	WEL-	Guatemala City	Exp.
28.80	10,410	LSY	Buenos Aires, Arg.	Phone	33.59	8,925	WEC	Rocky Point, N. Y.	Exp.
28.80	10,410	UIG	Medan, Sumatra	Phone to Java and VLK 3 A.M. 8 A.M.	33.70	8,900	ZLT	Wellington, N. Z.	Phone to VLK
28.80	10,410	KWZ	Dixon, Calif.	Phone	33.79	8,870	NPO	Cavite, P. I.	Time signals 9:55-10 P.M.
28.87	10,390	GBX	Rugby, England	Phone	33.79	8,870	NAA	Arlington, Va.	Time signals 9:55-10 P.M. 2:55-3 P.M.
28.99	10,350	LSX	Buenos Aires, Arg.	Exp.	33.95	8,830	GDLJ	S. S. Homic	Phone
29.04	10,330	ORK	Brussels, Belgium	Phone to OPM	33.95	8,830	GFVW	S. S. Majestic	Phone
29.12	10,300	LSL	Buenos Aires, Arg.	Phone to Europe	33.95	8,830	GKFY	S. S. Minnetonka	Phone
29.16	10,290	DIQ	Koenigs-wusterhausen, Ger.	Exp.	33.95	8,830	GLSQ	S. S. Olympic	Phone
29.25	10,250	PMN	Bandoeng, Java	Phone	33.95	8,830	GMBJ	S. S. Empress of Britain	Phone
29.35	10,220	PSH	Rio de Janeiro, Brazil	Exp.	33.95	8,830	GMJQ	S. S. Belgenland	Phone
29.50	10,163	DDAC	S. S. Europe	Phone	33.95	8,830	VTSX	S. S. Monarch of Bermuda	Phone
29.50	10,163	DDAS	S. S. Bremen	Phone	34.13	8,790	TIR	Cartago, Costa Rica	Phone, afternoons
29.50	10,163	DDBR	S. S. Berlin	Phone	34.50	8,690	W2XAC	Schenectady, N. Y.	Exp.
29.50	10,163	DDCB	S. S. Columbus	Phone	34.56	8,690	GBC	Rugby, England	Phone to ships, afternoons
29.50	10,163	DDCP	S. S. Resolute	Phone	34.68	8,630	WOO	Deal, N. J.	Phone
29.50	10,163	DDCP	S. S. Cap Polonia	Phone	35.00	8,566	IBEJ	S. S. Conto Rosso	Phone
29.50	10,163	DDDT	S. S. Deutschland	Phone	35.00	8,566	ICEJ	S. S. Rex	Phone
29.50	10,163	DDDX	S. S. Hamburg	Phone	35.00	8,566	IDLJ	S. S. Conto de Savoia	Phone
29.50	10,163	DDFA	S. S. Cap Arcona	Phone	35.02	8,570	RV15	Khabarovsk, Siberia	Broadcast
29.50	10,163	DDED	S. S. New York	Phone	35.02	8,570	WOO	Ocean Gate, N. J.	Phone to ships
29.50	10,163	DDFF	S. S. Reliance	Phone	35.42	8,470	DAF	Norddeich, Ger.	Phone to ships
29.50	10,163	DDFT	S. S. Oceana	Phone	35.50	8,450	PRAG	Porto Alegre, Brazil	Phone
29.50	10,163	DDNY	S. S. Albert Ballin	Phone	36.00	8,328	DDAC	S. S. Europa	Phone
29.56	10,150	DIS	Nauen, Germany	Press	36.00	8,328	DDAS	S. S. Bremen	Phone
29.59	10,140	OPM	Leopoldville, Belgian Congo	Phone to ORK	36.00	8,328	DDBR	S. S. Berlin	Phone
29.70	10,100	EHY	Madrid, Spain	Exp.	36.00	8,328	DDCB	S. S. Columbus	Phone
29.84	10,055	ZFB	Hamilton, Bermuda	Phone to WNB	36.00	8,328	DDCG	S. S. Resolute	Phone
29.84	10,055	SUV	Abu Zabal, Cairo, Egypt	Phone to GAA	36.00	8,328	DDCP	S. S. Cap Polonia	Phone
29.98	10,000		Belgrade, Yugoslavia	Broadcast	36.00	8,328	DDDT	S. S. Deutschland	Phone
30.09	9,970	KAZ	Manila, P. I.	Phone to PLV	36.00	8,328	DDDX	S. S. Hamburg	Phone
30.10	9,964	LSL	Buenos Aires, Arg.	Phone to WLO	36.00	8,328	DDEA	S. S. Cap Arcona	Phone
30.15	9,950	CCU	Rugby, England	Phone	36.00	8,328	DDED	S. S. New York	Phone
30.20	9,930	HJY	Bogota, Colombia	Phone to OCI	36.00	8,328	DDFF	S. S. Reliance	Phone
30.30	9,900	LSN	Buenos Aires, Arg.	Phone to Europe and WLO	36.00	8,328	DDFT	S. S. Oceana	Phone
30.33	9,890	LSA	Buenos Aires, Arg.	Phone	36.00	8,328	DDNY	S. S. Albert Ballin	Phone
30.40	9,860	WMI	Lawrenceville, N. J.	Phone to England	36.65	8,185	PSK	Rio de Janeiro, Brazil	Phone to WOK
30.40	9,860	WON	Lawrence Township, N. J.	Phone	36.92	8,125	PLW	Bandoeng, Java	Phone
30.40	9,860	EAQ	Madrid, Spain	Broadcast 5:30-7 P.M. daily, Sat. 1-3 P.M.; 5:30-7 P.M.	37.03	8,100	JJAA	Tokio, Japan	Exp.
30.40	9,860	JJAA	Kemikawa-Cho, Japan	Exp.	37.03	8,100	EATH	Vienna, Austria	Phone
30.47	9,840	FTI	Ste. Assise, France	Phone	37.04	8,110	HCJB	Quito, Ecuador	Broadcast
30.64	9,800	GCW	Rugby, England	Phone to U. S.	37.33	8,035		Rabat, Morocco	Broadcast, Sun. 3-5:30 P.M.
30.68	9,772	EAM	Madrid, Spain	Broadcast	37.59	7,980	VLJ	Sydney, Australia	Phone to Java
30.74	9,760	VLK-			37.77	7,940	VK2ME	Sydney, Australia	Exp.
30.77	9,750	** WOF	VK2ME Sydney, Australia	Phone to Java	37.80	7,940	DOA	Dobbertz, Germany	Phone
			Lawrenceville, N. J.	Phone to England					

(Continued Next Month)

RADIO PROGRAM FEATURES

AN OFFICIAL PROGRAM SERVICE

THE radio receiver is worth only what it receives. One of the main difficulties in broadcast listening is to determine just when the more popular programs are on the air. Most listeners miss as much as 50 percent of the worth-while programs for this reason. RADIO NEWS is therefore presenting this fourth instalment of a monthly broadcast schedule, listing day by day what is felt to be the most noteworthy programs on the air in the evenings, on Saturday afternoons and all day Sunday. The programs have been chosen by a committee of art, music and educational critics, as well as representative listeners. The programs listed are for the period of August 10th-September 10th inclusive. The listings include the name of the program, the time the program is on the air, the type of program, the name of the sponsor, the chain and the national stations through which it is transmitted. To use the lists one should refer to the day of the week and then run down the hours, marking off those programs you wish to listen to. If you want to find the time for a given program, the name of the program is shown in bold face and is easily picked out. The list is correct up to the day of going to press. All time is Eastern Daylight Saving Time. Deduct one hour for Eastern Standard Time, two hours for Central Standard Time, three hours for Mountain Standard Time and four hours for Pacific Standard Time. All programs are sustaining, unless otherwise noted. All time is p. m. unless otherwise noted.

Compiled by
Samuel Kaufman

MONDAYS

- 5:45—**LITTLE ORPHAN ANNIE.** Drama. Sponsor: Wander Co. NBC. WJZ, WBAL, WBZ, WBZA, CRCT, KDKA, CFCF.
- 6:45—**FRANCES LANGFORD AND DICK LEIBERT.** Songs and organ music. NBC. WFAF, WTAG, WRC, WJAR, WCSH, WOC, WHO, WIS, WMAQ, WSAI, WOW, WWNC, WPI, WCKY, WSMB, KSD, WBEN, WSM, WSB, WJDX, KDYL, KPO, WGY, WJAX, KOA, WMC.
- 6:45—**LOWELL THOMAS.** News. Sponsor: Sun Oil Co. NBC. WJZ, WBZA, WHAM, WGAR, WBAL, WBZ, KDKA, WLW, WJR, WSYR, CRCT.
- 7:00—**AMOS 'N' ANDY.** Drama. Sponsor: Pepsodent Co. NBC. WJZ, WBAL, WBZ, WBZA, KDKA, WLW, WGAR, WMAL, CRCT, WRVA, WPTF, WIOD, WFLA. Also, 11:00—WMAQ, WENR, KWK, WREN, KOIL, WTMJ, KSTP, WSM, WMC, WSB, WSMB, KTHS, KDYL, WJR, WOAI, WKY, KOA, KGO, KFI, KGW, WHAM, WFAA, KOMO, KHQ, KPRC, WDAF, WCKY.
- 7:00—**MILDRED BAILEY.** Songs. CBS. WABC, WADC, WOKO, WCAO, KNAC, WGR, WHK, CKOK, WOWO, WDRC, WCAU, WJAS, WEAN, WFBL, WSPD, WQAM, WDBO, WDAE, WGST, WLBZ, WBRC, WICC, WBT, WDOD, KVOR, WCAH, KLZ, WTAQ, WLBW, WBIG, WHP, KTRH, KFAB, KLRA, WFEA, WRBC, WISN, WCCO, WODX, WSFA, WLAC, WDSU, KOMA, WMBG, WDBJ, KSL, K TSA, WTCC, CFRB, WACO, WMT, WVVVA, KFH, WSJS, WORC.
- 7:15—**SAM HERMAN AND FRANK BANTA.** Xylophone and piano. NBC. WFAF, WTAG, WJAR, WCSH, WLIT, WBEN, WMAQ, WSAI, WOC, WHO, WIS, WFLA, WIBA, WEBB, KFYR, WAPI, WSB, WJDX, WKY, WSMB, KVOO, KTBS, WOAI, KGO, KFSD, KOMO.
- 7:15—**ROLLICKERS.** Male Quartet. NBC. WJZ.
- 7:30—**DOLPH MARTIN'S ORCHESTRA AND TRAVELERS' QUARTET.** Sponsor: Tide Water Oil Co. CBS. WABC, WOKO, WCAO, WNAC, WGR, WDRC, WCAU, WJAS, WEAN, WFBL, WJSV, WLBZ, WHP, WFEA, WHEC, WORC.
- 7:45—**THE GOLDBERGS.** Drama. Sponsor: Pepsodent Co. NBC. WFAF, WEEI, WSAI, WENR, WOW, WTAG, WJAR, WCSH, WLIT, WFER, WRC, WGY, WBEN, WCAE, WTAM, WWJ, WDAF.
- 7:45—**BOAKE CARTER.** News. Sponsor: Philco Radio & Television. CBS. WABC, WCAO, WNAC, WGR, WBBM, WHK, CKOK, WCAU, WJAS, WBT, WJSV.
- 8:00—**SOCONYLAND SKETCHES.** Drama. Sponsor: Standard Oil Co. of N. Y. NBC. WFAF, WTIC, WTAG, WEEI, WJAR, WCSH, WGY, WBEN.
- 8:00—**CLICQUOT CLUB ESKIMOS.** Harry Reser's Orchestra. Sponsor: Clicquot Club Co. NBC. WJZ, WBZ, WBZA, WBEAL, WHAM, KDKA, WGAR, WLS, KWK, KWCR, KOIL, WREN, KSO, WCKY, WMAL.
- 8:00—**SINGIN' SAM.** Sponsor: The Barbasol Company. CBS. WABC, WOKO, WCAO, WNAC, WGR, WGN, WKRC, WHK, WDRC, WFBM, KMBC, WCAU, WJAS,

- WEAN, KMOX, WFBL, WSPD, WJSV, WCKY, WCCO, WADC.
- 8:30—**KATE SMITH LA PALINA PROGRAM.** Sponsor: Congress Cigar Co. CBS. WABC, WADC, WOKO, WCAO, WGR, WGN, WKRC, WHK, WOWO, WFBM, KMBC, WHAS, WCAU, WJAS, KMOX, WFBL, WSPD, WJSV, CKOK, WHEC, WMT, WKBN, WCCO.
- 8:30—**POTASH AND PERLMUTTER.** Drama. Sponsor: Health Products Co. NBC. WJZ, WBAL, WMAL, WGAR, WCKY, WLS, WJR, WHAM, KDKA.
- 8:45—**ABE LYMAN'S ORCHESTRA AND IRVING KAUFMAN.** Sponsor: Sterling Products, Inc. CBS. WABC, WADC, WOKO, WCAO, WNAC, WGR, WGN, WKRC, WHK, WDRC, WFBM, KMBC, WHAS, WCAU, WJAS, WEAN, KMOX, WFBL, WSPD, WJSV, CKOK, WCCO.
- 8:45—**FERDE GROFE'S ORCHESTRA WITH CONRAD THIBAUT.** Sponsor: Philip Morris & Co. NBC. WFAF, WEEI, WTIC, WJAR, WCSH, WLIT, WRC, WGY, WBEN, WCAE, WWJ, WMAQ, WDAF.
- 8:45—**PHIL COOK AND INGRAM SHAWERS.** Sponsor: Bristol-Myers Co., NBC. WJZ, WBZ, WBZA, WJR, WBAL, KDKA, WGAR, WCKY, WMAL, WLS, WSYR, KWK, KWCR, WREN, KSO, KOIL.
- 9:00—**A. & P. GYPSIES.** Sponsor: Great Atlantic & Pacific Tea Co. NBC. WFAF, WIIIC, WTAG, WEEI, WJAR, WCSH, WLIT, WRC, WGY, WBEN, WCAE, WTAM, WWJ, WSAI, WMAQ, KSD, WOC, WHO, WOW, WDAF.
- 9:00—**SINCLAIR GREATER MINSTRELS.** Sponsor: Sinclair Refining Co. NBC. WJZ, WBZ, WBZA, WHAM, KDKA, WGAR, WSB, WLS, KWK, WREN, WTMJ, WBAL, KSTP, WEEB, WDAY, KFYR, WRVA, WWNC, WIS, WJAX, WIOD, WMC, WSM, WFLA, WSMB, WJDX, WFAA, WLW, KPRC, WOAI, KTBS, WKY, KOIL, KWCR, KSO, WIBA, WAPI, WPTF, KOA.
- 9:15—**THE STREET SINGER.** Sponsor: Non-Spi Co. CBS. WABC, WADC, WOKO, WCAO, WNAC, WKBW, WGN, WKRC, WHK, CKOK, WDRC, WFBM, KMBC, WHAS, WCAU, WJAS, WEAN, KMOX, WFBL, WSPD, WJSV, KERN, KMIJ, KHJ, KOIN, KFBB, KGB, KFRC, KDB, KOL, KFYP, KWG, KVI, WBT, KRLD, KLZ, KSL.
- 9:30—**AN EVENING IN PARIS.** Sponsor: Bourjois, Inc. CBS. WABC, WCAO, WNAC, WGN, WHK, CKOK, KMBC, WCAU, WJAS, WEAN, WJSV, KLZ, WCCO, KOMA, KSL.
- 9:30—**JACK FROST MELODY MOMENTS.** Sponsor: National Sugar Refining Co. NBC. WJZ, WBAL, WHAM, KDKA, WGAR, WLW, WJR, WENR.
- 9:30—**THE WITCH'S TALE.** Drama and music. WOR.
- 10:00—**CONTENTED PROGRAM.** Sponsor: Carnation Milk Co. NBC. WGY, WBEN, WCAE, WTAM, WENR, WOC, WHO, WDAF, WTMJ, WWJ, KSD, WLW.
- 10:30—**EDWIN C. HILL—"Human Side of the News."** CBS. WABC, WADC, WOKO, WCAO, WAAB, WKBW, WHK, CKOK, WOWO, WDRC, WFBM, WHAS, WJAS, WEAN, WFBL, WSPD, WJSV, WQAM, WDBO, WDAE, WGST, WPG, WLBZ,

- WBRC, WICC, WBT, WDOD, KVOR, WCAH, KRLD, KLZ, WLBW, WBIG, WHP, KTRH, KLRA, WFEA, WCCO, WODX, WLAC, WDSU, WMBD, WMBG, WDBJ, WHEC, KSL, K TSA, WTCC, WIBW, CFRB, WACO, KFH, WSJS, IWORC.
- 10:45—**HOWARD BARLOW'S SYMPHONY ORCHESTRA.** CBS. WABC, WADC, WOKO, WCAO, WAAB, WGR, CKOK, WOWO, WDRC, WFBM, KMBC, WHAS, WJAS, WEAN, WFBL, WSPD, WJSV, WQAM, WDBO, WDAE, WGST, WPG, WLBZ, WBRC, WICC, WBT, WDOD, KVOR, WCAH, KLZ, WLBW, WBIG, WHP, KTRH, KFAB, KLRA, WFEA, WRBC, WCCO, WODX, WLAC, WDSU, WMBD, WMBG, WDBJ, KSL, K TSA, WTCC, WSBT, WIBW, CFRB, WACO, KFH, WSJS, WORC, WIP, WHEC.

TUESDAYS

- 5:45—**LITTLE ORPHAN ANNIE.** Drama. Sponsor: Wander Co. NBC. WJZ, WBAL, WBZ, WBZA, KDKA, CRCT, CFCF.
- 6:45—**JAMES MELTON.** Songs. NBC. WFAF, WTAG, WMAQ, KDYL, KPO, WWJ, WCKY, WWNC, WIS, WSAI, KSD, WOC, WHO, WOW, KOA, WJAR, WSM, WFBR, WJDX.
- 6:45—**LOWELL THOMAS.** News. Sponsor: Sun Oil Co. NBC. WJZ, WBZ, WBZA, CRCT, WJR, WBAL, KDKA, WGAR, WHAM, WLW, WSYR.
- 7:00—**AMOS 'N' ANDY.** Drama. Sponsor: Pepsodent Co. NBC. WJZ, WBAL, WBZ, WBZA, KDKA, WLW, WMAL, CRCT, WIOD, WFLA, WRVA, WGAR, WPTF. Also, 11:00—WMAQ, KDYL, WDAF, KOIL, WTMJ, KSTP, WSM, WMC, WSB, WSMB, KTHS, KPRC, WOAI, WKY, KOA, WHAM, KGO, KFI, KGW, KOMO, KHQ, WENR, KWK, WJR, WREN, WBAF.
- 7:00—**GYPSY NINA.** Songs. CBS. WABC, WADC, WOKO, WCAO, WNAC, WGR, WHK, CKOK, WOWO, WDRC, WHAS, WCAU, WJAS, WEAN, WFBL, WSPD, WQAM, WDBO, WDAE, WGST, WLBZ, WBRC, WICC, WBT, WDOD, KVOR, WCAH, KLZ, WTAQ, WLBW, WBIG, WHP, KTRH, KFAB, KLRA, WFEA, WRBC, WISN, WCCO, WODX, WSFA, WLAC, WDSU, WMBG, WDBJ, WHEC, KSL, K TSA, WTCC, CFRB, WACO, WMT, WVVVA, KFH, WSJS.
- 7:00—**THE KINGS MEN.** Freddy Berrens and Orchestra. Vocal soloists and male quartet. Sponsor: Kings Brewing, Inc. WOR.
- 7:45—**THE GOLDBERGS.** Drama. Sponsor: Pepsodent Co. NBC. WFAF, WTAG, WEEI, WJAR, WPI, WRC, WGY, WBEN, WCAE, WTAM, WWJ, WCSH, WFER, WSAI, WENR, WOW, WDAF.
- 7:45—**BOAKE CARTER.** News. Sponsor: Philco Radio & Television. CBS. WABC, WCAO, WNAC, WGR, WBBM, WHK, CKOK, WCAU, WJAS, WJSV, WBT.
- 8:00—**BLACKSTONE PLANTATION, JULIA SANDERSON AND FRANK CRUMIT.** Sponsor: Waitt & Bond Co., NBC. WFAF, WTAG, WEEI, WJAR, WCSH, WFI, WRC, WGY, WBEN, WCAE, WTAM, WWJ.

8:00—ENO CRIME CLUES. Drama. Sponsor: Harold F. Ritchie & Co. NBC. WJZ, WBZ, WBA, KDKA, WHAM, WGAR, WBAL, WMAQ, KWK, WREN, WLW, WMAL, WJR.

8:30—WAYNE KING'S ORCHESTRA. Sponsor: Lady Esther. NBC. WBAF, WTAG, WCAE, WTMJ, WEEL, WBEW, WJAR, WFL, WRC, WGY, WTAM, WCSH, WWJ, WSAI, KSD, WOC, WHO, WOW, KSTP, WMAQ, WDAF.

8:30—KATE SMITH LA PALINA PROGRAM. Sponsor: Congress Cigar Co. CBS. WABC, WHAS, WJSV, WADC, WKRC, WCAU, WHEC, WMT, WOKO, WHK, WCAO, CKOK, WWO, WJAS, WISN, KMOX, WGR, WFBM, WFBL, WCCO, WKBN, WGN, KMBC, WSPD.

9:00—BEN BERNIE'S BLUE RIBBON ORCHESTRA. Sponsor: Premier Pabst Sales Co. NBC. WBAF, WRVA, WBAP, WTAG, WEEL, WJAR, WCSH, KOA, KSD, WRC, WFBR, WFL, WGY, WBEW, WTAM, WCAE, WLS, WSAI, WWJ, WOC, WHO, WOW, KSTP, WDAY, KFYZ, WCKY, WSM, WMC, WSMB, WKY, WOAI, KPRC, WTMJ.

9:15—FRAY AND BRAGGIOTTI. Piano team. CBS. WABC, WADC, WOKO, WCAO, WNAC, WKBW, CKOK, WDRC, WFBM, KMBC, WHAS, WCAU, WJAS, WEAN, WSPD, WJSV, WQAM, WDBO, WDAE, WGST, WLBZ, WBR, WICC, WBT, WDOD, KVOR, WCAH, KRLD, KLZ, WTAQ, WLBW, WBIG, WHP, KLRA, WFEA, WREC, WISN, WSPA, WLAC, WDSU, KOMA, WMBG, WDBJ, WHEC, KSL, KTS, WTCO, WSBT, WIBW, CFRB, WACO, WMT, WWVA, KFH, WSJS, WORC.

9:30—TEXACO PROGRAM. Sponsor: Texas Co. NBC. WBAF, WCSH, WFL, WJDN, WFBR, WRC, WGY, WBEW, WEEL, WJAR, WCAE, WTAM, WWJ, WTAG, WTMJ, WMAQ, KSD, WOW, WHO, WOC, WLW, WDAF, WIBA, KSTP, WEEC, WDAY, KFYZ, WFLA, WRVA, WVNC, KFSD, WIS, WJAX, WIOD, KVOO, WMC, WSB, WKY, WOAI, KOA, KGIR, KGH, KTAR, KTBS, KGO, KFI, KGW, KOMO, KHQ, WSMB, WBAP, KPRC, KDYL, WSM, WPTF.

9:30—NINO MARTINI. Songs. Music by Howard Barlow's Columbia Symphony Orchestra. CBS. WABC, WADC, WOKO, WCAO, WNAC, WKBW, WHK, CKOK, WWO, WDRC, WFBM, KMBC, WHAS, WJAS, WEAN, WFBL, WSPD, WJSV, WQAM, WDBO, WDAE, WGST, WPG, WLBZ, WBR, WICC, WBT, WDOD, KVOR, WCAH, KRLD, KLZ, WTAQ, WLBW, WBIG, WHP, KTRH, KFAB, KLRA, WFEA, WREC, WISN, WCCO, WODX, WLAC, WDSU, KOMA, WMBG, WDBJ, WHEC, KSL, KTS, WTCO, WIBW, CFRB, WACO, WMT, KFH, WSJS, WORC, WIP.

10:30—LIVES AT STAKE. Male Trio and Orchestra. Sponsor: General Tire & Rubber Co. NBC. WBAF, WCSH, WFL, WFBR, WRC, WGY, WBEW, WTAM, WWJ, WENR, WCAE, KSD, WOC, WTAG, WHO, WSB, WMC, WJDX, WEEL, WSMB, WKY, WBAP, KPRC, KTBS, KOA, KTHS, WOAI, KDYL, KGO, KFI, KGW, WJAR, KOMO, KHQ, WDAF, KVOO, WEEL, WLW, WOW, WRVA, WSM.

10:00—HOUSEHOLD MUSICAL MEMORIES. Sponsor: Household Finance Corp. NBC. WJZ, WBZ, WBA, WBAL, WHAM, KDKA, WJR, WREN, KSO, WSYR, KWK.

10:45—LIGHT OPERA GEMS. Channon Collinge, conductor. CBS. WABC, WADC, WOKO, WCAO, WAAE, WKBW, CKOK, WWO, WDRC, WFBM, KMBC, WHAS, WJAS, WEAN, WFBL, WSPD, WJSV, WQAM, WDBO, WDAE, WGST, WPG, WLBZ, WBR, WICC, WBT, WDOD, KVOR, KLZ, WLBW, WBIG, WHP, KTRH, KFAB, KLRA, WFEA, WREC, WISN, WCCO, WODX, WLAC, WDSU, KOMA, WMBG, WDBJ, WHEC, KSL, WTCO, WSBT, WIBW, CFRB, WACO, WMT, KFH, WSJS, WORC, WIP.

WEDNESDAYS

5:45—LITTLE ORPHAN ANNIE. Drama. Sponsor: Wander Co. NBC. WJZ, WBAL, WBZ, WBA, KDKA, CRCT, CFCE.

6:00—MEET THE ARTIST. Interview by Bob Taplinger. CBS. WABC, WADC, WOKO, WCAO, WAAE, WBBM, WHK, CKOK, WDRC, KMBC, WHAS, WJAS, WFBM, WSPD, WQAM, WDBO, WDAE, WGST, WLBZ, WBR, WICC, WBT, WDOD, KVOR, WCAH, KRLD, KLZ, WTAQ, WLBW, WBIG, WHP, KTRH, KFAB, KLRA, WFEA, WREC, WISN, WCCO, WODX, WSEA, WLAC, WDSU, WJAR, KOMA, WMBG, WDBJ, KSL, KTS, WTCO, WSBT, WIBW, CFRB, WMT, WWVA, KFH, WSJS, WORC, WIP.

6:30—BACK OF THE NEWS IN WASHINGTON. Comment by William Hard. NBC. WBAF, WFBR, WOAI, KTBS, WMAQ, WDAF, WJAR, KTHS, KOA, KFYZ, WIS, WJDX, WVNC, WIBA, KVOO, WDAY, WSM, WSB, KPRC, KGH, WRC, WOC, WHO, KGIR, KPO, WTAM, WWJ.

6:30—HAPPY WONDER BAKERS. Sponsor: Continental Baking Co. CBS. WABC, WAAE, WKBW, WDRC, WHEC, WORC, WMAS.

6:45—LOWELL THOMAS. News. Sponsor: Sun Oil Co. NBC. WJZ, WBZ, WBA, KDKA, WGAR, WHAM, WSYR, WLW, CRCT, WBA, WJR.

7:00—AMOS 'N' ANDY. Drama. Sponsor: Pepsodent Co. NBC. WJZ, WBA, WBZ, WBA, KDKA, WLW, CRCT, WMAL, WRVA, WPTF, WIOD, WGAR, WFLA. Also, 11:00—WMAQ, WENR, KWK, WREN, WDAF, KOIL, WTMJ, KSTP, WSM, WMC, WSB, KTHS, WSMB, WFAA, KPRC, WOAI, WKY, KOA, KGO, KGW, KFI, KDYL, KOMO, KHQ, WHAJ, WCKY, WJR.

7:45—THE GOLDBERGS. Drama. Sponsor: Pepsodent Co. NBC. WBAF, WTAG, WSAI, WEEL, WJAR, WCSH, WFBR, WLT, WRC, WGY, WBEW, WCAE, WTAM, WWJ, WENR, WOW, WDAF.

7:45—BOAKE CARTER. News. Sponsor: Philco Radio & Television. CBS. WABC, WCAO, WNAC, WGR, WBBM, WHK, CKOK, WCAU, WJAS, WJSV, WBT.

8:00—FANNY BRICE AND GEORGE OLSEN'S ORCHESTRA. Sponsor: Standard Brands, Inc. NBC. WBAF, WTIC, WTAG, WEEL, WJAR, WCSH, WLT, WFBR, WRC, WGY, WBEW, WCAE, WTAM, WWJ, WSAI, WLS, KSD, WOW, WDAF, WOC, WHO, WCKY, CFCE, CRCT.

8:00—ENO CRIME CLUES. Drama. Sponsor: Harold F. Ritchie Co. NBC. WJZ, WBA, WBZ, WMAQ, WLW, KWK, WREN, WMAL, WBA, KDKA, WHAM, WGAR, WJR.

8:30—POTASH AND PERLMUTER. Drama. Sponsor: Health Products Co. NBC. WJZ, WBA, WMAL, WHAM, WGAR, KDKA, WCKY, WLS.

8:30—KATE SMITH LA PALINA PROGRAM. Sponsor: Congress Cigar Co. CBS. WABC, WADC, WOKO, WCAO, WGR, WGN, WKRC, WHK, CKOK, WWO, WFBM, KMBC, WHAS, WCAU, WJAS, KMOX, WFBL, WSPD, WJSV, WISN, WCCO, WHEC, WMT.

8:45—PHIL COOK AND HIS INGRAM SHAVERS. Sponsor: Bristol-Myers Co. NBC. WJZ, WBZ, WBA, WJR, WBA, WHAM, WMAL, WLS, WSYR, KWK, KWCR, KOIL, WREN, KSO, KDKA, WGAR, WCKY.

8:45—ABE LYMAN'S ORCHESTRA AND IRVING KAUFMAN. Sponsor: Sterling Products Co., Inc. CBS. WABC, WADC, WOKO, WCAO, WNAC, WGR, WGN, WKRC, WHK, CKOK, WDRC, WFBM, KMBC, WHAS, WCAU, WJAS, WEAN, KMOX, WFBL, WSPD, WJSV, WCCO.

9:00—IRVIN S. COBB. Humorist. Sponsor: Gulf Refining Co. CBS. WABC, WADC, WOKO, WCAO, WNAC, WKBW, WGN, WKRC, WHK, CKOK, WDRC, WFBM, KMBC, WHAS, WCAU, WJAS, WEAN, KMOX, WFBL, WSPD, WJSV, KERN, KMJ, KHJ, KOIN, KFBK, KGB, KFRC, KDB, KOL, KFPY, KWG, KVI, WBT, KRLD, KLZ, KSL.

9:30—WHITE OWL PROGRAM. Burns and Allen; Guy Lombardo's Orchestra. Sponsor: General Cigar Co. CBS. WABC, WADC, WOKO, WCAO, WNAC, WKBW, WGN, WKRC, WHK, CKOK, WDRC, WFBM, KMBC, WHAS, WCAU, WJAS, WEAN, WSM, WJAX, WFLA, WMC, WAPI, WJDX, WJAR, WRVA, WSMB, WOAI, WKY, KOA, KFI, KGO, KGW, KOMO, WBAP (WTMJ on 8:30) (KTHS off 8:30) WPTF, KVOO, WLW, WSB, KTAR, KFYZ, KHQ, KPRC.

10:00—CORN COB PIPE CLUB. Sponsor: Larus & Bros. Co. NBC. WBAF, WTIC, WTAG, WCSH, WRC, WFBR, WLT, WGY, WBEW, WTAM, WCAE, WENR, WWJ, WLW, KSD, WOC, WHO, WOW, WDAF, KOA, KGIR, KGH, KGO, KFI, KGW, KOMO, WEEL, WJAR, KHQ, KDYL, WTMJ, WBA, WEEC, WDAY, KFYZ, KSTP, WRVA.

10:00—OLD GOLD PROGRAM. Fred Waring's Pennsylvanians with "Mandy Lou." Sponsor: P. Lorillard Co. CBS. WABC, WADC, WOKO, WCAO, WNAC, WKBW, WGN, WKRC, WHK, CKOK, WWO, WDRC, WFBM, KMBC, WHAS, WCAU, WJAS, WEAN, KMOX, WFBL, WSPD, WJSV, WJAX, WQAM, WDBO, WDAE, WGST, WLBZ, WBR, WICC, WBT, WDOD, KVOR, WCAH, KRLD, KLZ, WLBW, WBIG, WHP, KTRH, KLRA, WFEA, WREC, WISN, WCCO, WODX, WTAQ, WJAR, KOMA, WMBG, WDBJ, KSL, KTS, WTCO, WSBT, WIBW, CFRB, WMT, WWVA, KFH, WSJS, WORC, WIP.

KTSA, WTCO, WIBW, WMT, KFH, WORC, WKBH, KSCJ, WNA.

10:30—EDWIN C. HILL—"Human Side of the News." CBS. WABC, WADC, WOKO, WCAO, WAAE, WKBW, WHK, CKOK, WWO, WDRC, WHAS, WJAS, WEAN, WFBL, WSPD, WJSV, WDBO, WDAE, WGST, WPG, WLBZ, WBR, WICC, WBT, WDOD, KVOR, WCAH, KLZ, WLBW, WBIG, WHP, KTRH, KLRA, WFEA, WREC, WCCO, WODX, WLAC, WDSU, WJAR, WMBG, WMBG, WDBJ, WHEC, KSL, KTS, WTCO, WIBW, CFRB, WACO, WMT, KFH, WSJS, WORC, WIP.

10:45—HOWARD BARLOW'S COLUMBIA SYMPHONY ORCHESTRA. CBS. WABC, WADC, WOKO, WCAO, WAAE, WGR, CKOK, WWO, WDRC, WFBM, KMBC, WHAS, WJAS, WEAN, WFBL, WSPD, WJSV, WDBO, WDAE, WGST, WPG, WLBZ, WBR, WICC, WBT, KTRH, KFAB, KLRA, WFEA, WREC, WCCO, WODX, WLAC, WDSU, WJAR, KOMA, WMBD, WMBG, WDBJ, WHEC, KSL, KTS, WTCO, WSBT, WIBW, CFRB, WACO, WMT, KFH, WSJS, WORC, WIP, WDOD, KVOR, KLZ, WLBW, WBIG, WHP.

11:15—LITTLE JACK LITTLE. Vocalist & pianist. CBS. WABC, WADC, WOKO, WCAO, WNAC, WGR, CKOK, WWO, WDRC, WFBM, KMBC, WHAS, WJAS, WEAN, WSPD, WJSV, WQAM, WDBO, WDAE, WGST, WPG, WLBZ, WBR, WICC, WBT, WDOD, KVOR, WCAH, KLZ, WLBW, WBIG, WHP, KTRH, KFAB, KLRA, WFEA, WCCO, WODX, WLAC, WDSU, WJAR, KOMA, WMBD, WMBG, WDBJ, WHEC, WSL, KTS, WTCO, WSBT, WIBW, CFRB, WACO, WMT, WSJS, WORC, WIP.

THURSDAYS

5:45—LITTLE ORPHAN ANNIE. Drama. Sponsor: Wander Co. NBC. WJZ, WBA, WBZ, WBA, CFCE, KDKA, CRCT.

6:45—LOWELL THOMAS. News. Sponsor: Sun Oil Co. NBC. WJZ, WBA, WBZ, WBA, WJR, WSYR, KDKA, WGAR, WLW, WHAM, CRCT.

7:00—AMOS 'N' ANDY. Drama. Sponsor: Pepsodent Co. NBC. WJZ, WBA, WBZ, WBA, KDKA, WLW, WMAL, CRCT, WRVA, WPTF, WIOD, WFLA, WGAR. Also, 11:00—WMAQ, WENR, KWK, WREN, WDAF, KOIL, WTMJ, KTHS, WBAF, KPRC, WOAI, WKY, KOA, KDYL, KGO, KFI, KGW, KOMO, KHQ, WSMB, KSTP, WSM, WMC, WSB, WHAM, WCKY, WJR.

7:15—COUNTESS OLGA ALBANI. Songs. NBC. WBAF, WJAR, WMAQ, WDAF, WOC, WHO, WIS, KGO, KDYL, WSAI, WIBA, WKY, KTBS, WOAI, KOA, KOMO, WCKY, KSD, WJDN, WTAG, WCSH, WBEW, WFL, WAPI, WSMB, KVOO.

7:45—THE GOLDBERGS. Drama. Sponsor: Pepsodent Co. NBC. WBAF, WTAG, WEEL, WJAR, WCSH, WFL, WFBR, WRC, WGY, WBEW, WCAE, WTAM, WWJ, WSAI, WENR, WOW, WDAF.

7:45—BOAKE CARTER. News. Sponsor: Philco Radio & Television. CBS. WABC, WCAO, WNAC, WGR, WBBM, WHK, CKOK, WCAU, WJAS, WJSV, WBT.

8:00—FLEISCHMANN HOUR—RUDY VALLEE AND GUEST STARS. Sponsor: Standard Brands, Inc. NBC. WBAF, WTAG, WEEL, WCSH, WFL, WFBR, WRC, WGY, WBEW, WCAE, WTAM, WWJ, WMAQ, KSD, WOC, KDYL, WDAF, WHO, WOW, CRCT, CFCE, KSTP, WEEC, WDAY, WSM, WIOD, WJAX, WFLA, WMC, WAPI, WJDX, WJAR, WRVA, WSMB, WOAI, WKY, KOA, KFI, KGO, KGW, KOMO, WBAP (WTMJ on 8:30) (KTHS off 8:30) WPTF, KVOO, WLW, WSB, KTAR, KFYZ, KHQ, KPRC.

9:00—CAPTAIN HENRY'S MAXWELL HOUSE SHOW BOAT. Charles Wininger, Lanny Ross, Annette Hanshaw, others. Sponsor: General Foods Corp. NBC. WBAF, WTAG, WEEL, WJAR, WCSH, WFL, WFBR, WRC, WGY, WBEW, WCAE, WTAM, WWJ, WSAI, WMAQ, KSD, WOC, WHO, WOW, WDAF, WTMJ, WRVA, WVNC, WIS, WJAX, WIOD, WFLA, WJDX, WMC, WSB, WAPI, WSMB, KTBS, WKY, KPRC, WOAI, WSM, WBAP, WCKY, KTSF. Also 1 A. M., Friday—KOA, KDYL, KGO, KFI, KGW, KOMO, KHQ, KFSD, KTAR.

9:30—WAYNE KING'S ORCHESTRA. Sponsor: Lady Esther. NBC. WJZ, WBA, WBZ, WBA, KDKA, KSO, KWK, KWCR, KOIL, WENR, WREN, WGAR, WJR, WHAM.

11:00—JAMES MELTON. Songs. NBC. WBAF, WFBR, WWJ, WSAI, WCAE, WOW, WVNC, WIS, WFLA, WFL, WOC, WHO, CRCT.

FRIDAYS

5:30—WINNIE THE POOH. Children's drama. NBC. WEAJ, WTAG, WBEI, WJAR, WFBR, WRC, WGY, WBNB, WWJ, WTAM, WSAI, WMAQ, WOC, WIS, WDAF, CFCE, WJBA, KHQ, WAPI, KSTP, WDAY, WSM, WSB, WMC, WSMB, WKY, KTBS, WOAI, KOA, KDYL, KGO, KOMO, WBCB, WJDX, WCKY, WWNC, WIOD, WCHS, CRCT, WFAA, KPRC, KSD, KVOO.

5:45—LITTLE ORPHAN ANNIE. Drama. Sponsor: Wander Co. NBC. WJZ, WBAL, WBZ, WBZA, KDKA, CRCT, CFCE.

6:45—LOWELL THOMAS. News. Sponsor: Sun Oil Co. NBC. WJZ, WLW, WHAM, CRCT, WSYR, WGAR, WBZ, WBZA, KDKA, WBAL, WJR.

7:00—AMOS 'N' ANDY. Drama. Sponsor: Pepsodent Co. NBC. WJZ, WRZ, WBZA, WBAL, KDKA, WLW, CRCT, WRVA, WPTF, WMAL, WFLA, WIOD, WGAR. Also, 11:00—WMAQ, WENR, KWK, WREN, WDAF, KOIL, WTMJ, KSTP, WSM, WMC, WSB, WSMR, WHAM, KTHS, WFAA, KPRC, WOAI, KHQ, WKY, KOA, KGO, KFI, KGW, KOMO, KDYL, WJR, WCKY.

7:45—THE GOLDBERGS. Drama. Sponsor: Pepsodent Co. NBC. WEAJ, WTAG, WENR, WOV, WEEI, WJAR, WCHS, WLIT, WRC, WGY, WBNB, WCAE, WTAM, WWJ, WSAI, WDAF, WFBR.

7:45—BOAKE CARTER. News. Sponsor: Philco Radio & Television. CBS. WABC, WCAO, WNAC, WGR, WBBM, WHK, CKOK, WCAU, WJAS, WJSV, WBT.

8:00—JESSICA DRAGONETTE AND THE CAVALIERS. Sponsor: Cities Service Co. NBC. WEAJ, WTAG, WBEI, WCHS, WCAE, WLIT, WFBR, WRC (WGY off 8:30) WDAF, WBNB, WTAG, WOAI, WTAM, WWJ, WSAI, KYW, KSD, KTHS, WOC, WHO, WOV, KOA, KPRC, KTBS, WTMJ (8:30) WBEI, WKY, WFAA, WEEI, KDYL, WJAR, KVOO.

8:00—NINO MARTINI. Songs. Accompanied by Howard Barlow's Symphony Orchestra. CBS. WABC, WADC, WOKO, WCAO, WAAB, WGR, WHK, CKOK, WOV, WDR, WFBM, WCAU, WJAS, WEAN, WFBL, WSPD, WJSV, WQAM, WDBO, WGST, WLBZ, WBR, WICC, WBT, WODD, KVOR, WCAH, WTAQ, WLBW, WBIG, WHP, KTRH, KFAB, KLRA, WFEA, WREC, WISN, WCCO, WODX, WSPA, WLAC, WDSU, WTAR, KOMA, WMG, WDBJ, WHEC, KSL, KTSA, WSBT, CFRB, WACO, WVA, WSJS, WORC, KMBC.

8:15—KING ARTHUR AND ARABIAN KNIGHTS. Don Voorhees Orchestra and soloists. Sponsor: Pioneer Ice Cream. WOR.

8:45—PHIL COOK AND HIS INGRAM SHAVERS. Sponsor: Bristol Myers Co. NBC. WJZ, WBAL, WBZ, WBZA, WHAM, KDKA, WCKY, WLS, WMAL, WSYR, KWCR, KWK, WREN, KOIL, KSO, WJR.

9:00—BEST FOODS MUSICAL GROCERY STORE. Tom Howard, Jeannie Lang, others. Sponsor: Best Foods, Inc. NBC. WEAJ, WTAG, WBEI, WJAR, WCHS, WGY, WBNB, KSD, WTAM, WWJ, WRC, WFBR, WLIT, WMAQ, WLW. Also, 11:30—KOA, KGO, KGW, KHQ, KOMO, KDYL, KFI, KFSD, KTAR, WDAF.

9:00—IRVIN S. COBB. Humorist. Sponsor: Gulf Refining Co. CBS. WABC, WADC, WOKO, WCAO, WNAC, WKBW, WKRC, WHK, CKOK, WOV, WDR, WHAS, WCAU, WJAS, WEAN, WFBL, WSPD, WJSV, WQAM, WDBO, WDAE, WGST, WLBZ, WBR, WBT, WODD, WCAH, KRLD, WBIG, KTRH, KLRA, WFEA, WREC, WSPA, WLAC, WDSU, WTAR, WMBG, WDBJ, KTSA, WTCO, WORC, WMAS.

9:30—POND'S PROGRAM. Comedy and Songs. Sponsor: Lamont, Corliss & Co. NBC. WEAJ, WDAF, WWJ, WTAG, WJAR, WCHS, WLIT, WFBR, WRC, WGY, WBNB, WCAE, WTAM, WSAI, WENR, KSD, WOC, WHO, WOV.

9:30—PHIL BAKER. Variety. Sponsor: Armour & Co. NBC. WJZ, WBAL, WBZ, WBZA, KGW, KOMO, KHQ, WHAM, KDKA, WGAR, WJR, WMAQ, KWK, WREN, KOIL, WTMJ, KSTP, WBCB, WRVA, WWNC, WJAX, WIOD, WSM, WMC, WSE, WAPI, WSMR, WFAA, KPRC, WOAI, WKY, KOA, KGO, KFI, KDYL, KSO.

9:30—ANDRE KOSTELANETZ PRESENTS. Orchestra and vocalists. CBS. WABC, WADC, WOKO, WCAO, WNAC, WKBW, WHK, CKOK, WOV, WDR, WFBM, KMBC, WJSV, WQAM, WDBO, WGST, WLBZ, WBR, WHAS, WCAU, WJAS, WEAN, WSPD, WBT, WODD, KVOR, WCAH, KRLD, KLZ, WTAQ, WLBW, WBIG, WHP, KTRH, KLRA, WFEA, WISN, WCCO, WODX, WSPA, WLAC, WDSU, WTAR, KOMA, WMBG, WDBJ.

WHEC, KSL, KTSA, WSBT, WIBW, CFRB, WACO, KFH, WSJS, WORC.

10:00—THE FIRST NIGHTER. Drama. Sponsor: Campana Corp. NBC. WJZ, WBZA, WBAL, WBZ, WHAM, KDKA, WGAR, WCKY, KWK, WREN, WENR, KOIL, KSTP, WBEBC, KOA, KDYL, WSB, KGO, KFI, KGW, KOMO, KHQ, KTBS, WKY, WTMJ, WSMB, WJR, WSM, WAPI, KPRC, WOAI.

10:00—CHESTERFIELD PROGRAM. Lou Holtz, Grace Moore, Leonard Hayton's Orchestra. CBS. WABC, WADC, WOKO, WCAO, WNAC, WKBW, WGN, WKRC, WHK, WOV, WDR, WFBM, KMBC, WHAS, WCAU, WJAS, WEAN, KMOM, WFBL, WSPD, WJSV, WQAM, WDBO, WDAE, KERN, KMJ, KHJ, KOIN, KFBE, KGB, KFRC, KDB, KOL, KFPY, KGW, KVI, WGST, WPG, WLBZ, WBR, WBT, WCAH, KRLD, KLZ, KTRH, KLRA, WREC, WISN, WCCO, WLAC, WDSU, WTAR, KOMA, KOH, WMBG, WDBJ, WHEC, KSL, KTSA, WTCO, WMT, KFH, WORC, WXYZ.

10:00—U. S. NAVY BAND. NBC. WEAJ, WTAG, WTAG, KFYR, WPTF, WAPI, WLIT, WFBR, WRC, WGY, WBNB, WWJ, WCAE, WTAM, WENR, KSD, WOC, WHO, WOV, WDAF, WTMJ, WIS, WJBA, KSTP, WRVA, WWNC, WIOD, WFLA, WSM, WMC, WSB, WJDX, WSMB, KTBS, WKY, WFAA, KPRC, WOAI, KOA, WJAX, WLW, KDYL, KGIR, KGHL, KGO, KFI, KGW, KOMO, KHQ, KFSD, KTAR, WCHS, WEEI, WJAR, WBEBC, WDAY.

10:30—EDWIN C. HILL—"Human Side of the News." CBS. WABC, WADC, WOKO, WCAO, WAAB, WKBW, CKOK, WOV, WDR, KMBC, WCAU, WJAS, WEAN, WSPD, WJSV, WQAM, WDBO, WDAE, WGST, WLBZ, WBR, WICC, WBT, WODD, KVOR, WCAH, KLZ, WLBW, WBIG, WHP, KTRH, KLRA, WFEA, WREC, WCCO, WODX, WLAC, WDSU, WTAR, WMBD, WMBG, WDBJ, WHEC, KSL, KTSA, WSBT, WIBW, CFRB, WACO, WMT, KFH, WSJS, WORC.

SATURDAYS

2:30—SAVIT STRING QUARTETTE. CBS. WABC, WADC, WOKO, WCAO, WNAC, WGR, WBBM, WHK, CKOK, WOV, WDR, WFBM, WHAS, WCAU, WJAS, WEAN, WFBL, WSPD, WJSV, WQAM, WDBO, WDAE, WGST, WPG, WLBZ, WBR, WICC, WBT, WODD, KVOR, WCAH, KLZ, WTAQ, WLBW, WBIG, WHP, KTRH, KFAB, KLRA, WFEA, WISN, WCCO, WODX, WSPA, WLAC, WDSU, WTAR, KOMA, WMBG, WDBJ, WHEC, KSL, KTSA, WTCO, WSBT, WACO, WVA, KFH, WSJS, WORC.

4:00—WEEK-END REVUE. Variety. NBC. WEAJ, WTAG, WEEI, WJAR, WFBR, WRC, WGY, WTAM, WWJ, WMAQ, WSAI, WCAE, WDAF, WBNB, KSD, (WOV, WLIT on 4:30) WCHS, WOC, WHO.

5:45—LITTLE ORPHAN ANNIE. Drama. Sponsor: Wander Co. NBC. WJZ, WBAL, WBZ, WBZA, KDKA, CRCT, CFCE.

6:00—WEEKENDERS. Frances Langford, Dick Leibert and the Rollickers Quartet. NBC. WEAJ, WTAG, WJAR, WGY, WWJ, WOC, WHO, WRVA, WWNC, WSM, WJAX, WSM, WSB, WMC, WJDX, WSMB, KOA, KDYL, KPO, (WFBR, WTAM, WDAF, WFLA off 6:45) WFI, WRC, WSAI, WCAE, KSD, WAPI on 6:45).

7:00—POLITICAL SITUATION IN WASHINGTON TONIGHT. Frederic William Wile. CBS. WABC, WADC, WOKO, WCAO, WNAC, WGR, WBBM, WOV, WDR, KMBC, WHAS, WCAU, WJAS, WEAN, WFBL, WSPD, WJSV, WQAM, WDBO, WDAE, WGST, WLBZ, WBR, WICC, WBT, WODD, KVOR, WCAH, KLZ, WTAQ, WLBW, WBIG, WHP, KTRH, KFAB, KLRA, WFEA, WREC, WISN, WCCO, WODX, WSPA, WLAC, WDSU, WTAR, WMBG, WDBJ, WHEC, KSL, KTSA, WTCO, WIBW, WACO, WMT, KFH, WVA, WSJS.

9:00—FERDE GROFE'S ORCHESTRA WITH CONRAD THIBAUT. Sponsor: Philip Morris & Co. NBC. WEAJ, WMAQ, WWJ, WEEI, WJAR, WCHS, WRC, WFI, WTAM, WCAE, KSD, WDAF, WGY, WBNB.

10:00—SATURDAY NIGHT DANCING PARTY. B. A. Rolfe's Orchestra. Sponsor: Hudson Motor Car Co. NBC. WEAJ, WEEI, WJAR, WTAG, WCHS, WFI, WFBR, WGY, WBNB, WTAM, WCAE, WWJ, WLW, WMAQ, KSD, WOC, WHO, WOV, WDAF, WRC, CKGW, CFCE, KSTP, WSE, WSMB, WBAP, KOA, KDYL, KGO, KFI, WTMJ.

10:45—GERTRUDE NIESEN. Songs. Accompanied by Freddie Rich's Orchestra. CBS. WABC, WADC, WOKO, WCAO, WAAB, WKBW, CKOK, WDR, WFBM, KMBC, WHAS, WCAU, WJAS, WEAN, WSPD,

WJSV, WQAM, WDBO, WDAE, WGST, WPG, WLBZ, WBR, WICC, WBT, WODD, KVOR, WCAH, KLZ, WLBW, WBIG, WHP, KTRH, KLRA, WFEA, WREC, WCCO, WODX, WLAC, WDSU, WTAR, KOMA, WMBD, WMBG, WDBJ, WHEC, KSL, KTSA, WTCO, WIBW, CFRB, WACO, WMT, WVA, KFH, WSJS, WORC.

SUNDAYS

11:00 A. M.—HORN & HARDART HOUR. Juvenile entertainers. Sponsor: Horn & Hardart Co. CBS. WABC.

11:15 A. M.—MAJOR BOWEN'S CAPITOL FAMILY. Variety. NBC. WEAJ, WJAR, WFBR, WRC, WTAM, WDAF, WFLA, KFYR, (WAPI, WHO, WOC off 11:45) WSMB, WTAG, KDYL, WBEBC, WJAX, WFAA, WGY, WDAY, WSAI, KSTP, WMC, WIOD, WKY, KTBS, WOAI, WMAQ, WWNC, KPRC, KOA, WCAE, KVOO.

11:45 A. M.—SALT LAKE TABERNACLE CHOIR AND ORGAN. CBS. WABC, WADC, WOKO, WCAO, WNAC, WGR, CKOK, WOV, WDR, KMBC, WHAS, WCAU, WEAN, WFBL, WSPD, WJSV, WQAM, WDBO, WDAE, WGST, WPG, WLBZ, WBR, WICC, WBT, WODD, KVOR, WCAH, KLZ, WTAQ, WLBW, WBIG, WHP, KTRH, KFAB, KLRA, WFEA, WREC, WCCO, WODX, WLAC, WDSU, KOMA, WMBD, KSL, KTSA, WSBT, WIBW, CFRB, WACO, WMT, WORC.

12:15—RADIO CITY CONCERT. S. L. Rothafel (Roxy), master-of-ceremonies. Variety. NBC. WJZ, WBAL, WHAM, WGAR, WFLA, WLW, KDKA, KWK, WREN, KOIL, WJAX, WIOD, KFSD, WBZ, WBZA, CFCE, WDAY, KFYR, WSMB, KPRC, KOA, KDYL, WMAQ, WAPI, KTAR, KGO, KFI, KGW, KOMO, KHQ, WMAL, WBEBC, WIS, WSM, WSB, WCKY, KSO, CRCT, WBAJ, WOAI.

1:30—SABBATH REVERIES. Dr. Charles L. Goodell. NBC. WJZ, WBAL, WMAL, WSYR, WJR, KWCR, WREN, KOIL, WRVA, WWNC, WIS, WIOD, WBEBC, WDAY, KFYR, WAPI, WSMB, KGIR, WOAI, KOA, KGO, KFI, KGW, KOMO, WBZ, WBZA, WHAM, KSO, KDYL, KGHL, WJAX, WJDX.

3:00—WAYNE KING'S ORCHESTRA. Sponsor: Lady Esther. NBC. WEAJ, WTAG, WEEI, WCHS, WJDX, WLW, WRC, WGY, WBNB, WCAE, WTAM, WWJ, KYW, KSD, WOC, WHO, WOV, WRVA, WTMJ, KSTP, KGW, KHQ, KVOO, KDYL, WKY, WOAI, KPRC, WFAA, KOA, KGO, WLIT, KFI, WJAX, WFLA, WMC, WSMB, KOMO, WWNC, WIOD, WSM, WSB, WJAR.

3:30—THE RADIO PULPIT. Dr. Ralph W. Sockman. NBC. WEAJ, WEEI, KTHS, WTAG, WCHS, WFBR, WRC, WBNB, WOV, WDAF, WLIT, KFYR, KGO, KGW, KHQ, WGY, KDYL, KFSD, WRVA, WJAR, WJDX, WWJ, WWNC, WIS, WJAX, KYW, KOMO, WIOD, WFLA, WSM, WSE, KGIR, KVOO, KPRC, WOAI, WKY, KOA, KGHL, WCAE, WTAM, WSAI, KFI, KTBS, WBEBC.

4:00—CATHEDRAL HOUR. Channon Colinge, conductor. Choir, orchestra and soloists. CBS. WABC, WADC, WOKO, WCAO, WNAC, WGR, WHK, CKOK, WDR, WFBM, KMBC, WHAS, WCAU, WJAS, WEAN, WFBL, WSPD, WJSV, WQAM, WDBO, WDAE, WGST, WLBZ, WBR, WICC, WBT, WODD, KVOR, WCAH, KRLD, KLZ, WTAQ, WLBW, WBIG, WHP, KTRH, KFAB, KLRA, WFEA, WREC, WISN, WCCO, WODX, WDBJ, WHEC, KSL, KTSA, WTCO, WSBT, WIBW, CFRB, WMT, KFH, WSJS, WORC.

5:00—THE WORLD OF RELIGION. Dr. Stanley High. NBC. WJZ, WBAL, WBZ, WREN, WBZA, WGAR, KWK, WSM, WIS, WPTF, WWNC, KWCR, WIOD, WFLA, WSB, KOA, KGHL, KGW, WJDX, WOAI, KTBS, KGO, KHQ, WJR, KFSD, KTAR, KOIL, WJAX, WSMB, WRVA, KGIR, KVOO, WHAM, WMAL, WCKY, WCPL, KSTP, WKY, KPRC, KSO, WBEBC, WSYR, WDAY.

5:30—FRANK CRUMIT AND JULIA SANDERSON. Songs. Sponsor: General Baking Co. CBS. WABC, WADC, WOKO, WCAO, WAAB, WGR, WHK, CKOK, WDR, WFBM, KMBC, WHAS, WCAU, WEAN, KMOM, WFBL, WSPD, WJSV, WICC, WCAH, KFAB, WDSU, WTAR, KOMA, WHEC, WVA, KFH, WORC, WMAS.

6:00—CATHOLIC HOUR. NBC. WEAJ, WTAG, WEEI, WJAR, WCHS, WLIT, WFBR, WRC, WGY, WBNB, WCAE, WTAM, WWJ, WIOD, WBEBC, KFYR, WRVA, WOAI, WSAI, WOC, WHO, WOV, WDAF, WJBA, WFLA, WSM, WMC, WSMB, WKY, KOA, KGHL, WJDX, WBAJ, KPRC, WWNC, KGIR,

KTAR, KPO, WAPI, WJAX, WIS, WSB, KTBS, KDYL, KECA, KGW, KOMO, WENR, KSTP, KVOO.

8:00—CHASE & SANBORN HOUR. Sponsor: Standard Brands, Inc. NBC. WEAJ, WTIC, WTAG, WVEN, WCAE, WTAM, WWJ, WLV, KSD, WOC, WHO, WDAF, CFCE, WSB, WTMJ, KSTP, WEBC, WDAY, CRCT, KFYR, WWNC, WIS, KDYL, KPRC, WKY, WIOD, WFLA, WMC, WJDX, WSMB, KVOO, WFAA, WOAI, KOA, KGO, KHQ, KTAR, WJAR, WCSH, WPTF, WFBR, WRC, WGY, WSM, WOW, KFI, KGW, KOMO, WMAQ, WRVA, WAPI, KTHS, WJAX.

8:30—CHOIR INVISIBLE. Orchestra directed by George Shackley; vocal soloists and poet. WOR.

9:00—MANHATTAN MERRY-GO-ROUND. Orchestra and vocalists. Sponsor: R. L. Watkins Co. NBC. WEAJ, WTIC,

WJAR, WFBR, WRC, WGY, WWJ, WSAI, WENR, KSD, WOC, WHO, WOW, WDAF, KHQ, KOA, KDYL, KGO, KFI, KGW, KOMO, WFI, WTAM, CFCE, CRCT.

9:30—AMERICAN ALBUM OF FAMILIAR MUSIC. Orchestra and vocalists. Sponsor: Bayer Co. NBC. WEAJ, WTAG, WCKY, WJAR, WCSH, WFI, WFBR, WRC, WGY, WVEN, WCAE, WTAM, WWJ, WSAI, WENR, KSD, WOC, WHO, WOW, WIOD, WFLA, WMC, WSE, WOAI, WJDX, WFAA, WKY, KOA, KPRC, KGO, KFI, KGW, KHQ, KOMO, WSMB, KDYL, WRVA, WJAX, WPTF, KSTP, WTMJ, WEEI, WDAF, KVOO, CFCE, CRCT.

10:00—COL. LOUIS McHENRY HOWE. Interview by Walter Trumbull. Sponsor: RCA-Victor Company, RCA-Radiotron Company and Cunningham Radio Tube Company. NBC. WEAJ, WTIC, WTAG,

WJAR, WCSH, WFI, WFBR, WRC, WGY, WVEN, WCAE, WTAM, WWJ, WSAI, WMAQ, KSD, WOC, WHO, WOW, WDAF, WTMJ, WIBA, KSTP, WEBC, WDAY, KFYR, WMC, WSB, WSMB, WKY, WFAA, KPRC, WOAI, KOA, KDYL, KGIR, KGHL, KGO, KFI, KGW, KOMO, KHQ.

10:15—COLUMBIA REVUE. Freddie Rich's Orchestra, chorus and soloists. CBS. WABC, WADC, WOKO, WCAO, WAAB, WKBY, WHK, CKOK, WOWO, WDRC, WFBN, KMBC, WHAS, WCAU, WJAS, WFBL, WSPD, WJVS, WQAM, WDBO, WDAE, WGST, WPG, WLBZ, WBRG, WICC, WBT, WDOD, KVOR, WCAH, KRLD, KLZ, WTAQ, WLBW, WBIG, WHP, KTRH, KLRA, WFEA, WREC, WISN, WCCO, WODX, WLAO, WDSU, KOMA, WMBD, WDEJ, WHEC, KSL, KTSB, WTOC, WIBW, CFRB, WACO, WMT, WSJS, WORC.

Our "Uncle Sam" Says

FREDERIC WILLIAM WILE, CBS political analyst, recently completed his tenth year on the air. He was previously an NBC commentator. . . . A total of twenty-five dance bands studs the CBS summer schedule. . . . The "You and Your Government" series sponsored by the National Advisory Council on Radio in Education, was carried on the NBC right through the Summer. . . . NBC scored a big scoop by lining up the Lewisohn Stadium concerts of the New York Philharmonic-Symphony Orchestra. . . . But CBS, which had the series in previous seasons, immediately announced that it would broadcast the elaborate Robin Hood Dell concerts of the Philadelphia Orchestra. . . . Nino Martini, CBS operatic star, was recently awarded the chain's achievement medal. . . . Mark Warnow has been designated as a staff CBS musical director; his associate directors are Freddie Rich



and Fred Berrens. . . . Fred Waring's Old Gold program is broadcast over some 80 stations each Wednesday; this is the greatest weekly CBS commercial hook-up. . . . No matter how good the announcers are, descriptions of horse-races don't click on the air. . . . Sponsors are reported to be looking for a new

crop of comedians for their Fall programs. . . . The renewed popularity of musical films caused talkie producers to snatch up many radio stars. . . . WMCA won its long court battle against WNYC and now has full-time on the air with its sister station, WPCB; the WMCA-WPCB combine launched the full-time schedule with a gala all-star program broadcast from the stage of the Manhattan Theatre in New York. . . . The Maxwell House Show Boat program is repeated at a late hour each Thursday night for the benefit of listeners in the Far West. . . . Many New York radio stars took up the roller skating fad and bring the skates to the studios. . . . Major Gladstone Murray, a British Broadcasting Corporation executive, was a recent visitor to the U. S. A. and was heard over both the NBC and CBS. . . . The Boswell Sisters have gone to London for stage and night club appearances.

Is Quality Worth While?

(Continued from page 141)

groups of students with the average intelligence ratings of these same groups, we suspect a tendency for the least intelligent groups to prefer the first or second playing even more predominantly than is true of the most intelligent groups. This would confirm the fatigue theory, but the differences are too small to be conclusive.

There is clearly evident in the group comparisons a tendency for the people who believed their ears and reported "no difference" to be concentrated among the more intelligent students. The more intelligent half of the groups, as selected by average scores in intelligence tests, contained 23 of the 28 persons who correctly heard all four playings as alike.

The practical interpretation of tests including no more than 423 people must be approached with much caution. The tech-

nique of preference testing does seem to be exonerated from the charge that the third article to be presented will tend to be preferred. This is true, at least, for the kind of ear test here described. This does not mean, however, that such preference tests necessarily are accurate. On the contrary, it is evident that in any series of four musical instruments presented to people like the students tested, the first and second to be presented would have substantial advantage over the third and fourth.

Whether or not this artificial advantage of first or second place would be outweighed by real differences in quality our experiment does not tell us. It seems probable, however, that the advantage of mere place in the list would overcome a difference in quality, provided this difference is not too great. If 93 percent of a group of presumably average people believe firmly that they hear a difference in musical quality when none exists, it is unlikely that these same people would recognize real but slight differ-

ences sufficiently to make correct decisions.

This feature of our results seems also to support a conclusion for which there is much additional evidence. This is that the average American radio listener is constitutionally incapable of distinguishing perfect musical quality from quality which is reasonably good but not quite perfect. As a radio manufacturer spends more and more effort and money on closer and closer approach to musical perfection, he will encounter, we suspect, the familiar law of diminishing returns. After a certain point in the approach to perfection, effort spent for closer perfection will not be worth while, because the customers cannot distinguish any difference.

Further psychological experiments to decide just what is this point of musical quality, beyond which average American ears and mentalities make it unnecessary to go, I would nominate as the most profitable single activity which the radio industry could undertake.



COLONEL LOUIS MCHENRY HOWE



CONRAD THIBAUT

*Personal interviews
with broadcast ar-
tists and executives*

Backstage in

By Samuel

AN unusual series of vast interest to radio listeners all over the United States was recently launched over the NBC on Sunday nights. The series features Colonel Louis McHenry Howe, secretary of President Roosevelt. Colonel Howe is interviewed by Walter Trumbull, a well-known journalist, upon the developments of the previous week in Congress and general national affairs. Trumbull, in the rôle of a private citizen, interrogates Colonel Howe on administrative matters in which the nation is vitally interested. It was intended to have the questions in the series cover the whole run of affairs in official Washington. This unique series was arranged jointly by the RCA-Victor Company, Inc., and the RCA-Radiotron and Cunningham Radio Tube companies.

It was in one of these serious moments that he decided to earn a name for himself as a radio executive. Out of his plans there emerged a new network known as the Amalgamated Broadcasting System. At this writing, the new radio firm has established New York offices at 501 Madison Avenue—right across the street from the CBS Building. Studios are being constructed and talent auditions are under way. If the plans of the Amalgamated officials proceed smoothly, the chain should already be on the air by the time this item is published. The ABS expected to start operation with the following stations: WCDA, WBNX, WMSG, all of New York; WTNJ, Trenton; WPEN, Philadelphia; WDEL, Wilmington; WCBM, Baltimore, and WOL, Washington. It was planned to combine the three New York out-

lets under single call letters. Many additional stations for the chain were said to be in the offing.

CONRAD THIBAUT, young American baritone, was recently selected as the star of the thrice-weekly Philip Morris program heard over the NBC Mondays, Wednesdays and Saturdays. Thibault is co-featured with Ferde Grofe's Orchestra. The late President Coolidge, a fellow-townsmen of Thibault, encouraged the young baritone to develop his voice. Thibault studied at the Curtis Institute of Music in Philadelphia and under private tutorage. He appeared with the Philadelphia Grand Opera Company and made concert appearances throughout the East. His first radio activities were confined to local Philadelphia stations. Ferde Grofe is equally well known as a conductor, arranger and composer. He was

ED WYNN, the veteran stage comedian who leaped to radio fame as the Fire Chief of the NBC Texaco program, has his serious moments when "out of character."

ED WYNN

ARTHUR TRACY



EDDIE DUCHIN





GRACE MOORE



LOU HOLTZ

Broadcasting

Chatty bits of news on what is happening before the microphone

Kaufman

chief arranger for Paul Whiteman for several years. His compositions include the "Grand Canyon Suite," "Mississippi Suite" and "Tabloid."

ARTHUR TRACY, the CBS Street Singer, recently launched a new commercial series over a coast-to-coast hook-up. His programs are heard Mondays, Wednesdays and Fridays under the sponsorship of the Non-Spi Company. For some time prior to the start of this new series, Tracy had been absent from the air on account of lengthy theatrical bookings. Tracy's rise in radio was sensational. When he came to Columbia two years ago, he was unknown to network audiences. He developed a large following through his efforts on a daytime program and was soon switched to a choice evening spot. He was featured on several commercial programs, including a long en-

ROBERTS BROTHERS



gement on the Chesterfield program. Since his rapid rise in radio, Tracy's services have been much in demand in vaudeville and talking pictures.

EDDIE DUCHIN, the conductor-pianist featured with his orchestra over CBS from New York's Central Park Casino, studied pharmacy before he set out on his musical career. He planned to follow the footsteps of his father, who owns a Boston drug store chain. His piano-playing hobby came to the fore and Eddie definitely shelved pharmacy for dance music. Music was just a hobby to Duchin until one summer when he worked as a waiter in a New England boys' camp and the waiters decided to form an orchestra. The orchestra consisted of three pieces—piano, violin and saxophone. But there was a lot of hard work between the camp music and the bandstand in the swanky Casino. Eddie began his musical studies at the age of nine. As his studies progressed, he invoked some original experiment and style in his playing. He used his musical ability as a source of additional income. He worked in a drug store in the daytime and played at dances in the evening. While in his junior year at Pharmacy College, Eddie won a Leo Reisman audition and

joined the latter's orchestra at New York's old Waldorf-Astoria Hotel. He returned to Boston to finish school and graduated as president of the Class of '29. He joined Reisman at the Central Park Casino and proved so popular that within a year he was permitted to form his own musical organization.

THE famed characters of Potash and Perlmutter, the heroes of six successful plays produced all over the world, three motion pictures and numerous short stories, are now on the air in the persons of Joseph Greenwald as Abe Potash and Lou Welch as "Mawruss" Perlmutter. The new series of dramatizations is presented over an NBC hook-up each Monday, Wednesday and Friday, under the sponsorship of the Health Products Corporation. The new series adds the name of Montague Glass, creator of "Potash and Perlmutter," to the list of eminent authors who have recently turned their attention to radio. Potash and Perlmutter plays are still being presented in the Orient and the Antipodes. In Soviet Russia, musical comedies are built around Glass's characters. Joseph Greenwald appeared in "Abie's Irish Rose" for six consecutive years, three
(Continued on page 187)

POTASH AND PERLMUTTER



ILKA CHASE





IN this sixth installment of the DX Corner we have listed a time schedule of Short-Wave Best Bets, a list of stations logged during the past month at the RADIO NEWS Short-Wave Listening Post in Westchester County, New York. The schedule includes only the best received stations, hourly, from 5 o'clock in the morning to 12 midnight, E. S. T. Space has been left for filling in local time. Space has also been left opposite the call letters for your own dial settings for each station you pick up. Unless otherwise noted stations are heard daily.

Short-Wave "Best Bets"

Wavelengths in Meters	Call Letters	Dial Settings	Local Time
5 A. M. Eastern Standard Time			
31.2+ Sun.	VK2ME
31.5 Wed., Sat.	VK3ME
70.2	RV15
6 A. M. Eastern Standard Time			
16.9	GSG
19.8	GSF
31.2+ Sun.	VK2ME
31.3+	W1XAZ
31.5 Wed., Sat.	VK3ME
49.4+	W8XAL
70.2	RV15
7 A. M. Eastern Standard Time			
13.9+	W8XK
16.9	GSG
19.6	FYA
19.8	GSF
23.3+ Sun.	RABAT
31.2+ Sun.	VK2ME
31.3+	W1XAZ
49.2 Mon., Tues.	VE9GW
49.4+	W8XAL
70.2	RV15
8 A. M. Eastern Standard Time			
13.9+	W8XK
16.8+ Irregular	PHI
16.9	GSG
19.6	FYA
19.7	DJB
19.8	GSF
23.3+ Sun.	RABAT
25.3	GSE
25.4	I2RO
31.2+ Sun.	VK2ME
31.3+	W1XAZ
31.8+	PLV
49.0+	VE9HX
49.2 Mon., Tues.	VE9GW
49.4+	W8XAL
49.9+	VE9DR
70.2	RV15
9 A. M. Eastern Standard Time			
13.9+	W8XK
16.8+ Irregular	PHI
19.6	FYA
19.7	DJB
19.8	W8XK
19.8	GSF
25.3	GSE
25.4	I2RO
25.6 Except Sun.	VE9JR
31.2+ Sun.	VK2ME
31.3+	W1XAZ
31.8+	PLV
49.0+	VE9HX
49.2 Mon., Tues.	VE9GW
49.4+	W8XAL
49.9+	VE9DR
70.2	RV15
10 A. M. Eastern Standard Time			
13.9+	W8XK
16.8+ Irregular	PHI
19.6	FYA
19.6+	W2XE
19.7	DJB
19.8	W8XK
19.8	GSF
25.3	GSE
25.4	I2RO
25.5 Irregular	DJD
26.8+ Sun.	CT3AQ
31.2+ Sun.	VK2ME
31.3+	W1XAZ
31.8+	PLV
49.0+	VE9HX
49.2 Mon., Tues.	VE9GW
49.4+	W8XAL
49.9+	VE9DR
70.2	RV15
11 A. M. Eastern Standard Time			
13.9+	W8XK
19.6+	W2XE
19.7	W8XK
19.7	DJB
25.2	FYA
25.2	W8XK
25.3	GSE
25.4	I2RO
25.5 Irregular	DJD
25.6 Except Sun.	VE9JR
26.8+ Sun.	CT3AQ
31.2+ Sun.	VK2ME
31.3+	W1XAZ
31.5+	YV3BC
31.5+	GSB
49.0+	VE9HX
49.2 Mon., Tues., Sun.	VE9GW
49.3+ Sun.	W9XAA
49.4+	W8XAL
49.9	VE9BJ
49.9+	VE9DR
70.2	RV15
12 NOON Eastern Standard Time			
13.9+	W8XK
19.7	W8XK
19.7	DJB
25.2	FYA
25.4	I2RO
25.5 Irregular	DJD
25.5	GSD
25.6 Sat.	VE9JR
31.2+	W3XAU
31.2+ Sun.	VK2ME
31.3+	W1XAZ
31.5+	YV3BC
31.5+	GSB
49.2 Sun.	VE9GW
49.3+ Sun.	W9XAA
49.4+	W8XAL
49.9	VE9BJ
49.9+	VE9DR
70.2	RV15
1 P. M. Eastern Standard Time			
16.8 Except Sat.	W3XAL
19.7	W8XK
19.7	DJB
25.2	FYA
25.4	I2RO
25.5	GSD
25.5 Irregular	DJD
25.6 Sat.	VE9JR
30.4 Sat.	EAQ
31.2+	W3XAU
31.3+	W1XAZ
31.5+	YV3BC
31.5+	GSB
49.2 Sun.	VE9GW
49.3 Sun.	W9XAA
49.4+	W8XAL
49.5 Temporary	OXY
49.9+	VE9DR
50.0+	HVJ
70.2	RV15
2 P. M. Eastern Standard Time			
16.8 Except Sat.	W3XAL
19.5 Sun.	W2XAD
19.7	W8XK
19.7	DJB
25.2	FYA
25.3	I2RO
26.5+	W2XE
26.5 Irregular	DJD
26.8 Ex. Sat., Sun.	VE9JR
30.4 Sat.	EAQ
31.2	W3XAU
31.3	W1XAZ
31.3	HLB (code)
31.5+	YV3BC
31.5	GSB
49.2 Sun.	VE9GW
49.3 Sun.	W9XAA
49.4+	W8XAL
49.5 Temporary	OXY
49.6+ Sun.	W1XAL
49.9+	VE9DR
70.2	RV15
3 P. M. Eastern Standard Time			
16.8	W3XAL
19.5+ Ex. Tu. Th. Sat	W2XAD
19.7	W8XK
19.7	DJB
25.2	W8XK
25.3+	W2XE
25.4	I2RO
25.5 Irregular	DJD
25.5	GSD
25.6	FYA
25.6 Ex. Sat. Sun.	VE9JR
30.4 Sat.	EAQ
31.2	W3XAU
31.3	GSC
31.3+	W1XAZ
31.5+	YV3BC
31.5+	GSB
32.3 Sun.	RABAT
45.3+ (chimes)	REN
48.8+	W8XK
49.1+ Except Sat.	W9XF
49.2 Th. Fr. Sat. Sun.	VE9GW
49.3 Sun.	W9XAA
49.4+	W8XAL
49.5 Temporary	OXY
49.5+	GSA
49.6+ Sun.	W1XAL
49.9+	VE9DR
50.0	RV59
4 P. M. Eastern Standard Time			
19.7	DJB
25.2	W8XK
25.3+	W2XE
25.4	I2RO
25.5	GSD
25.5	DJD
25.6	FYA
31.2	W3XAU
31.2+ Tues., Fri.	CT1AA
31.3	GSC
31.3+	W1XAZ
31.5+	YV3BC
49.5 Temporary	OXY
32.3 Sun.	RABAT
46.7 Irregular	W3XL
48.8+	W8XK
49.1+	YV1BC
49.1+ Sat.	W3XAL
49.1 Except Sat.	W9XF
49.2 Thu. Fri. Sat. Sun	VE9GW
49.3+ Sun.	W9XAA
49.4+	W8XAL
49.5	GSA
49.9	VE9DR
50.0	RV59
5 P. M. Eastern Standard Time			
19.8	HVJ
25.2	W8XK

25.3+	W2XE	49.9+
25.4	I2RO	50.6 Irregular
25.5	DJD	
26.8+ Tues., Thurs.	CT3AQ	
30.4	EAQ	
31.0	T14NRH	
31.2+	W3XAU	
31.2+ Tues., Fri.	CT1AA	
31.2+	XETE	
31.3	GSC	
31.3 Sun.	HBL	
31.3+	W1XAZ	
31.3+	DJA	
31.5+	YV3BC	
32.3	RABAT	
38.4+ Sun.	HBP	
46.7 Irregular	W3XL	
48.8+	W8XK	
49.0	W2XE	
49.0+	VE9HX	
49.1+	YV1BC	
49.1+ Sat.	W3XAL	
49.1+ Except Sat.	W9XF	
49.2 Th.Fri.Sat.Sun.	VE9GW	
49.3+ Sun.	W9XAA	
49.4+	W8XAL	
49.5+	GSA	
49.5 Temporary	OXY	
49.9	VE9DR	
50.0	RV59	
50.6 Irregular	HJ4ABE	
6 P. M. Eastern Standard Time... Local Time		
19.8	GSF	
25.2	W8XK	
25.6	FYA	
26.8+ Tues., Thurs.	CT3AQ	
30.4	EAQ	
31.0	T14NRH	
31.2+ Tues., Fri.	CT1AA	
31.2+	XETE	
31.3+	W1XAZ	
31.4+	W2XAF	
31.5+	YV3BC	
31.5	GSB	
48.8+	W8XK	
49.0	W2XE	
49.0+	VE9HX	
49.1+	YV1BC	
49.1+ Sat.	W3XAL	
49.1+ Ex. Sat., Sun	W9XF	
49.2 Th.Fri.Sat.Sun.	VE9GW	
49.4+	W8XAL	
49.3+ Sun.	W9XAA	
49.5 Temporary	OXY	
49.9+	VE9DR	
50.6 Irregular	HJ4ABE	
7 P. M. Eastern Standard Time... Local Time		
19.8	GSF	
25.2	W8XK	
25.6 Except Sun.	VE9JR	
25.6	FYA	
31.2	T14NRH	
31.2+	XETE	
31.3+	W1XAZ	
31.3+	DJA	
31.4+	W2XAF	
31.5+	YV3BC	
31.5	GSB	
48.8+	W8XK	
49.0	W2XE	
49.0+	VE9HX	
49.1+	YV1BC	
49.1+ Sat.	W3XAL	
49.2 Sat., Sun.	W9XF	
49.3+ Sun.	VE9GW	
49.4+	W8XAL	
49.5	W9XAA	
49.5+	W3XAU	
49.8	DJC	

49.9+	VE9DR	49.4+
50.6 Irregular	HJ4ABE	49.5
		49.9+
8 P. M. Eastern Standard Time... Local Time		
25.2	W8XK	
25.6	FYA	
25.6 Except Sun.	VE9JR	
31.2+	XETE	
31.3+	W1XAZ	
31.3+	DJA	
31.4+	W2XAF	
31.5+	YV3BC	
48.8+	W8XK	
49.0	W2XE	
49.0+	VE9HX	
49.1+	YV1BC	
49.1+ Sat.	W3XAL	
49.1+ Except Sat	W9XF	
49.3+ Sun.	W9XAA	
49.2 Sat.	VE9GW	
49.4+	W8XAL	
49.5	W3XAU	
49.8	DJC	
49.9+	VE9DR	
50.5	HJ1ABB	
50.6	HJ4ABE	
51.0	HJ2ABA	
9 P. M. Eastern Standard Time... Local Time		
25.6	FYA	
25.6 Except Sat.	VE9JR	
31.0	T14NRH	
31.2+	XETE	
31.3+	W1XAZ	
31.4+	W2XAF	
31.5+	YV3BC	
40.5+	HJ3ABD	
45.3 Thurs.	PRADO	
48.8+	W8XK	
49.0	W2XE	
49.0+	VE9HX	
49.1+	YV1BC	
49.1+ Sat.	W3XAL	
49.1+ Except Sat.	W9XF	
49.2 Sat.	VE9GW	
49.3+ Sun.	W9XAA	
49.4+	W8XAL	
49.5	W3XAU	
49.9+	VE9DR	
50.5	HJ1ABB	
50.6 Irregular	HJ4ABE	
51.0	HJ2ABA	
10 P. M. Eastern Standard Time... Local Time		
25.6	FYA	
31.0	T14NRH	
31.2+ !	XETE	
31.3+	W1XAZ	
40.5+	HJ3ABD	
45.3 Thurs.	PRADO	
45.0 Fri.	TGW	
48.8+	W8XK	
49.0	W2XE	
49.1+ Sat.	W3XAL	
49.1+ Except Sat.	W9XF	
49.2 Sat.	VE9GW	
49.4+	W8XAL	
49.5	W3XAU	
49.9+	VE9DR	
50.5 Thurs.	HJ1ABB	
11 P. M. Eastern Standard Time... Local Time		
25.6 Sat.	VE9JR	
31.2+	XETE	
31.3+	W1XAZ	
45.0 Fri.	TGW	
48.8+	W8XK	
49.1+ Sat.	W3XAL	
49.1 Except Sat.	W9XF	
49.2 Sat.	VE9GW	

W8XAL
W3XAU
VE9DR
Station Locations	
Wavelength	Call Letters
13.9+	W8XK Pittsburgh, Pa.
16.8+	W3XAL Bound Brook, N. J.
16.8+	PHI Huizen, Holland
16.9	GSG Daventry, England
19.5	W2XAD Schenectady, N. Y.
19.6	FYA Pointoise, France
19.6+	W2XE New York, N. Y.
19.7	W8XK Pittsburgh, Pa.
19.7	DJB Zeesen, Germany
19.8	GSF Daventry, England
19.8	HVJ Vatican City
23.3	Rabat, Morocco
25.2	FYA Pointoise, France
25.2	W8XK Pittsburgh, Pa.
25.3	GSE Daventry, England
25.3+	W2XE New York, N. Y.
25.4	I2RO Rome, Italy
25.5	GSD Daventry, England
25.5	DJD Zeesen, Germany
25.6	FYA Pointoise, France
25.6	VE9JR Winnipeg, Canada
26.8+	CT3AQ Funchal, Madeira
30.4	EAQ Madrid, Spain
31.0	T14NRH Heredia, Costa Rica
31.2+	XETE Mexico City
31.2+	W3XAU Philadelphia, Pa.
31.2+	VK2ME Sydney, Australia
31.2+	CT1AA Lisbon, Portugal
31.3	HBL Geneva, Switzerland
31.3	GSC Daventry, England
31.3+	W1XAZ Springfield, Mass.
31.3+	DJA Zeesen, Germany
31.4+	W2XAF Schenectady, N. Y.
31.5	VK3ME Melbourne, Australia
31.5+	YV3BC Caracas, Venezuela
31.5	GSB Daventry, England
31.8+	PLV Bandoeng, Java
32.3	Rabat, Morocco
38.4+	HBP Geneva, Switzerland
40.5+	HJ3ABD Bogota, Col.
45.0	TGW Guatemala
45.3	PRADO Riobamba, Ecuador
45.3+	REN Moscow, U. S. S. R.
48.8+	W8XK Pittsburgh, Pa.
49.0	W2XE New York, N. Y.
49.0+	VE9HX Halifax, N. S.
49.1	YV1BC Caracas, Venezuela
49.1+	W3XAL Bound Brook, N. J.
49.1+	W9XF Chicago, Ill.
49.2	VE9GW Bowmanville, Can.
49.3+	W9XAA Chicago, Ill.
49.4+	W8XAL Cincinnati, Ohio
49.5	W3XAU Philadelphia, Pa.
49.5	OXY Skamleback, Denmark
49.6	GSA Daventry, England
49.6+	W1XAL Boston, Mass.
49.8	DJC Zeesen, Germany
49.9	VE9BJ New Brunswick, Can.
49.9+	VE9DR Montreal, Can.
50.0	RV59 Moscow, U. S. S. R.
50.0+	HVJ Vatican City
50.5	HJ1ABB Barranquilla, Colombia
50.6+	HJ4ABE Medellin, Colombia
51.0	HJ2ABA Tunja, Colombia
70.2	RV15 Khabarovsk, Siberia
Reception Conditions	
During the last month short-wave reception has improved considerably over the pre-	
(Continued on page 184)	

A WELCOME ADDITION TO OUR WESTCHESTER LISTENING POST

There has been added to our fine group of long-distance short-wave receiving equipment the remarkable little short-wave receiver pictured below, through the gift of Mr. James Millen of the National Company. A complete description of our first month's tests on this type FB-7 superheterodyne receiver will appear in an exclusive article in next month's issue



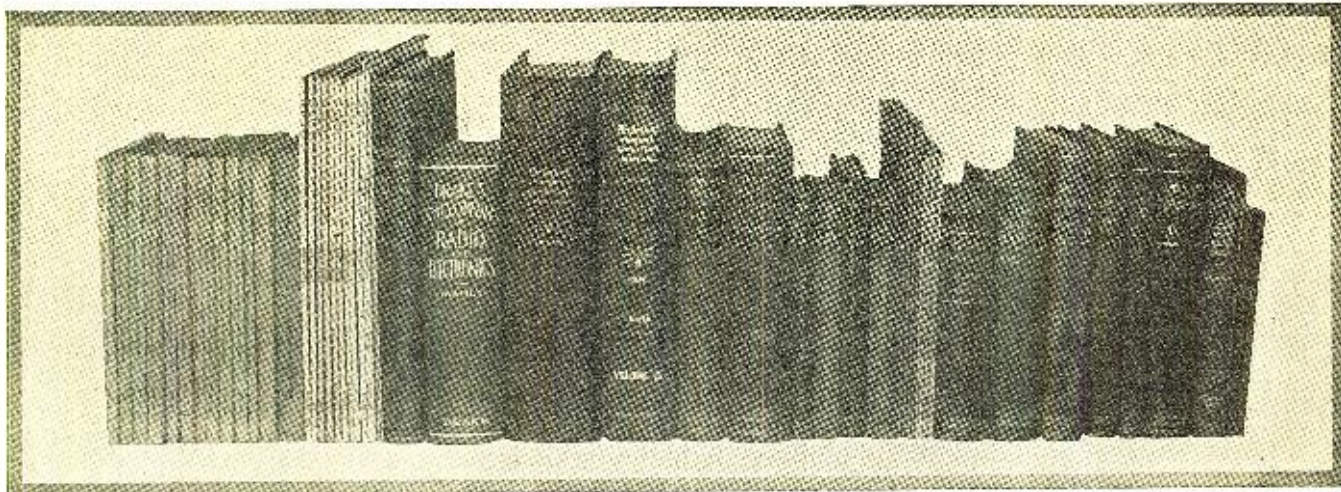

Technical Review

RADIO SCIENCE ABSTRACTS

Radio engineers, laboratory and research workers will find this department helpful in reviewing important current radio literature, books, Institute and Club proceedings and free technical booklets

Television Today and Tomorrow, by Sydney A. Moseley and H. J. Barton Chapple, Third Edition. Sir Isaac Pitman & Sons, London, 1933. The title, as well as the "Preface to the Third Edition," would lead one to think that this work would treat all systems of television. Nothing is farther from the truth. The authors have restricted themselves entirely to the work of John Logie Baird, hardly mentioning any others. This seems to have been done—so the introduction says—to get even with the Americans who wrote books on television wherein "an altogether insufficient tribute was given to the man who had done more for television than any of his contemporaries."

The first chapter is entitled "History of Television." It sketches the early days of the Baird Co. The next chapters are devoted to a popular treatment of the fundamental principles of television, including the scanning disk, photoelectric cells, neon lamps and Baird's system of synchronism. The receiver for television is explained in the following chapter. Several circuits of a.f. amplifiers are given and the causes of negative images are illustrated. In the following three chapters one finds an account of the extension of television principles to the tele-cinema, to the "noctovisor" and to the recording or "bottling up" of pictures. These are some of the most interesting chapters in the book. The final chapters include the later improvements and refinements. Among these are "color and stereoscopic television," the projecting of larger pictures, ultra-short waves, etc.

The work concludes with a very brief review of the work done in other countries.

What to Read About Radio, by Levering Tyson. The University of Chicago Press. This is a publication of the National Advisory Council on Radio in Education. The pamphlet is written in the form of an interview of Mr. Tyson by an imaginary visitor who has realized the possibilities of radio broadcasting and wishes to obtain "information about radio." Mr. Tyson then explains how complicated the subject is and suggests the reading of some article, book or bulletin at frequent intervals. A list of all

Conducted by
Joseph Calcaterra

recommended publications is given at the end. The list is concerned chiefly with one aspect of radio broadcasting—that of educational programs and of better programs in general.

Review of Articles in the June, 1933, Issue of the Proceedings of the Institute of Radio Engineers

A Radio Range Beacon Free from Night Effects, by H. A. Chinn. In the radio range beacon described in this paper, advantage is taken of the phenomenon that waves of frequencies higher than 30 megacycles per second are not usually refracted back to the earth by the Kennelly-Heaviside layer, to obtain a radio range beacon entirely free from atmospheric variations or "night effects."

On the Solution of the Problem of Night Effects with the Radio Range Beacon System, by H. Diamond. This paper describes the transmission-line antenna system, which eliminates the troublesome night effects experienced in the use of radio range beacon systems. The paper also includes a theoretical analysis of the phenomena underlying the occurrence of night effects and how to eliminate them.

Theoretical Notes on Certain Features of Television Receiving Circuits, by Gordon D. Robinson. A number of important factors which determine the proper relation of circuit constants and arrangement in order to get most efficient operation in television circuits are discussed in this paper. Special attention is given to the design of suitable resistance-coupled amplifiers and the effect of the addition of a certain amount of inductance in the circuit of a resistance-coupled amplifier.

Class B Amplifiers Considered from the Conventional Class A Standpoint, by J. R. Nelson. In this paper, the theory developed

from an analysis of the wave-form of the output current of an ideal tube, when plate current cut-off occurs between zero and 180 degrees of the cycle, is applied to practical tubes. The manner in which a diagram may be constructed from the characteristics of the tube for any operating condition from Class A to Class B with half the wave cut-off, is shown.

Review of Contemporary Literature

An Acoustic Illusion, Telephonically Achieved, by Harvey Fletcher. Bell Laboratories Record, June, 1933. A description of some interesting methods used to accomplish binaural reception and a discussion of the factors which are involved in producing true "perspective" sound reception.

Use of Filters in Carrier Systems, by R. H. Mills. Bell Laboratories Record, June, 1933. A detailed description of the design factors which permit the use of a single telephone line for the transmission of several telephone and telegraph communications, simultaneously, but without interference, by means of suitable filter systems, is described in this paper.

Delayed Speech, by C. N. Hickman. Bell Laboratories Record, June, 1933. This paper contains a description of a simple steel-tape magnetic recorder and reproducer which can be used to produce any desired time delay in the transmission of speech or electrical impulses. The idea has been used to produce the echo effect in one of the Century of Progress exhibits.

Improved Current Control for Low-Range Meter Calibration, by F. R. Dennis. Bell Laboratories Record, June, 1933. This paper describes a simple and efficient method of making low-range meter calibrations which requires considerably less space and much less time in making the calibrations than has been possible with older methods.

On Minimum Audible Sound Fields, by L. J. Sivian and S. D. White. The Journal of the Acoustical Society of America, April,

1933. This paper gives the results of measurements made to determine the minimum audible field (m.a.f.) over a frequency range of 100 to 15,000 c.p.s. for monaural hearing and over a range of 60 to 15,000 c.p.s. for binaural hearing. Minimum audible pressures (m.a.p.), as measured at the observer's eardrums, are also given.

Characteristics of Radio Tubes. Arcturus Radio Tube Company. A loose-leaf book of technical data on Arcturus tubes. It consists of a tube chart and a sheet for each type, giving characteristics, curves, dimensions and circuits. There is also an explanation of symbols which gives the new numbering of tubes as well as an explanation of all symbols employed in the manual. We notice that the pin-numbering scheme is not the same as the R.M.A. standards.

Radio Servicing Instruments from the Engineering Viewpoint, by J. H. Miller. Proceedings of the Radio Club of America, May-June, 1933. A discussion of the volt-ohmmeter, the microammeter and the capacity meter. Equations are derived for the calculation of the scale for both the ohmmeter and the capacity meter.

A Tuning-Fork Audiometer and Noise Observations in Newport News, Virginia, by E. Z. Stowell. The Journal of the Acoustical Society of America, April, 1933. A description of a compact instrument for measuring sound and noise levels, which depends on the measurement of a given noise by comparison with the known initial amplitude and rate of decay of a tuning fork. Measurements are comparable in accuracy under most conditions with those of electron-tube audiometers.

Amplification of Transients, by C. H. Smith. The Wireless Engineer and Experimental Wireless, June, 1933. This article gives a mathematical analysis which indicates the discrepancies between the response of a receiver to steady tones and to transient waves.

A Valve Voltmeter for Audio Frequencies. The Wireless Engineer and Experimental Wireless, June, 1933. An audio-frequency tube voltmeter which can be calibrated by direct current and which has constant calibration for all frequencies in the audible range is described in this article.

The Convenient Measurement of C, R, and L, by Robert F. Field. The General Radio Experimenter, April-May, 1933. A description of the General Radio type 650-A impedance bridge, designed to simplify measurement of capacity, resistance and inductance.

Pitch and Intensity Measurements with a Vacuum-Tube Oscillator, by Arthur E. Thiessen. The General Radio Experimenter, April-May, 1933. This article describes the General Radio vacuum-tube oscillator used for experiments requiring the production of sounds of from 5 to 10,000 cycles per second. Provision can be made for varying the intensity as well.

Code for Protection Against Lightning. Handbook of the Bureau of Standards No. 17. A manual on the protection of persons, property and buildings containing inflammable liquids and gases against lightning hazards.

Electronics at the Chicago World's Fair. Electronics, June, 1933. This article contains a description of the many uses to which electronic devices have been put in lightning and operating the exhibits at the "Century of Progress" Exposition.

Trends in Radio Design and Manufactur-

ing. Electronics. The trend toward the use of large separate loudspeakers in connection with small receivers to obtain better tone quality, the increasing popularity of reflex circuits to produce smaller sets and the advent of the all-metal tubes are discussed in this article.

Duplex Portables, by F. B. Keefer and L. E. Grant. QST, June, 1933. A description, giving circuit and constructional information on a combination transmitter and receiver weighing only 23 pounds and therefore permitting its use as a portable outfit which does not require the use of a car for transportation.

Circuits Within Circuits, by George Grammer. QST, June, 1933. A discussion of the causes and cure of parasitic oscillations in neutralized circuits covering low-frequency, high-frequency and ultra-high-frequency circuits.

A Study of Hum Generation in Vacuum Tubes as Affected by Heater Design, by J. J. Glauber and A. G. Campbell. Radio Engineering, June, 1933. A study of the factors which contribute to hum in vacuum tubes and to what extent the filament design and voltage is important in limiting hum in a.c. tubes.

The New Sets. Radio Retailing, June, 1933. A listing, with photos and price ranges of the most important new home and auto-radio models.

How to Get Copies of Articles Abstracted in This Department

The abstracts of articles featured in this department are intended to serve as a guide to the most interesting and instructive material appearing in contemporary magazines and reports. These publications may be consulted at most of the larger public libraries, or copies may be ordered direct from the publishers of the magazines mentioned.

RADIO NEWS cannot undertake to supply copies of these articles. They are NOT included in the RADIO NEWS Free Technical Booklet Service.

Free Technical Booklet Service

THROUGH the courtesy of a group of manufacturers, RADIO NEWS offers to its readers this Free Technical Booklet Service. By means of this service, readers of RADIO NEWS are able to obtain quickly and absolutely free of charge many interesting, instructive and valuable booklets and other literature which formerly required considerable time, effort and postage to collect. To obtain any of the booklets listed in the following section, simply write the numbers of the booklets you desire on the coupon appearing at the end of this department. Be sure to print your name and address plainly, in pencil, and mail the coupon to the RADIO NEWS Free Technical Booklet Service. Stocks of these booklets are kept on hand and will be sent to you promptly as long as the supply lasts. To avoid delay, please use the coupon provided for the purpose and inclose it in an envelope, by itself, or paste it on the back of a penny postcard. The use of a letter asking for other information will delay the filling of your request for booklets and catalogs.

Review of Technical Booklets Available

1. *Radio Parts and Sets 1933 Spring and Summer Catalog No. 54.* A catalog of 152 pages, issued by the Wholesale Radio Service Co., one of the oldest mail-order houses. The catalog contains illustrations, descriptions, specifications, list and net prices of a variety of radio parts, tools, replacement items, receiver chassis, complete sets, public-address systems and electrical merchandise required by dealers, servicemen, set builders, amateur and commercial operators, experimenters and engineers.

2. *1933 R.F. Parts Catalog.* An 8-page folder containing specifications on the entire line of Hammarlund variable and adjustable condensers, r.f. transformers, sockets, shields and miscellaneous parts for broadcast and short-wave receivers, complete short-wave receivers and transmitting variable condensers.

4. *A 15 to 200-Meter Comet "Pro" Superheterodyne.* A description of the outstanding features of the Hammarlund-Roberts high-frequency superheterodyne designed especially for commercial operators for laboratory, newspaper, police, airport and steamship use.

5. *A 1933 Volume Control, Fixed and Variable Resistor Catalog.* This 12-page catalog, issued by Electrad, Inc., gives data on standard and special replacement volume controls, truvolt adjustable resistors, vitreous wire-wound fixed resistors, voltage dividers and other resistor specialties and public-address amplifiers (using new tubes). Many revisions and additions to the Electrad 1932 line are included.

6. *Line-Voltage Control.* Characteristics and uses of voltage regulator and chart showing the correct Amperite recommended by set manufacturers for their receivers. Also tells how to improve your customers' sets and make a profit besides.

7. *Rich Rewards in Radio.* This 64-page book is filled with interesting information on the growth of radio and the opportunities existing in the field of radio manufacturing, radio servicing, broadcasting, talking pictures, television, public-address systems and commercial station operation on land and sea, for men who are trained to fill the many jobs created by the radio and allied industries. The book also contains information on the home-study courses in radio and allied subjects offered by the National Radio Institute. This book is available only to RADIO NEWS readers who are over 16 years of age and who are residents of the United States and Canada.

9. *Catalog of Fixed, Metallized and Precision Resistors.* This 16-page catalog gives specifications of the International Resistance Co. 1933 line of metallized, wire-wound and precision wire-wound resistors, motor-radio suppressors, handy servicemen's kits, valuable technical data and list of free bulletins available on the building of servicemen's test equipment.

10. *Information on the Suppression of Motor-Radio Noises.* This folder of the International Resistance Co. gives information on how to overcome motor-generator, ignition-coil, interrupter and spark-plug noises in automobile radio installations.

16. *R.M.A. Standard Resistor Color-Code Chart.* A handy postcard-size color-code chart designed by the Lynch Mfg. Co., to simplify the job of identifying the values of resistors used in most of the standard receivers. It also contains a list of the most commonly used values of resistors with their

corresponding color designations. A catalog of Lynch products is included.

18. *Volume Controls, Fixed Resistors, Motor-Radio Spark Suppressors and Power Rheostats.* A 1933 catalog containing descriptions, specifications and prices of the line of Centralab standard, special and replacement volume controls for receivers, amplifiers, public-address systems and talkie installations, fixed resistors, motor-radio spark suppressors, wire-wound rheostats and potentiometers. Details are given on how to obtain, without charge, a copy of the 64-page Centralab Volume Control Guide for Servicemen.

25. *Noise-Reducing Antenna Systems.* This folder describes the two types of noise-reducing systems perfected by the Lynch Mfg. Co. for both broadcast and short-wave reception. The transposition type can be used on both long and short waves and is especially adapted for use in connection with all-wave and amateur receivers. The shielded transmission type is especially suited for use on broadcast receivers.

29. *Practical Radio Engineering.* This 32-page catalog gives details on the courses offered by the Capitol Radio Engineering Institute of Washington, D. C., to fit the requirements of professional radiomen, radio servicemen, operators and technicians, who are ambitious to get into the higher paid positions in radio reserved for those with advanced training. Three types of courses are offered: (1) an intensive 9-months' full-time resident course requiring regular attendance at classes; (2) a complete home-study course which can be mastered entirely at home and (3) a combination home-study and post-graduate resident course consisting of the regular home-study course followed by 10 weeks' practical training at the school with regular full-time attendance at classes. (Please do not write for this catalog unless you are interested in taking up a course on radio.)

34. *Serviceman's Replacement Volume-Control Guide.* A 44-page pocket-size booklet containing a revised list, in alphabetical order, of all old and new receivers showing model number, value of control in ohms and a recommended Electrad control for replacement purposes. Contains specifications and volume-control circuits for over 2000 different receiver models. A handy booklet which should be in every serviceman's kit.

39. *Radio Servicing and Radio Physics.* A 4-page folder which gives descriptions and tables of contents of two inexpensive books on every phase of radio. The books are written by A. A. Ghirardi and Bertram M. Freed and should be in the libraries of every radio student, experimenter and serviceman. The fact that they are used as standard texts by many radio schools and that chapters have been reprinted in RADIO NEWS is an indication of their value.

42. *How to Build Useful Servicing and Testing Instruments with Simple, Standard Meters.* This bulletin gives data, with diagrams, showing how any meter—preferably a low-range milliammeter—can be used to measure amperes, volts and ohms over any desired range through the use of proper shunt and series resistors. The bulletin has been prepared by the Lynch Mfg. Co. and gives both the theoretical and practical data required to make all the calculations to convert or change the range or function of a given meter.

43. *How to Modernize Old Set Analyzers.* This folder describes the new set analyzer remanufacture plan perfected by the Supreme Instruments Corp. for the conversion (Continued on page 183)

Announcing..... the WESTON Method of SELECTIVE ANALYSIS

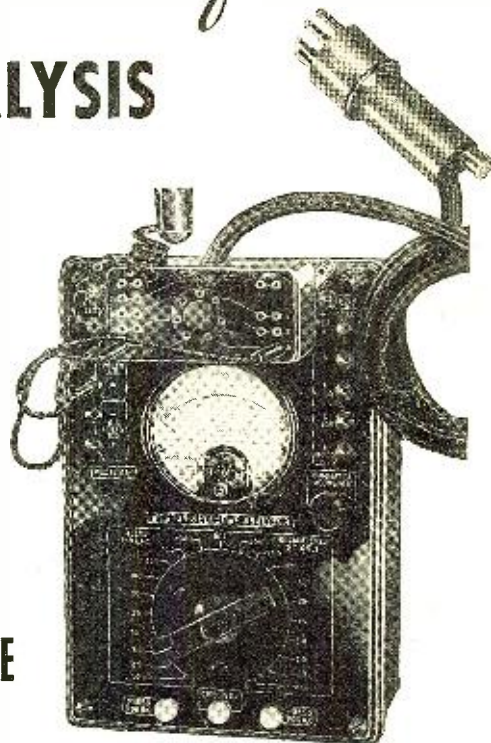

ANALYZER OBSOLESCENCE is banished!

No longer is there the slightest need for worrying about Analyzer obsolescence. Weston has found the solution, providing a design which is always up-to-date regardless of tube developments. It's a method of Selective Analysis involving the new Weston Model 665 Selective Analyzer and suitable Tube Selectors.

Weston Model 665 Selective Analyzer contains all the necessary voltage, current and resistance ranges. Tube Selectors to accommodate 4, 5, 6 and 7 prong tubes are provided. You merely attach the proper Tube Selector to the Selective Analyzer. Next in-

sert the plug into the tube socket of the radio set. Then by plugging into the proper jacks, voltage, current and resistance may be read in any part of the entire network leading to the tube socket.

The Weston Model 665 Selective Analyzer with Tube Selectors truly is universal in its capacity to analyze radio receivers. New tubes

merely mean a new, inexpensive Tube Selector. That's how obsolescence is eliminated. Return the coupon today for complete information... Weston Electrical Instrument Corporation, 615 Frelinghuysen Ave., Newark, N. J.

Modernize Your Analyzer with Weston Socket Selector Units

Your present Analyzer can be brought up-to-date and kept that way by means of the new, inexpensive Weston Tube Selectors which can be used with all models and makes of Analyzers. Return the coupon for descriptive bulletin.

WESTON Radio Instruments

Weston Electrical Instrument Corporation
615 Frelinghuysen Ave., Newark, N. J.

Please send bulletin describing Model 665 Selective Analyzer and Tube Selectors.

Name.....

Address.....

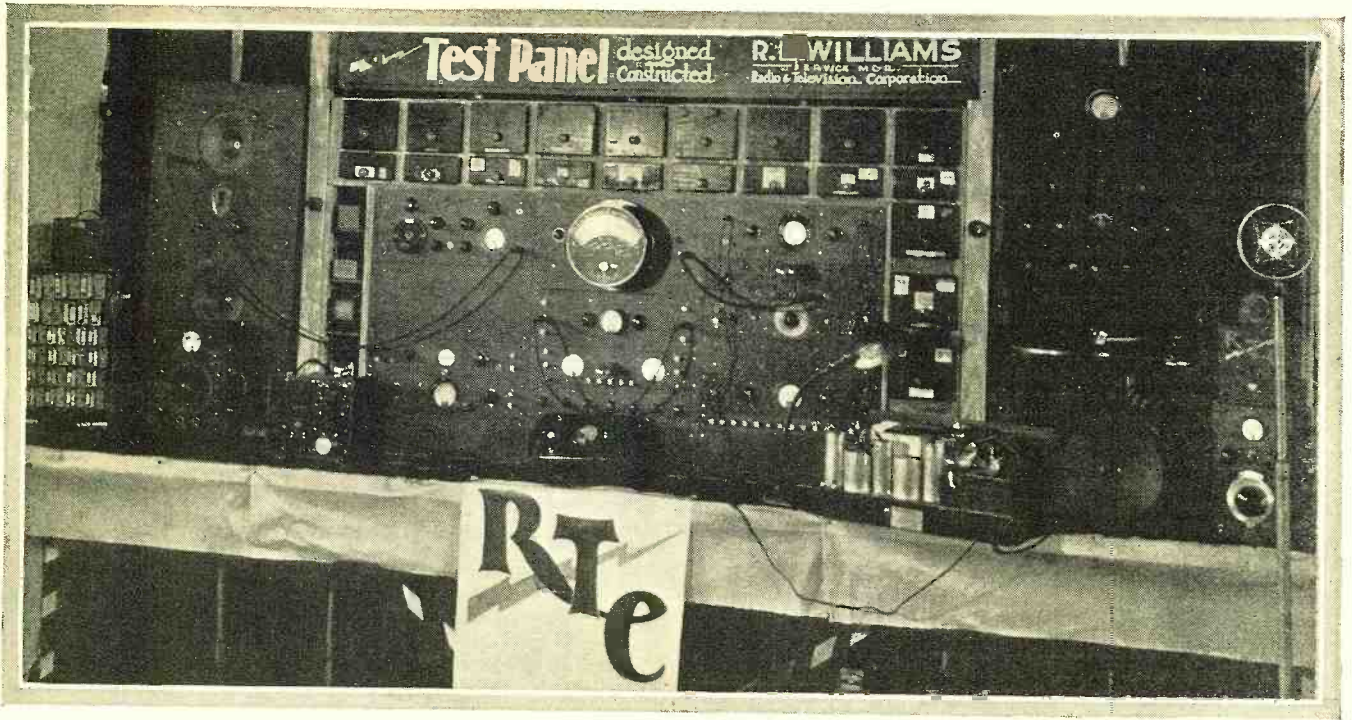

The Service Bench

Service Equipment—Ohmmeters, Condenser Tester, Universal Meter, Modernization; Dynatron Oscillator; Battery-Heated Soldering Iron; Wire Scraper; Service Shops; Service Notes—Care in Console Installation, Philco Marketing, General Parts Line; R.M.A. Color Code; Sales Promotion—Window Displays, The Service Truck

Conducted by
Zeh Bouck

THE ability of a serviceman to make money will vary, in many instances, with the elaborateness of his equipment. The primary purpose of equipment is to enable the operator to do a better job in less time—in other words, to insure the satisfaction of a rising clientele. The conventional test set and analyzer represents the longest single stride in this direction. However, the advent of new tubes and circuits, with the development of additional test methods, recommends the modernization of old apparatus and the design of further test equipment in maintaining the fast pace of efficient radio servicing. It is to these considerations, which ultimately tone the tinkle of the cash register, that we dedicate the following contributions by the servicemen readers of RADIO NEWS.

Two Ohmmeter Circuits

Figure 1 is an ohmmeter arrangement suggested by Morris Chernow of Brooklyn, N. Y. It presents a somewhat novel variation from the conventional method of resistance measurement, and is particularly suitable for low-resistance determination. Mr. Chernow points out that the usual system of checking resistance calls for a fixed voltage used in conjunction with a 0-1 milliamper meter and a series unknown value of resistance. The current varies with different resistors, the resistance of which is equal to the constant voltage over the current in amperes. The disadvantages of this system are the facts that, in the average ohmmeter, the compensation for battery "age" is only approximate, and on low values the resistance of the meter introduces a considerable discrepancy.

The circuit of Figure 1 reverses the order of things. The current is kept constant and the voltage varied—the resistance still being equal to the voltage divided by the current. The meter is the same 0-1 milliamper type.

Shunts R1 and R2, respectively, increase the meter range to .01 ampere and .1 ampere. The voltage source may conveniently be a tapped 22.5-volt "B" battery. If the ap-

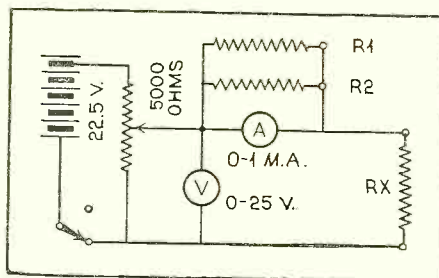

FIGURE 1

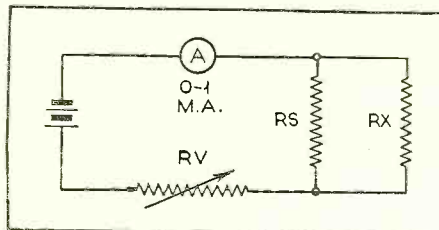

FIGURE 2

proximate value of the resistor, R_x , is not known, measurements should be commenced on the lowest resistance range—i.e., with the .1 ampere shunt.

The voltage is adjusted by the potentiometer until the meter is at full-scale deflection. The resistance will then be equal

to the voltage reading times 10, 100 or 1000, respectively, for the .1, .01 and .001 ranges. Obviously, battery deterioration, outside of absolute debility, can have no effect on the accuracy of the reading. Also, the resistance of the meter itself is negligible on low ranges, due to the extremely low values of the shunts.

A simple method of extending the range of any ohmmeter through the principle of parallel resistors is shown in Figure 2, contributed by Mr. William Naken, of Chicago, Ill. With the elimination of R_s , this presents the conventional calibrated or direct-reading ohmmeter circuit, where R_v is the usual limiting resistor (adjusted for full-scale deflection with the test posts short-circuited) and R_x the unknown resistor. The upper range of this circuit can be considerably increased by connecting a shunt resistor, R_s , of a known value somewhere near the reliable upper limit of the ohmmeter.

The ohmmeter will now read the value of the parallel resistor, or R . By the law of parallel resistors,

$$R = \frac{R_s R_v}{R_s + R_v} \quad \text{or} \quad R_x = \frac{R R_s}{R_s - R}$$

For example, let's assume a direct-reading ohmmeter, giving measurements as high as 10,000 ohms without overcrowding on the left-hand side of the scale. We arbitrarily select this value (10,000 ohms) for R_s . We connect our unknown resistor in the circuit and observe the reading on the ohmmeter—say, 6600 ohms, a value considerably below the maximum range of the meter, and therefore easy to read with some degree of accuracy.

Substituting in our equation, we find

$$R_x = \frac{6600 \times 10,000}{10,000 - 6600} = \frac{66,000,000}{3400} = 20,000 \text{ ohms (approximately)}$$

Condenser Tester

A minor variation in the usual vacuum-tube voltmeter circuit provides a convenient check on condensers from .05 to 2 mfd., immediately indicating open, short-circuited or leaky capacitors. We are indebted to Philco for the diagram and values shown in Figure 3.

Before test, the milliammeter is adjusted to full-scale deflection by means of the 30-ohm filament rheostat. When a perfect con-

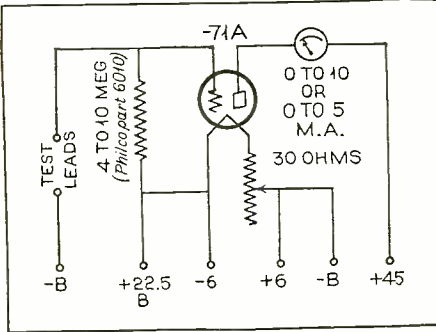

FIGURE 3

denser is connected across the test leads, the charging current causes an IR drop in the grid leak which places a momentary negative bias on the grid, causing the plate current to drop. The extent and duration of the drop increases with the capacity of the condenser. After the condenser is fully charged, the charging current falls to zero, and the meter returns to full-scale reading. If the condenser is leaky, having some resistance (even as high as 100 megohms), the needle will not return to the maximum reading. The lower the reading, the greater the leakage. If the condenser is short-circuited, the needle of the meter will swing left to zero—or to the value indicated when the test leads are directly crossed. An "open" gives no deflection. (Due to the constant leakage current, electrolytic condensers cannot be tested by this device.)

A Universal Volt-Ampere-Ohmmeter

The versatility of the 0-1 milliamper meter is well demonstrated in the diagram of Figure 4, which shows the circuit arrangement of a universal meter designed and con-

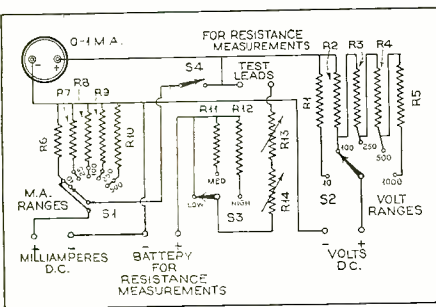

FIGURE 4

structed by C. W. Johnson of Morris, Okla. The following parts, keyed with the diagram, were employed:

- M—Pattern 83 Jewell, 0-.001 ampere, d.c., with special dial
- S1—Yaxley No. 1625 switch, 2-gang, 6-point, non-short-circuiting type
- S2—Yaxley No. 1615 switch, 1-gang, 5-point, non-short-circuiting type
- S3—Yaxley No. 1613 switch, 1-gang, 3-point, non-short-circuiting type
- S4—H. & H. off-on toggle switch
- R1—Lynch type LW-1 precision resistor, 10,000 ohms
- R2—Lynch, type LW-1 precision resistor, 100,000 ohms
- R3—Lynch type LW-1 precision resistor, 150,000 ohms

- R4—Lynch type LW-1 precision resistor, 250,000 ohms
 - R5—Lynch type LW-1 precision resistor, 500,000 ohms
 - R6—10 ma. meter shunt made from old resistor strip
 - R7—25 ma. meter shunt made from old resistor strip
 - R8—100 ma. meter shunt made from old resistor strip
 - R9—250 ma. meter shunt, Jewell Pattern 88
 - R10—500 ma. shunt, Jewell Pattern 88
 - R11—Ohiohm carbon resistor, 20,000 ohms
 - R12—Ohiohm carbon resistor, 40,000 ohms
 - R13—Yaxley Junior variable resistor, 5000 ohms
 - R14—Yaxley Junior rheostat, 50 ohms
- Eight No. 751 Yaxley tip-jacks
One 7-inch by 9-inch Goodrich hard-rubber panel

The general construction of the Universal meter will vary from serviceman to serviceman. Mr. Johnson mounted all the parts in a small box, 7 inches by 9 inches by 4½ inches. The operation is indicated in the diagram, and the following measurements are possible:

VOLTMETER

(All made with S4 open)

- 0- 10 volts d.c., 1000 ohms per volt
- 0- 100 " " " " " "
- 0- 250 " " " " " "
- 0- 500 " " " " " "
- 0-1000 " " " " " "

MILLIAMMETER

(All Made with S4 closed)

- 0-.001 ampere, d.c.
- 0-.01 " " "
- 0-.1 " " "
- 0-.25 " " "
- 0-.5 " " "

OHMMETER

- 0-1000 ohms—S3 on "low," S1 to 100 ma., S4 closed—4.5 volts
- 0-10,000 ohms—S3 on "low," S1 to 10 ma., S4 closed—4.5 volts
- 0-100,000 ohms—S3 on low, S4 open—4.5 volts
- 0-500,000 ohms—S3 on "med," S4 open—22.5 volts
- 0-1,000,000 ohms—S3 on "high," S4 open—45 volts

On the two lowest ranges, balancing is effected by R13 and R14. On all other ranges, R13 alone is sufficient for the full-scale adjustment.

A special scale is provided for this meter by the manufacturer and costs ninety cents. This makes all measurements direct reading as far as the cardinal figures are concerned, it being only necessary to locate the decimal point.

Modernization of Old Test Equipment

With the continuous advent of new tubes, only the ingenuity of the serviceman stands between his original test equipment, often representing a goodly cash outlay, and obsolescence. The general principles of modernization are obvious to the experienced radio-trician, and the parts required will vary with the type of original apparatus. There will usually be required an additional meter, several adapters, one or more push-buttons and new sources of potentials. For instance, in modernizing the Holt Model 100 tester, George Olson, of Olson's Radio Service, Carlington, N. D., provided two special adapters for testing screen-grid, variable-mu and pentode tubes, in addition to one UX socket, a "C" plus binding post, a.c. filament transformer, a 22.5-volt "C" battery, four flashlight cells and a 0-5 a.c. voltmeter.

A convenient method of assembly is to mount the auxiliary apparatus and the original test set in a second and larger carrying case, as suggested by Mr. Olson in Figure 5.

Boris Naimark, of New York City, points out that the automotive group of tubes can be readily tested on equipment designed

(Continued on page 188)

SERVICE PROFITS ASSURED
WITH THE
RCA RADIOTRON CUNNINGHAM RADIO TUBE SERVICE SYSTEM

SERVICE ORDER FORM
(Similar Form for Cunningham)

The Service Order Form is one of the most popular features of the RCA Radiotron-Cunningham Service System, comprising also a Prospect, Sales and Service Record Form, Service Billhead, Not-at-Home Card, Service Post Cards, Service Advertising—Mats and numerous other profit-building items.

Thousands of dealers and service men are making money on service, right this minute, with the aid of the Service Order Form.

This form offers the service man a simple, complete, accurate method of making charges and recording service work done.

Its very completeness stimulates the service man to do a thorough job. Space for "complaint" is a time saver because as many facts as possible are ascertained in advance.

Complete customer information is compressed into one line with the use of symbols.

50 triplicate sets to a pad. Radiotron Item No. 319. Cunningham Form No. 1180. Price, imprinted, with six sheets of carbon paper, 3 pads for \$1.25.

PROMOTION DEPT., R. N. RCA, Harrison, N. J.:

I enclose \$1.25 (cash) (check) (money order). Send me 1 set of Service Order Forms (3 pads).

- Dealer RCA Radiotron
- Service Man Cunningham

Name.....
Street.....
City..... State.....

Radio Physics Course

LESSON TWENTY-ONE—ELECTROMAGNETISM

Ampere-Turns to Produce a Given Flux

If a magnetic circuit is not uniform, its total reluctance is obtained by considering the reluctance of its several parts, just as in the case of resistances in electrical circuits. If two reluctances are in series, the total reluctance is the sum of the individual reluctances. For two reluctances in parallel, the total reluctance is equal similarly to the reciprocal of the sum of the reciprocals of the separate reluctances (as in the case of resistances).

It is evident that the use of the B-H curves makes the solution of problems of this kind very simple. Curve sheets for the various steels may be obtained from handbooks on steel, or by direct application to the steel manufacturers. The latter is probably the most accurate source of information for the magnetic characteristics of the many special steels made for use in electrical devices.

Hysteresis Loss

When a piece of iron is subjected to a varying magnetizing force (as in the case of transformer cores) the magnetism produced in it lags behind the magnetizing force. Thus let (A) of Figure 1 represent an electromagnet having a *hard steel core*, and with current flowing as shown by the arrows, and the magnetic poles as shown, and (A) of Figure 3 represent the changes of magnetism plotted against the applied magnetizing force. The horizontal scale (abscissa) to the right of the starting point O, represents the strength of the current or magnetizing force in one direction; that to the left of O is in the opposite direction. The vertical scale (ordinates) above O represents the total magnetic flux in the steel in the one direction; that below O represents the flux in the reverse direction.

If the current is slowly increased, the magnetic flux in the iron also increase along O-B, up to the point C, where saturation is reached. If the current is now gradually decreased, the iron loses some of its magnetic lines of force, but when the current reaches zero, the iron still has some lines of force O-D left in it as residual magnetism. If the current is now reversed so that it flows in the opposite direction, when the current reaches a certain strength the magnetic flux in the iron has just come down to zero at point E. It required a magnetic force O-E in the opposite direction to completely demagnetize it. If the current is slowly increased in this opposite direction, the iron becomes slowly magnetized again along E, F, G, but in the opposite direction; that is, its poles have changed. If the current is again reduced to zero, the magnetism decreases along G-H, the iron still retains some flux, and the current must be reversed again to demagnetize it to point I. The variations in the magnetic field of the iron thus lag behind those of the current or magnetizing force. If the current is sent through again in the original direction, the magnetism will build up along I-J to the point of saturation C, and the process is repeated over again.

The atoms of the iron do not easily change their positions. It requires a certain magnetic force to change them around. Some of the energy of the applied electric current is used up in changing the magnetism

By Alfred A. Ghirardi

of the iron. The property of a magnetic substance to maintain the magnetic state which it has once acquired, is called *hysteresis*. The electrical energy used up in changing the magnetization of the iron is known

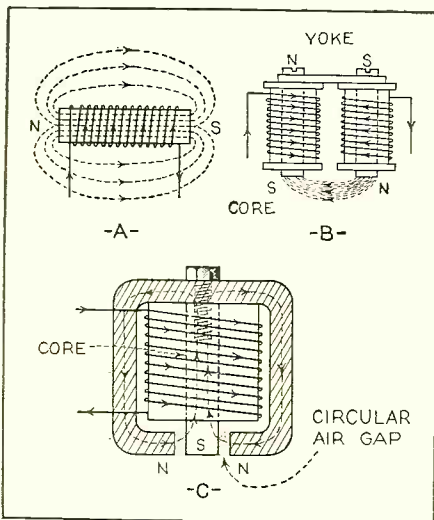

Figure 1. Three different forms of electromagnets: (A) A straight bar electromagnet. (B) A form of horseshoe electromagnet. (C) An iron-clad electromagnet (coil completely enclosed by iron)

as *hysteresis loss* and is supplied by the magnetizing winding. Hysteresis loss is very important in the magnetic materials used for the cores of alternating current electrical apparatus where the flux changes from zero to maximum to zero, and also changes its direction 120 times every second in ordinary light circuits, and at very much higher rates in audio and radio-frequency apparatus. Designers of electrical apparatus usually select

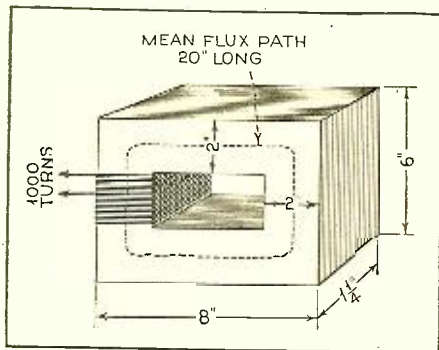

Figure 2. Transformer core

grades of iron which have low hysteresis losses, for a certain amount of electrical energy is wasted in reversing the magnetism during each cycle. Soft iron and annealed silicon steel offer less opposition to changing magnetism than the harder forms of iron and tempered steel. Soft iron and silicon steel therefore have less hysteresis loss than the other common forms of iron.

The reason for the hysteresis effect is that, owing to the forces between the atoms when they have all been turned around to the magnetized position, there is a constraint

which prevents the magnetism of the iron from being reduced proportionally to the reduction of the magnetizing force, so that when the latter is reduced to zero, there is a considerable amount of residual magnetism still in the iron, corresponding to points D and H in Figure 3. In other words, the changes in the magnetic induction lag behind the changes in the magnetizing force. It is this retentive property of steel which enables us to make permanent magnets. The energy expended by reason of the effect all appears as heat energy in the steel, because when each atomic group is separated, the individual members are set vibrating, the corresponding kinetic energy being transformed into heat.

The hysteresis curve for hard steel is shown in (A) of Figure 3. The curve at (B) of Figure 3 is for annealed silicon steel used extensively in the magnetic circuits of transformers, dynamos, etc., on account of its low hysteresis and eddy-current losses. (Notice that in this case the loop is more slender; that is, the magnetism changes more readily, hence there is much less energy loss. Note that the magnetic force DE required to bring the magnetism back to zero value is much less in this case than in the case of the hard steel in (A).

(At (C) is shown the hysteresis curve for an ideal magnetic material; that is, the curve obtained for a steel having no hysteresis loss. In this case, when the magnetizing force is reduced to zero, the magnetic strength of the iron also drops to zero at once and no force is required to demagnetize the iron. Of course, in devices in which the magnetic flux does not change in direction or strength, no hysteresis action or loss is present, and it need not be considered when selecting the magnetic material.

Selecting Material

The problem of selecting the proper magnetic material for any magnetic or electrical device usually results in a compromise between several conflicting factors. While a designer will always try to use the steel which he believes will meet all requirements as to permeability, low hysteresis loss, ease of machining, flux density at saturation, etc., the element of cost must always be considered. It is sometimes much cheaper to use a slightly larger magnetic circuit made of a cheaper grade of steel than it would be to make the magnetic circuit more compact by using a more expensive but better grade of steel. In both cases the results obtained might be the same. Of course, whether the device is to be used with a.c. current in the magnetizing winding or with direct current determines whether it can be cast cheaply in a solid piece by the use of cast iron, wrought iron or a soft steel casting, or whether it must be built up of thin individual laminations to reduce the wasteful eddy currents which might be produced by the varying field, as we shall see later. In the case of permanent magnets, while we know that cobalt steel makes very good magnets which are much stronger than tungsten steel magnets of equal size, in many applications where size is not an important factor it might be preferable to make the magnet of the cheaper tungsten steel even though it will be larger in size. An example of this is furnished by the use of tungsten-steel permanent magnets in those types of loudspeakers in which a permanent magnet is employed. Cobalt steel magnets could be used, but they would be more ex-

* Radio Technical Pub. Co., Publishers' Radio Physics Course.

pensive. Since there is ample space for the magnet, the somewhat larger, but cheaper, tungsten-steel magnet is usually employed for this purpose. On the other hand, the permanent magnets used in electrical phonograph pick-up units must be strong magnetically, but light in weight, so cobalt steel is commonly used for them.

Review Questions

1. Explain two ways in which you could prove that a magnetic field always exists around a current-carrying conductor.
2. Explain two methods of determining the shape of the magnetic field around (a) a straight wire, (b) a solenoid, (c) a horseshoe electromagnet, (d) the flux in the air gap of the loudspeaker field in (C) of Figure 1.
3. A similar coil of wire is wound on each leg of the horseshoe permanent magnet in an carphone. The coils are connected in series. Draw a diagram, marking the poles on the magnet, and show how the coils should be connected together and which way the signal current should be sent through them so that the magnetic field produced by the current will aid the field of the permanent magnet. State the rule used for determining this.
4. A 110-volt d.c. circuit is to be used to charge a storage battery through two lamps.

netized steel, (c) magnetically saturated steel.

10. If you had to wind a magnet coil for use in a circuit in which only a small current was available, would you use many turns of fine wire, or a few turns of coarse wire? State your reason!

11. The field coil of an electrodynamic speaker having a dry plate rectifier contains 1000 turns of No. 18 wire. The current supplied to it is 2 amperes at 12 volts. The rectifier is to be changed to the vacuum tube type, necessitating the rewinding of the speaker field coil. With the vacuum tube rectifier the available current will be 50 milliamperes at 300 volts. How many turns of wire will be required to produce the same magnetizing force with this arrangement? Would you use a smaller or larger size wire? Why?

12. What is magnetomotive force? What factors does it depend upon?

13. What is the objection to constructing an electromagnet with so many turns of wire on the winding, and so much current through it, that the iron core is saturated?

14. What is meant by permeability?

15. The following materials are available for use in making the core of a very strong direct current electromagnets cast iron, brass, aluminum, wrought iron, sheet steel,

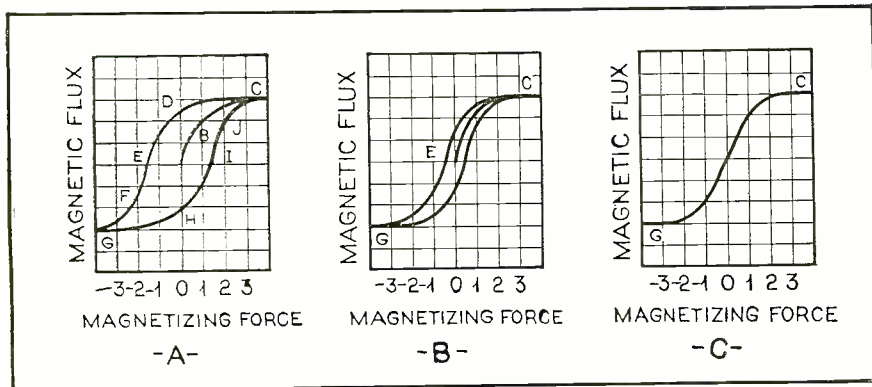

Figure 3. Hysteresis loops for (A) hard steel; (B) annealed silicon steel; (C) for ideal magnetic material having no hysteresis loss

The polarity of the line terminals is to be determined. The lamp is first connected across the line terminals and turned on. A compass needle is held over one of the wires and the direction of deflection noted. Make a sketch showing this condition. Assuming a direction of deflection of the compass needle, determine and mark the direction in which the current is flowing through the wire, and the + and - terminals of the line.

5. Is a solenoid a permanent magnet or a temporary magnet? Why?
6. How would you make a permanent electromagnet?
7. A horseshoe electromagnet is to be used to re-magnetize the horseshoe permanent magnets in earphones and loudspeaker units. If the windings are covered up so they cannot be seen, (a) How would you determine the poles on the electromagnet? (b) On the permanent magnets? (c) How would you place the permanent magnets on the electromagnet in order to magnetize them? Make a sketch.
8. Explain by means of the electron theory of magnetism, just what happens when the core of an electromagnet is magnetized.
9. Draw sketches showing the supposed arrangement of the electron orbits in a piece of (a) unmagnetized steel, (b) partly mag-

netized steel, (c) magnetically saturated steel.

16. Two parallel wires are close together and have current flowing through them in the same direction. Draw the magnetic field around each, and state whether there will be any appreciable magnetic field in the space between them. Do the same for the condition where the current in one wire is opposite in direction to that in the other wire.

17. The magnetizing coil in Figure 2 has 10 turns of wire, and an ammeter connected in series with it reads 20 amperes. The core is made of silicon steel of the dimensions shown. What is the total flux produced in the core? What would the total flux be if the core were made of (a) cast iron? (b) Wrought iron?

18. Explain in detail what is meant by hysteresis. Is it desirable to use magnetic materials having low hysteresis loss, or those having high hysteresis? Why?

19. Is it desirable to use a hard steel for the core of radio or audio-frequency transformers in which the current may vary in strength as much as 1,500,000 times a second? Why?

20. Explain the advantages and disadvantages of each of the magnetic circuit constructions shown in Figure 1.

KENYON
LABORATORY STANDARD
FLAT LINE 2A3
AMPLIFIER KIT

The Kenyon Transformer Co., Inc., announces a carefully engineered 2A3 fixed bias amplifier chassis to meet the most exacting requirements of Transmission Recording and Broadcast engineers.

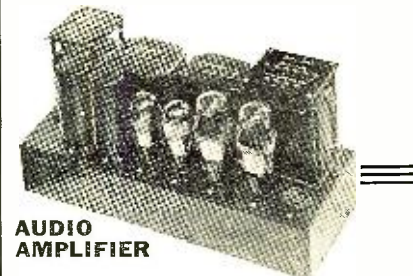

AUDIO AMPLIFIER

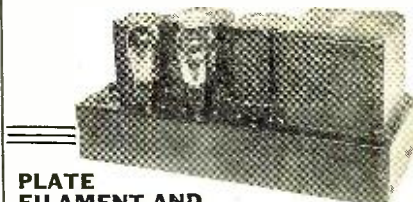

PLATE FILAMENT AND C BIAS SUPPLY

- * Excellent for use in Broadcast Stations as a studio amplifier with the new Dynamic and Velocity Microphones.
- * Specially designed to reproduce the new wide range sound film recordings without frequency discrimination throughout the entire audio spectrum.
- * Of special interest to Recording Engineers working with the new hill and dale recordings requiring amplifiers which are at least linear from 30 to 15,000 cycles.
- * Just the amplifier for public address engineers who want the finest reproduction obtainable.

TECHNICAL SPECIFICATIONS

- Input will match 17, 50, 125, 200, 250, 333 and 500 ohm lines.
- Output will match 500, 333, 250, 200, 125, 50, 15, 7.5, 4.5, 3 and 1.3 ohm lines.
- Three balanced push-pull stages. Tubes used: 2-57, 2-56, 2-2A3, 1-82, 1-83.
- Gain 97 DB.
- Frequency response linear from 30 to 17,000 cycles plus or minus 2 DB.
- Fixed C bias for output stage.
- Maximum class A undistorted output 15 watts.
- Filtering efficiency of power supply over four times greater than conventional Brute Force System.
- Audio and power supply on separate non-magnetic decks. They may be clamped on rack panels for vertical mounting or by the removal of four stud screw fasteners, each unit may be set in a horizontal case for portable use.
- All audio, filter and power transformers are hermetically sealed in high permeability cast iron shields.

KENYON LABORATORY STANDARD AUDIO COMPONENTS USED ARE:

		List Price	Dealer's Net Price
1-KLG	Input lines to P.P. grids	\$20.00	\$12.00
1-KSG23	P.P. screen grid plates to P.P. 56 grids	20.00	12.00
1-KA22	P.P. triode plates to P.P. 2A3 grids	20.00	12.00
1-KPP2A3	P.P. 2A3 plates to broadcast and voice coil lines	20.00	12.00
1-KC15-120	Trap circuit input filter choke	7.00	4.20
1-KC40-60	Trap circuit output filter choke	7.00	4.20
1-KC300-3	High impedance C bias choke	8.00	4.80
1-K2A3 PT	Plate, filament and C bias supply transformer	20.00	12.00
		\$122.00	\$73.20

Specially drilled chassis for the audio and power sections are available. A cartridge bank to hold all condensers and resistors in place is also provided. Engraved terminal input and output bakelite blocks are also furnished with the chassis assembly.

Complete set drilled chassis, cartridge bank engraved terminal bakelite blocks **\$20.00 \$12.00**
Complete transformer kit with chassis and associated components are available through authorized Kenyon distributors situated in all the principal radio centers. They will be glad to furnish you with complete information.
Full constructional engineering sheets furnished with each complete amplifier kit and chassis.

KENYON TRANSFORMER CO., Inc.
122 Cypress Avenue New York, N. Y.

What's New in Radio

A department devoted to the description of the latest developments in radio equipment. Radio servicemen, experimenters, dealers and set builders will find these items of service in conducting their work

Dual Speed Pick-Up

Description—The new Winchester Cosmophone phonograph pick-up for 33 $\frac{1}{3}$ or 78 r.p.m. records, features a new arrangement whereby the arm can be elevated to an automatic lock position, so a new needle can

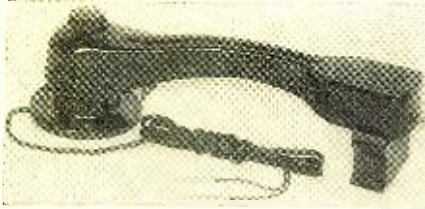

be inserted without difficulty. The pick-up is equipped with a built-in volume control and it has a micrometer adjustment for regulating pressure on the record. The pick-up head is designed to follow the tracking of the record with minimum resistance. The pick-up is complete with a cushion headrest.

Maker—Winchester Co., 36 E. 22nd St., New York City.

Power Pack

Description—The B-L Filterpack operates from 110-volt, 60-cycle a.c. supply line and delivers 6 volts direct current at 6 amperes. This is a dry type of power pack and the manufacturer calls attention to the fact that there are no moving or fragile parts, no bulbs to break or liquid to spill. It will supply the filament voltage for the new 6-volt heater type tubes used in automobile

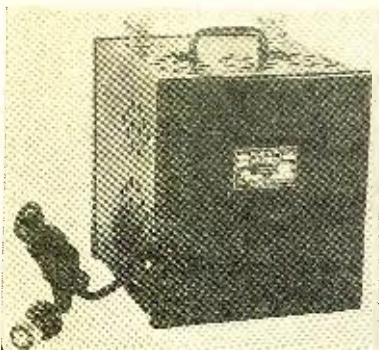

radio sets and is especially adapted for dealers' use in demonstrating display panels or for use in the service department. It is equally applicable in the home for operating automobile receivers or like circuits.

Maker—B-L Electric Mfg. Co., 19th and Washington Ave., St. Louis, Mo.

Six New Sockets

Description—Announcement is made of six new Na-ald sockets. The two units shown in the center of the illustration are 7-prong sockets to take the new small-base tubes, i.e., -2A7, -2B7, etc. The socket, upper center, is the model 437A universal mounting type, which can be mounted above or below the panel. The socket, lower center, is style 487A for breadboard mounting and has binding posts for connections. The four outside units are the new composite type sockets for modernizing set analyzers and testing instru-

By The Technical Staff

ments in adapting the equipment to the new type tubes. Model 567 socket, shown at top, left of illustration, takes all 5, 6 and the small 7-prong type tubes. The lower left unit, style 457, contacts the UY and medium 7-prong tubes. The socket at upper right, No. 477, takes all 7-prong type tubes, both the small and medium base types. Socket No. 456, shown at lower right, receives all

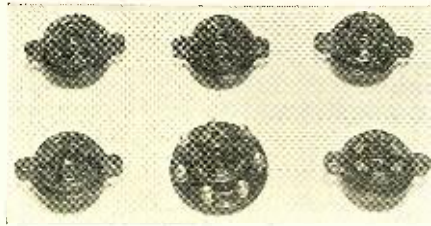

4, 5 and 6-prong type tubes. It has a common filament circuit.

Maker—Alden Products Co., 715 Center St., Brockton, Mass.

Testing Kit

Description—This handy Bank's testing kit, No. 125A, consisting of 16 pieces, should find wide application in servicing or labora-

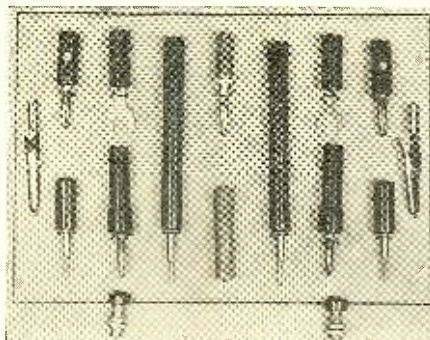

tory work. The various parts can be used in numerous combinations for all manner of radio connections and testing. The parts are non-inflammable, highly finished and polished, and are constructed to carry heavy current. The kit can be had in seven different colors and, if desired, 8-inch test prods are available with removable phonograph needles as prod points.

Maker—Bank's Inter-Air Products, Woodside, L. I., New York.

Neutralizing and Aligning Tool Kit

Description—This new ICA aligning kit should prove very popular with the radio



experimenter as well as the serviceman. It is a combination of tools especially designed for making neutralizing and aligning adjustment in all types of radio receivers. The kit comprises 12 separate and distinct parts, as follows: one alligator side wrench, a 6-inch

insulated screwdriver with metal nib, a metal $\frac{1}{8}$ -inch nut wrench, a metal $\frac{1}{4}$ -inch nut wrench, one $\frac{1}{4}$ -inch square nut insulated wrench, a $\frac{1}{4}$ -inch hexagon metal side wrench, a 2 $\frac{1}{2}$ -inch insulated screwdriver with metal nib, one $\frac{1}{4}$ -inch hexagon slotted insulated wrench, one metal screwdriver, a $\frac{1}{8}$ -inch hexagon insulated nut wrench, one 5-inch screwdriver with metal nib and a 6-inch insulated screwdriver. The various tools telescope into each other and when assembled form four units conveniently fitting into a black leatherette vest-pocket carrying case.

Maker—Insuline Corp. of America, 23 Park Place, New York City.

Resistor Kit

Description—The new International Resistance kit of small-size resistors is especially designed for use in the midget and compact

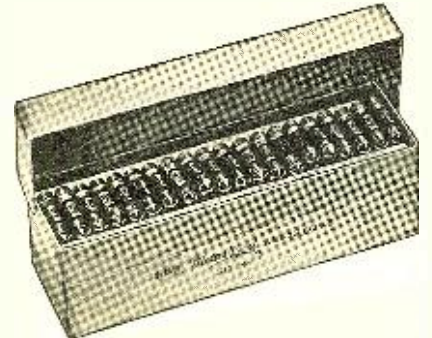

set, or for employment in any circuit where a space-saving resistor of this type is desired. This handy kit, style No. 3, contains twenty $\frac{1}{3}$ -watt metallized resistors in assorted values. The resistance values have been carefully chosen to meet the replacement demands of the most popular small-size receivers. An infinite variety of resistance ranges is possible by using the resistors in series or parallel connections.

Maker—International Resistance Co., 2006 Chestnut St., Philadelphia, Pa.

Radio Keg

Description—Following the legalization of beer, announcement is made by this company of a five-tube superheterodyne receiver

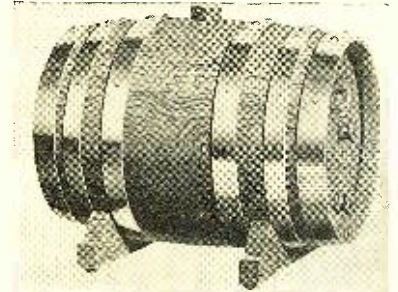

encased in a small quarter-sawn white oak, walnut finish cask. This makes a unique-looking radio set, with its striking burnished copper hoops and its ornamented copper spigot, bronze escutcheons, etc. The receiver is universal in design, operating from either alternating or direct current, and receives police calls in addition to broadcast reception. The 5-inch dynamic speaker is

mounted on the cask. The dimensions of the radio keg are: 8-inch diameter at the ends, 10 inches at center and 12 inches in length. The following tubes are utilized: one -77, one -78, one -85, one -43 and one 25Z5 type rectifier.

Maker—R. K. Radio Labs., Inc., 6300 Northwest Highway, Chicago, Ill.

Two-Button Microphone

Description—The new Lifetime Model 88, double-button carbon type microphone is economically priced, has a duralumin dia-

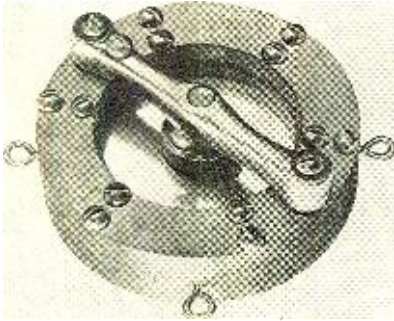

phragm .002 inch thick and is equipped with gold contact buttons. It is finished in chrome plate and the resistance is 200 ohms per button. If desired, the microphone can be furnished with a resistance of 100 ohms per button. The manufacturer states that the frequency response is between 40 and 7500 cycles.

Maker—Lifetime Corp., P. O. Box 885, Toledo, Ohio.

Compact Radio-Phonograph Receiver

Description—The RCA-Victor model RE40 is an attractive midget type combination radio and phonograph. The electric phonograph plays either the standard or long-

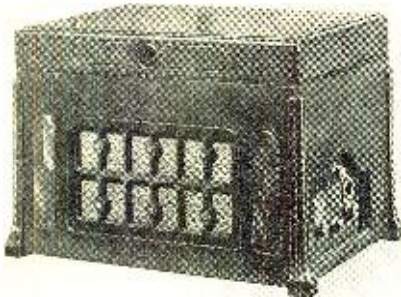

playing records. The receiver circuit is a 5-tube superheterodyne equipped with tone control and employing the following type tubes: one -58, one -2A7, one -57, one -2A5 and one -80 type rectifier. The walnut veneer, hand-finished cabinet measures 13 5/18 inches high by 17 5/8 inches wide by 13 1/8 inches deep.

Maker—RCA-Victor Co., Camden, N. J.

Portable Sound-on-Film Projector

Description—The new Victor Animatophone 16-millimeter sound-on-film portable projector is compactly designed, weighs 50 pounds and should have wide appeal for school, church or auditorium use and for numerous other applications. Operation is said to be no more complicated than with the silent machine. The sound head, comprising an exciter lamp, lens, sound gate, photoelectric cell and threading rolls, is mounted on the support base of the projector. The five-tube audio amplifier is mounted at the rear of the projector and the speaker with fifty feet of extension cord is shown mounted on one of the covers of

the carrying case. The projector can operate with silent as well as sound film.

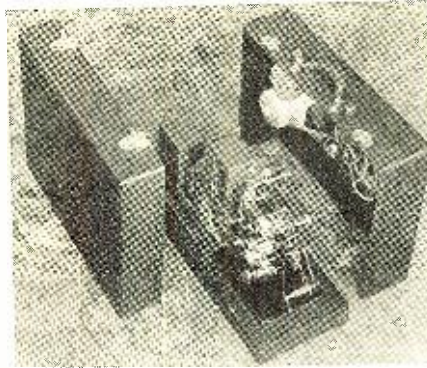

Maker—Victor Animatograph Corp., Davenport, Iowa.

Condenser Microphone

Description—The Bud condenser microphone, model 975, is designed for use in sound-picture and sound-recording studios, broadcasting stations, public-address equipment, amateur transmitting circuits or for



any of the numerous occasions where a condenser microphone of this type is desired. The microphone comprises a condenser head and a two-stage resistance-coupled audio amplifier. The duraluminum diaphragm, .001 inch in thickness, is stretched to its utmost limits by a specially designed process. The manufacturer advises that the frequency response curve of this microphone is almost flat from 32 to over 8500 cycles. The amplifier employs two -30 type tubes. The output feeds a combination 200 or 500-ohm line.

Maker—Bud Radio, Inc., 1923 E. 55th St., Cleveland, Ohio.

Universal A.C.-D.C. Receiver

Description—The new Autocrat universal a.c.-d.c. model 4 L.W. receiver employs the

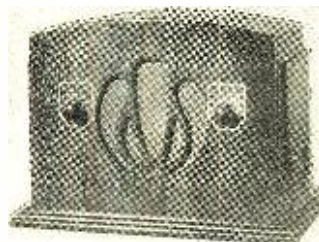

atest type tubes, which include one 6D6, one 6C6, one -43 and one -25Z5 voltage-doubler
(Continued on page 179)

Use ul Tips

From
Other Service Men

FREE.

“Sylvania News” carries a full page of practical servicing facts every month. Mail coupon for complimentary subscription.

● Here’s a way to keep up-to-date on the shortcuts other “live” service men are finding valuable in their business.

The monthly news and service bulletin, “Sylvania News,” gives you this information, as well as all the latest news in the radio and tube industries. Simply mail the coupon and the makers of Sylvania Tubes will put you on the list for a free subscription. No obligations.

Send in your own servicing tips, too. For every one that’s printed in “Sylvania News,” you’ll get a free Sylvania Tube (any type you select up to \$3.00 in value!).

Don’t miss this opportunity!

Sylvania
THE SET-TESTED RADIO TUBE



A PRODUCT OF HYGRADE
SYLVANIA CORPORATION

MAIL COUPON TODAY!

Hygrade Sylvania Corp.
Emporium, Pa.

(A-2)

Dear Sirs:

Please put my name on the mailing list for your free radio news bulletin, “Sylvania News.”

Name.....

Address.....

City.....State.....

WANT TO GET AHEAD IN RADIO?

Here is the Foundation on Which to Build Study at America's Oldest Radio School



Where Experts Teach You "Why" and "How"

NO matter what you want to learn in practical Radio . . . whether you desire elementary or advanced knowledge . . . RCA Institutes is fully prepared to give you the training.

EXTENSION COURSES FOR HOME STUDY

New "No Obligation" plan . . . Complete examination and technical advisory services. . . Free post-graduate practical training with actual modern equipment at resident school.

RESIDENT SCHOOLS AT NEW YORK AND CHICAGO

Thorough training methods . . . Extensive facilities . . . Instructing engineers of long experience in teaching radio subjects.

Illustrated Catalog on Request

R. C. A. INSTITUTES, INC.,
Dept. RN 9,

75 Varick Street, New York
1154 Merchandise Mart, Chicago

Recognized Standard in Radio Instruction Since 1909.



Dependable Sensational Performance!

... BUD Loud Speakers

5 DAYS FREE Trial

NORMAL efficiency 2 1/2 to 25 watts—peak capacity 50 watts! BUD'S new diaphragm and voice coil assembly assure higher efficiency and far greater dependability! Write for literature on BUD units, all aluminum, weatherproof "NATU-RAL TONE" trumpets, microphones, exciters, air column horns. Get details of FIVE-DAY FREE TRIAL!

BUD SPEAKER CO.
1149 DORR ST.
TOLEDO, OHIO—U.S.A.

1763 - for SERVICEMEN

Brand new EX-STAT replacement manual gives correct type volume control instantly, for 1763 set models. Most complete listing ever compiled. Copy FREE to dealers and qualified service men. Send postcard today to **TILTON MFG. CO.,** 15 E. 26th St., New York, N. Y.

INVENTORS PATENT YOUR IDEAS

Write for Free Book, HOW TO OBTAIN A PATENT and RECORD OF INVENTION—or send drawing or model for examination. MAIL COUPON TODAY!

MILLER & MILLER
REGISTERED PATENT ATTORNEYS

1638 Woolworth Building, Dept. H, New York City
206 EARLE BUILDING, WASHINGTON, D. C.

Please send me your Free Book, "How to Obtain a Patent," and your "Record of Invention Form."

Name _____
Address _____

Latest Radio Patents

A description of the outstanding patented inventions on radio, television, acoustics and electronics as they are granted by the United States Patent Office. This information will be found a handy radio reference for inventors, engineers, set designers and production men in establishing the dates of record, as well as describing the important radio inventions

By Ben J. Chromy*

1,892,924. AMPLIFYING ARRANGEMENT WITH TUBES CONNECTED IN COUNTER CADENCE. JUSTUS BABLER, Berlin, Germany, assignor to Allgemeine Elektricitats-Gesellschaft, Berlin, Germany, a Corporation of Germany. Filed Sept. 11, 1929, Serial No. 391,760, and in Germany Oct. 13, 1928. 3 Claims.

1. The combination of a push-pull amplifier and a resistance network adapted to be

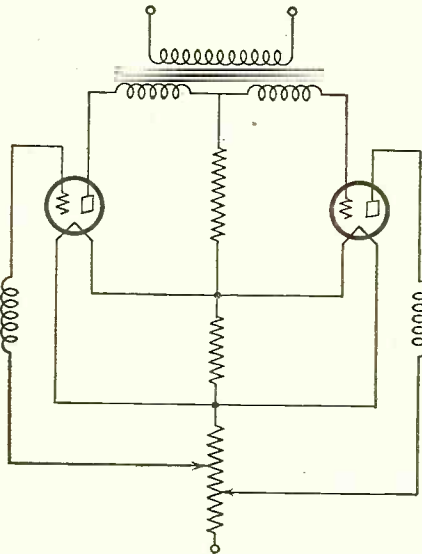

connected in parallel with a direct-current source, means for connecting the filaments of said tubes in parallel with each other and with a portion of said network, means for connecting the normal tendency to project from the plane of the slide, the slide being recessed to allow the tongue to lie in the plane of the slide.

1,856,223. ANTENNA REEL. CARLOS B. MIRICK, Washington, D. C., assignor to National Electrical Supply Company, Washington, D. C., a Corporation of Virginia. Filed July 30, 1929. Serial No. 382,234. 5 Claims.

1. An antenna reel for aircraft radio communication systems comprising in combination with an antenna wire, a reel of insulation material for receiving said antenna wire in coiled form thereon, a support for rotatably mounting said reel, a braking device carried by said support and positioned adjacent said reel, said braking device having a plurality of stop positions, means carried by said reel for engaging said braking device at a selected stop position, and an electrical connection between the antenna wire on said reel and said means, said connection being completed through said braking device when said means on said reel is engaged with said braking device for fixing the position of said reel with respect to said braking device.

1,894,794. DOUBLE-ACTION VOLUME CONTROL. ALEXANDER SENAUCHE, New York, N. Y., assignor to King Manufacturing Corporation, Buffalo, N. Y., a Corporation of New York. Filed July 3, 1929. Serial No. 375,669. 7 Claims.

1. In an amplifier system in combination, a thermionic vacuum tube, a source of anode potential, a path through which the anode current flows, a second path through which current flows from the source of anode potential, a resistance in said second path, and a resistance common to both said current paths, means for applying the voltage drop across said two resistance as a bias potential to the grid of said vacuum tube, an input circuit associated with said vacuum tube, a third resistance in shunt with said

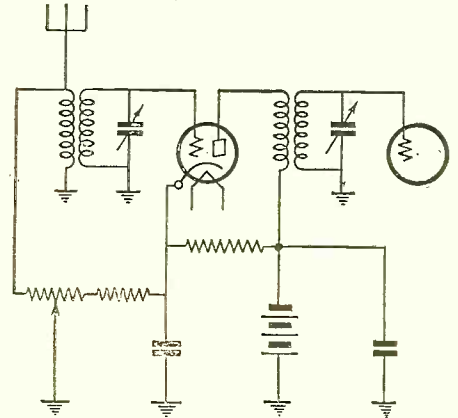

input circuit, and means for simultaneously varying said last-named resistance and said common resistance.

1,884,536. RADIO SIGNALING. WILLIAM R. BLAIR and LOUIS COHEN, Washington, D. C. Filed Nov. 24, 1928. Serial No.

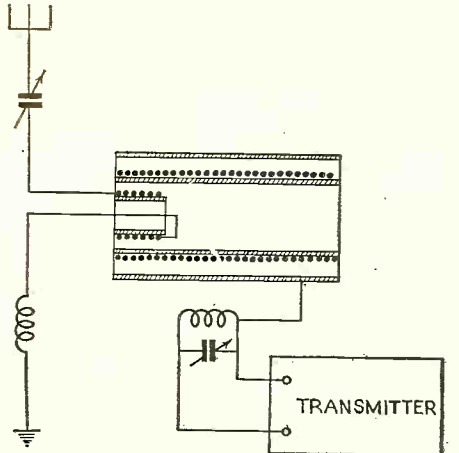

321,688. 4 Claims. (Granted under the Act of Mar. 3, 1883, as amended Apr. 30, 1928; 370 O. G. 757.)

* Patent Attorney, Washington, D. C.

1. In a system for the transmission of radio signals comprising an oscillation energy source associated with an oscillating circuit, a wave conductor with an antenna, said wave conductor comprising a wave coil and a metal shield in proximity thereto, said oscillating circuit being connected at one point to said metal shield, said wave coil being open at both ends, a coupling coil which is coupled to said wave coil being connected in series in said antenna.

1,881,395. RADIO RECEPTION. WILSON AULL, Jr., Astoria, N. Y. Filed Dec. 30, 1927. Serial No. 243,661. 5 Claims.

1. A system of household broadcast reception, which comprises means for receiving

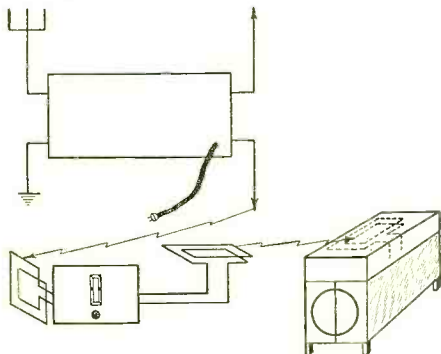

and simultaneously amplifying with substantial uniformity various frequencies within a predetermined band of frequencies, separately portable means for selecting signals of the desired frequency and amplifying the same to a controlled extent, means for transmitting the amplified and selected signal at its original frequency and an aperiodic receiver including means for picking up and demodulating the transmitted signal and further amplifying the same at audio frequencies, and means for reproducing the further amplified signals.

1,871,994. LIGHT-SENSITIVE DEVICE.

HARLEY A. IAMS, Wilkingsburg, Pa., assignor to Westinghouse Electric & Manufacturing Company, a Corporation of Pennsylvania. Filed Jan. 18, 1929. Serial No. 333,470. 3 Claims.

3. In combination, a light-sensitive device having an anode and a cathode, a condenser,

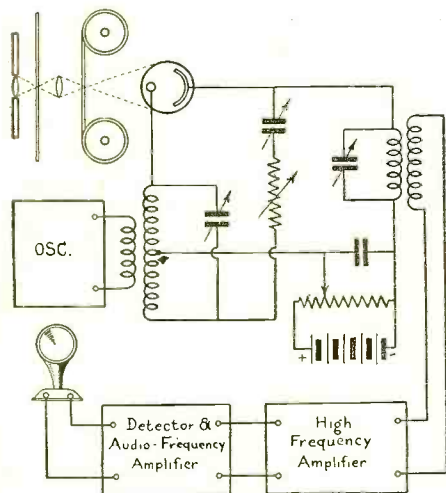

a resistor and an oscillatory input circuit connected serially between said anode and said cathode, an oscillatory output circuit and a potential source serially connected between one of said electrodes and a point on said input circuit, means for impressing oscillatory energy upon said input circuit, and means for deriving light-modulated energy from said output circuit.

Meter Rectifiers

(Continued from page 151)

such overloads as might be occasioned by an inadvertent attempt to measure a shorted condenser.

In view of the fact that the ohmic reactance of a condenser is a function of the frequency of the applied a.c. values, the suggestion may be advanced that frequency variations in the line will introduce errors in the meter indications.

The analyzer cable circuits of the model 333 tester are indicated in Figure 6, in which it will be observed that each of the circuits, except the filament or heater circuits, is provided with a pair of insulated pin-jack terminals with a normally closed push-button switch between the pin-jacks. Potential and resistance measurements are accomplished across the cable circuits by connecting the desired meter function and range for these respective purposes. Current measurements are accomplished by connecting a milliammeter range into the desired circuit, after which the push-button switch should be opened by depressing the corresponding button. Similarly, the self-contained battery of the tester may be connected into any one of these circuits for tube-testing purposes. This terminal arrangement enables the connection of other elements, such as "pick-up" devices, microphones, headphones, grid leaks, etc., for numerous other special tests; or, if desired, the terminals of a transformer may be connected to the pin-jack terminals for using the tester as a tube checker with a.c. power supplied independently of an operative radio. This arrangement also eliminates the necessity for using troublesome output adapters when it is desired to utilize the tester for output measurements, as it is only necessary to connect the desired a.c. voltmeter range across the plate and cathode circuits with the analyzer plug inserted in the power output stage of a radio while the power tube is placed in the proper analyzer socket. The condenser C5 of Figure 4 effectively "blocks" the d.c. plate potential, so that the meter indicates only the a.c. component of the output signals. A further study of Figure 6 indicates that the cable conductors, the pin-jack terminals, the socket terminals, and the switches are designated by the new RMA numbering system, and that when the analyzing plug is inserted in a radio socket the circuits of that socket are extended to the analyzer panel for any measurement which may be desired, so that it is unnecessary to remove or to dismantle a radio chassis in order to gain access to the circuits for the usual "point-to-point" tests with test probes, as is necessary with the usual multi-purpose meter. Furthermore, it is not necessary to make complete point-to-point tests with this tester. Instead, by utilizing a tester of this type to progressively analyze the circuits of a radio for plate current readings until a socket is encountered at which normal plate current values are not indicated, and then making point-to-point or resistance tests in this portion of the circuit, radiomen can conserve their time to a great extent.

Since all of the circuits of a radio tube socket are extended to the analyzer panel, the potentials of these circuits may be used for the purpose of testing individual units, such as capacitors, resistors, etc. Most modern radios are so designed that a d.c. potential of 250 volts is applied to the power tube, and this potential is ideal for condenser leakage tests when employed in series with the 250-volt range of the d.c. potential-measuring functions of the tester. Similar connections may be made for leakage tests of electrolytic condensers, if the proper polarity relations are observed when making the connections.

THESE MODERN TESTERS are...

✓ more accurate!
✓ more flexible!
✓ more economical!



No. 506

Readrite Ohmmeter

THIS handiest instrument of the service man can have on his bench or in his tool box... for continuity and resistance testing. Simply designed, easy to operate... it is very accurate in its results. This instrument has two scale readings: 0-500 ohms... and 0-50,000 ohms. The low range is used for testing voice coils of dynamic speakers, shorted turns of i.f. transformers and other resistances below 300 ohms. The high range is suitable for general resistance continuity testing. (These scales can easily be increased by using additional resistors and batteries at only a small additional cost.) Equipped with Triplett Moving Coil instruments and 1½ volt battery.

Only \$7.80 Net to Dealers
List \$13.00



No. 550

Readrite Oscillator

This signal generator furnishes a modulated signal of constant frequency for the alignment of all modern radios. The Readrite No. 550 Oscillator is one of the serviceman's most important instruments. It is used to align r.f. gang condensers, locate defective r.f. transformers, adjust i.f. transformers, check oscillator stage, compare gain in tubes and determine the sensitivity of a receiver. Harmonics of the broadcast frequency can be used to check short wave converters and short wave sets. Covers entire broadcast and intermediate bands. The tuning dial is direct reading for intermediates of 120-185 KC and 550-1500 KC broadcast range.

Only \$21.00 Net to Dealers
List \$35.00
(Complete with Output Meter)

Never before have you been able to buy such dependable, thoroughly practical, quality instruments—at so low a price. Thousands of expert servicemen, dealers and experimenters throughout the world use and endorse Readrite instruments. Your jobber can supply you. Make your tester dollars go further. Send the coupon today.

READRITE METER WORKS
70 College Ave., - Bluffton, Ohio

MAIL THIS COUPON TODAY
READRITE METER WORKS,
70 College Avenue, Bluffton, Ohio.
Gentlemen:

Send me information about No. 506 Ohmmeter
 No. 550 Oscillator
Also catalog of other servicing instruments.
Name.....
Address.....
City..... State.....

What's New IN AUTOMOBILE RADIO

With summer and the vacation touring season upon us, a multitude of car owners are contemplating radio installations. Brief descriptive data is given here on a number of the newest models, showing important new developments

Improved Type of Remote Control

Description—The Motorola Model 77, shown in the first illustration, is a seven-tube superheterodyne. The B supply and the receiver chassis are enclosed in the same metal case. The manufacturer calls attention to the absence of motor interference

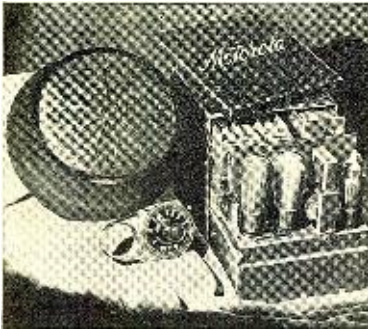

pickup, which he states is due to the use of the Eliminode filter system, a new development to eliminate the necessity of external shielding. The tubes employed are: four -39 type, one -75 type and two -L.A. type. The receiver measures approximately 8½ inches by 8 inches by 7 inches. The second illustration is on the Motorola Model 55, five-tube superheterodyne motor-car set. The receiver chassis, B supply and the loudspeaker are all combined in the one housing. This receiver makes use of the following type tubes: two -78, one -77, one -75, and one

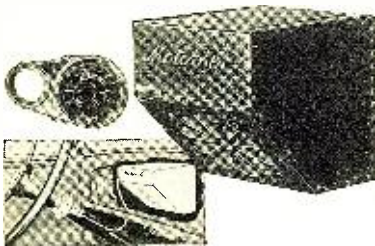

L. A. type output power tube. Each of these models features automatic volume control, dynamic type speaker and a new airplane style one-button control and station selector. To prevent back lash a worm-drive synchro-mesh principle is employed in the remote control system. Easy installation and easy removal of the chassis for quick service are other features.

Maker—Galvin Mfg. Corp., 847 W. Harrison St., Chicago, Ill.

Self-Contained Auto Set

Description—The Philco Transitone Model 5 single-unit automobile receiver is combined with the B eliminator and loudspeaker in one metal container measuring 7½ inches by 6¾ inches. The set is designed for ease of installation and operation. It is equipped with automatic volume control and a special tuning gear to prevent car vibration detuning the set. This is a five-tube superhetero-

dyne circuit employing the following tubes: one 6A7 type as combined detector and oscillator, one -78 type as an intermediate-

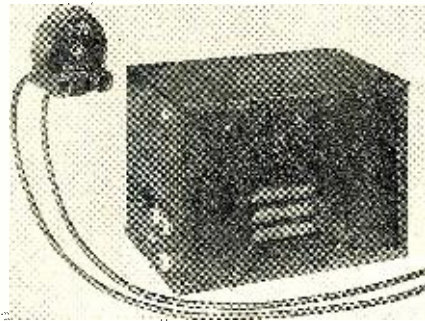

frequency amplifier, one -75 for second detector and automatic volume control, one -41 type power tube for the output stage. The -84 type rectifier is used in the power supply.

Maker—Philco Radio & Television Co., Tioga and C Sts., Philadelphia, Pa.

Direct-Control Receiver

Description—This manufacturer introduces the new Lafayette motor car receiver featuring compact design, simplicity of installation and attractive appearance. The receiver chassis, B power supply, reproducer and the controls are all contained in the one housing, which measures 12 inches by 6¼ inches by 5½ inches. The receiver is operated directly from the chassis. For those who wish remote tuning, a control head is available and is easily clamped to the steering post. This is a six-tube superheterodyne circuit and the vacuum tubes employed are as follows: one -77 type as first detector and oscillator; two -78 type for the r.f. and i.f. amplifier stages; one -75 as second detector and first audio-frequency amplifier; one -41 type for the power output stage and one -84 type rectifier. The receiver is so designed that it may be hung on brackets from the underside of the instrument board or it may be placed on the floor alongside the



driver's seat. The current consumption of this receiver is approximately 4.35 amperes.

Maker—Wholesale Radio Service, 100 Sixth Avenue, New York City.

Single-Unit Receiver

Description—The new Emerson Model 678 automobile receiver is designed for easy installation, simplicity of operation and low battery drain (4.5 amperes). The chromium-plated case, measuring only 8 inches by 7 inches by 6 inches, houses the receiver chassis, B supply and a full electro-dynamic type reproducer. The set fastens to a three-hole mounting bracket by means of two wing-nut thumbscrews. This type of mounting design makes a simple matter of servicing the receiver or checking the tubes. The receiver is a five-tube superheterodyne circuit using the following type tubes: one -78, one -6A7, one -6B7 and two -41 type power tubes. Additional features of the set include automatic volume control, tone compensation, automatic noise suppression, a tubeless B power supply, a power output of 4 watts

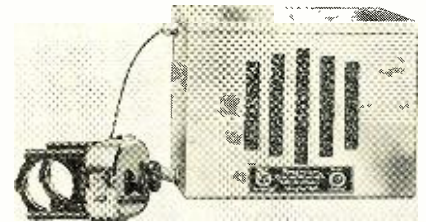

and steering-column type control unit with a protective fuse and illuminated tuning dial. The receiver is also adapted to motorboat installation.

Maker—Emerson Radio and Phonograph Corp., 641 Sixth Ave., New York City.

Superheterodyne Motor Car Set with Built-In Power Supply and Speaker

Description—The new Acratone "Road King" five-tube automobile receiver is stur-

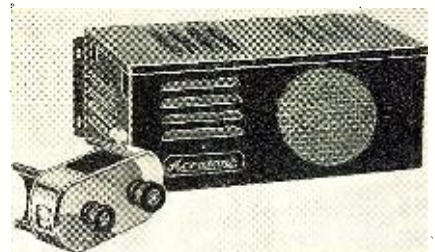

dily constructed to withstand excessive road shocks. The chassis is made from rust-resistant steel and the cabinet has an attractive crackle finish. The 5-inch dynamic type speaker, B eliminator and receiver chassis are all contained in the single case which measures 13 inches by 6 inches by 5 inches. The receiver takes advantage of the new types of vacuum tubes, which include one -6A7, one -78, one -75, one -42 and one -84 full-wave rectifier. Automatic volume control is made possible by the employment of the new -75 diode-triode type tube used in the second detector stage. The remote-control unit fastens to the steering column. The

set is designed for quick and easy installation in any make of motor car. It may be placed on the floor-board alongside of the driver's seat or it can be suspended on brackets from the underside of the car's instrument control panel.

Maker—Federated Purchaser, Inc., 25 Park Place, New York City.

What's New in Radio

(Continued from page 175)

rectifier. This receiver is made to operate on 110-125 volts, direct or alternating current (25 to 60-cycle) line supply. The set is equipped with dynamic type speaker, a self-contained aerial and has a tuning range from 175 to 550 meters, which takes in the police calls in addition to the regular broadcast band. The shipping weight of the receiver is 12 pounds.

Maker—Autocrat Radio Co., 3855 N. Hamilton Ave., Chicago, Ill.

Servicing Receivers

(Continued from page 153)

tubes and circuit layouts, you will have no difficulty in going right down the line, checking voltages so quickly that it will amaze you. The need for an adapter is eliminated.

Both in the home and in the shop, it is wise to tune in a broadcast station and analyze the audible response for a characteristic sound which gives a clue to the possible trouble. You should develop the ability of going from effect to cause. With experience, this may even eliminate the need for a stage-by-stage breakdown procedure.

The modulated signal generator with its positive output level control permits rough checking of the sensitivity of the receiver. With a low setting of the oscillator attenuator control, a fairly low r.f. output is obtained. From experience you will be able to tell whether the amount of receiver output obtained with this setting is satisfactory. Thus you know whether the machine is sensitive, insensitive or fair; that is, the overall sensitivity of the machine is checked. The selectivity may also be checked by leaving the oscillator at a given setting and tuning the receiver off resonance. If the machine does not come up to expectations, realignment of the tuning stages will improve sensitivity and selectivity. There is no need of going into the method of realigning receivers, as this is a procedure that most servicemen know or can quickly learn.

Tracing Noises

By means of simple socket adapters, certain types of intermittent noise and reception may often be traced down. Set the machine in operation, connecting the milliammeter in the supply circuit of the suspected stage. When the break in reception is heard, the milliammeter is checked to determine whether it's in that stage. Or with the output indicator connected, the oscillator connection may be advanced until steady readings are obtained. Once located, all parts in that particular stage are under suspicion and are carefully checked electrically or by substitution.

Let me repeat that the detailed technique cannot be expressed in a single article, but if you develop the habit of going directly to the location of the fault by means of the elimination method; then apply the usual isolation technique; make the necessary repairs or replacements and revitalize the receiver by any of the standard or special procedures; you will find that changes in tubes and circuits will no longer concern you.

PRECISION-MADE FOR SHORT-WAVE WORK



AIR-DIELECTRIC TUNED I. F. TRANSFORMERS

Designed with Velvet Vernier micrometer tuning. . . . All peaking adjustments from top of coil, self-locking rotors, isolantite insulation. . . . New type Litz coils. . . . 450 to 550 kc. range. . . . Variable mutual inductance. . . . U. S. Pats., Nos. 1,656,532; 1,713,146. Others pending.

SW-3 AMATEUR RECEIVER

The famous NATIONAL Thrill Box, made for amateurs. High signal-to-noise ratio. . . . High R. F. gain through use of '58 tubes. . . . Genuine single control. Because original tooling and engineering cost is now written off, the SW-3



is offered at new low list of \$24.50, less coils. Band spread coils, \$4.75 per pair. Full line of standard R-39 coils for complete coverage from 9 to 2000 meters. (Usual trade discounts apply.)

EMP CONDENSER

A split-stator condenser for receivers and low power push-pull transmitters. Isolantite stator insulators, 1200 v. Single spaced. Standard size 100 mmf. per sect. Available up to 350 mmf. per sect.



BX VELVET VERNIER DIAL WITH VERNIER INDEX



Has standard NATIONAL Velvet Vernier B-Dial drive, variable ratio, 6-1 to 20-1, —and with new Vernier Index reading accurately to 1/10th division. Ideal for service men's oscillators, etc.

TYPE R-152 RADIO FREQUENCY CHOKE



Isolantite insulation on metal base, —10,000 v. insulation, continuous universal winding in 5 tapered sections; inductance 4 m.h.; distrib. cap, 1 mmf.; DC resistance 10 ohms; current ratings: —continuous 0.6 amp., intermittent 0.8 amp. For both high and low powered transmitters and laboratory oscillators.

TYPE R-100 R. F. CHOKE

Isolantite mounting, continuous universal winding in four sections. For pistol connections or standard resistor mountings. Ind. 2 1/2 mh.; distrib. cap., 1 mmf.; DC resistance 50 ohms; Current ratings, 125 M.A. For low powered transmitters and all types of high frequency receivers.



NATIONAL SOCKETS

Isolantite coil and tube sockets, glazed upper surface for sub-panel or base mounting in 4, 5, 6 or 7 prong types. Exclusive locator-groove makes tube insertion easy.



MIDGET CONDENSERS

NATIONAL makes a full line of midget condensers for short and ultra shortwave work. Send for special Bulletin giving specifications and prices.



NATIONAL PRECISION SHORT-WAVE PARTS AND RECEIVERS

NATIONAL COMPANY, INC.
61 Sherman Street
Malden, Massachusetts

Gentlemen:
Please send me your latest 16-page catalogue. I enclose 6 cents to cover mailing costs.

NAME.....ADDRESS.....
RN-9-33

MASTERDIAL

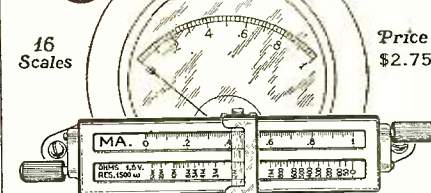

16 Scales Price \$2.75

MASTERDIAL—INSTALLED ON YOUR 0-1 D.C. MILLIAMMETER ENABLES YOU TO READ SIXTEEN A.C. AND D.C. VOLTAGE, RESISTANCE AND CAPACITY RANGES INSTANTLY AND ACCURATELY.

CALIBRATED FOR USE WITH STANDARD 4 MA. METER, WITH OR WITHOUT TAU-REX RECTIFIER, WHICH MAKES AN A.C. VOLTMETER OUT OF ANY MILLIAMMETER. ALSO CALIBRATED FOR UNIVERSAL METER.



Also See Finest Worked Plugs Made
BANKS INTER-AIR PROD.
WOODSIDE, N. Y.
Sole Distributor Leo Taussig Prod.

DON'T PUT IT OFF!

Classes Start Sept. 15th
**ONE YEAR
RESIDENCE COURSE**

in
Practical Radio Engineering

Be among the first to take advantage of this thorough Residence Course. Registrations must be in immediately—classes limited in size. (If nearby see special Summer class now in session.)

COMBINATION HOME-STUDY RESIDENCE COURSE!

A special complete course that combines the regular home-study plan and a P. G. Residence Course at small additional cost.

CAPITOL RADIO ENGINEERING INST.
14th and Park Road, Washington, D.C.

Dept. R.N.-9

Send for New

● **FREE CATALOG** ●



?QRD?

*A column devoted to
the commercial opera-
tor and his activities
Conducted by GY*

A NEW and more intensive U. S. Weather Bureau service, for the collection and dissemination of information to ships in and near the affected areas, about hurricanes at sea, is being inaugurated through the aid of the R.M.C.A. This announcement comes prior to the annual hurricane season and it is expected that the new service will be a distinct contribution to the safety and comfort of voyagers who traverse the hurricane regions at this time. It will enable navigators to avoid these disturbances. The new program provides that weather reports shall be received as frequently as necessary when a hurricane is in progress from ships known to be in water areas from which observations are urgently needed. The Radiomarine coastal stations through which such messages will be handled are located at Palm Beach, Tampa, Port Arthur and Galveston. Messages may be requested hourly by the Weather Bureau to enable them to make up precise charts for transmission to ships at sea.

As has been noted before in this column, in reference to operators using "bugs" on the air, a letter has been received from an English brother anent same and to-wit: "... and now here is a question on which I would like to hear the opinions of American ops. Why is the sending of so many American stations transmitting PX messages so dreadfully on the bum? The dope is good, the power ditto, but the quality of the operating is fierce. Listen in from midnight G.M.T. to 'round 3 a.m. and you will get what we mean. (Ed. Note: Don't we know what he means!) There are guys working bugs who send dots corresponding to about 50 w.p.m. and dashes at a rate of about 20 w.p.m., putting the whole show out of balance. At long distances, when conditions are bad, it easily doubles the difficulty of delivering clean copy if the receiving op has to sub-edit the dope as received. 5's instead of h's and 6's instead of b's, and so on, make PX time a regular ordeal. . . ." Just a lot of power and effort wasted, sez we, especially when requested repeats are asked for.

A new metal tube has just been brought out on the market by a British firm which they contend will last until the filament burns out. It is unbreakable! Shades of the *Utah* when one of the gang carried a 1 kw. water-cooled bottle and someone asked him for a match and the gadget hit the deck with a splash! Instead of using glass for its envelope, the new tube maintains its vacuum within a metal sheath which in turn is enclosed in an outer metal guard sheath, like a thermos bottle. These new tubes are said to radiate heat more rapidly, which increases the operating efficiency greatly.

A little news item brings to our attention the case of the little cobweb that interrupted telegraph service between Detroit and Chicago. No lines broken, bats OK, everything in perfect order—but still no juice. One of the shooters happened to notice an old dusty

cobweb stretching from one of the key posts to the other, and it was found that at nightfall the bloomin' web absorbed moisture which created the short-circuit. Which brings to memory the time a brand-new 2 kw. xmtr was installed aboard the *Mary Nan* and it just wouldn't perk. Everybody, from the skipper down to the mess boy, had their hands on the blue-prints, trying to see what the answer should be. They tried talking to it and then shaking it, but still it was obstinate, until one bright boy noticed that the ground wasn't connected. Just one of those things, you know.

In reference to our request for information as to the originality of the "hoss-laff" MIM, the controversy, as far as we are concerned, is cleared up by a unanimous statement that the British brethren were the first to employ it. "HI" seems to be our own idea of a *raspberry*. From amongst the batch of replies, we print these:

"... Back in 1909, when Buck Chetham was selling perikon detectors to those who had only the magnetic, and Capt. Hartshorn of the army was better known as Sarge, the haw-haw signal was used extensively by our cousins across the sea. However, if memory serves me right, the signal was not sent as a unit, but as three letters, 'MIM.' By observation, there is readily discernible evidence that our coarse Yankee HI was too boisterous for the reserved and taciturn sons of Albion, Caledonia or points east. Therefore, the more refined and cultured MIM was used by the boys with a background of Buckingham, Westminster or Grey's Inn. . . ."

"... During 1910 and 1911 most of the gang used the HI and HA, repeated twice, to signify a laugh or to slip another op the gentle raspberry. If I can remember correctly, a British Post Office op named Ledbetter arrived on the Coast on a new C. P. R. vessel from the Alaskan run. This man was the first I ever heard use the high-power warning signal MIM to signify the laugh. Up to the time Ledbetter came there were few Marconi sets, and the old United Wireless supplied most of the ops who came from the wire lines. A number of wire men soon followed Ledbetter and I noticed that all of them used the MIM signal for the same purpose. Of course, this was before the day of international agreements on the use of the radio alphabet and there was no official designation of MIM as a high-power warning." So-o-o! we hope the boys in the back room at R.M.C.A. will know now who started it all!

Here's something for the old prosperity gag. The R.M.C.A. has just been awarded the contracts for the 67 ships of the Lykes Brothers combined steamship interests; 25 of the vessels will be equipped immediately with R.M.C.A. emergency xmters and complete standard equipment is being purchased for seven more. Radio service is included for all. Also, the United States Lines have contracted for radio service for 10 of their ships, including the *Leviathan*. So stand up, you buzzer-room luzzards, and keep the old eustachian tubes peeled for that signal.

Aboard the *Conte Di Savoia* we find that there are seven ops employed to take care of the heavy telegraph and telephone communications and apparatus while she is at sea. Recently, Chief Radio Officer Pinnachi kept in constant communication with the home office at Genoa, via the radio-telephone apparatus aboard, during the run from there to New York City. Greatest distance, when she reached port here, was 4000 miles. He sez his 18 kw. xmtr, if opened wide, would be able to communicate with any part of the world. In addition to this xmtr, there are three other telegraph xmters

which employ wavelengths above 1000 meters. The waves used for telephone communication work are 17, 23, 35 and 69 meters, depending upon the time of day.

It seems that all the owners of broadcasting stations are interested in is a clear channel, contracts and higher power, and we are wondering what will happen to the wave allocations of the different nations when all these stations who are shouting for higher power receive it. And what will happen to those secondary stations which depend upon the picking up of programs from the "Mother" stations for rebroadcasting? Will these latter be put out of commission and off the air? Or will they themselves receive higher power grants and help to clutter up the atmospherics which are at the present time so thoroughly congested that Canada, Mexico, Cuba, etc., are going into a huddle shortly to receive adequate and equal allocations for their stations? Will there come the time when there will be an insufficient number of waves left for even the amateurs to play in? And what is the reason for these requests for higher power? Is it to increase the listener percentage, or is it due to the pride of ownership to say that we have a greater power station than the next one? Whatever it is, we cannot see why, with subsidiary stations to rebroadcast programs and with stations capable of stepping up short-wave receptions from foreign countries for rebroadcasting, this mania for power should be permitted to congest the air so that eventually there will be a hodge-podge of clamor such that listeners won't even tune for a station, as the present broadcast receivers are not selective enough to separate stations completely. It might even prove a boomerang to those stations now crying for power and who need the listeners-in.

This month, the desk has been polished with mail from various parts, and many thanks go out from Ye Ed, 'cause we would sure be in a fine fix in passing on the dope without the help of the gang. Amongst these we note that Ketchikan, Alaska, through the help of Brother W. B. Wilson, who is now watching the waves from the Lighthouse Tender *Fern*, passes on 73 to the gang. . . . From Hazleton, Pa., comes word from B. Z. Walleze, W8BQ, who wants to hear from some of the old side-swipers. . . . K. L. Moran has turned into a serviceman and is knocking em dead with his yarns, incidentally doing a nice little business on the side. . . . And there is the one from Eisenstadt, who wants plenty of info but has forgotten to put his return address on the envelope. . . . Now is that nice or just plain foggy? . . . And again we hear from the indefatigable "HC" who is still messing around with the authorities up Massachusetts way, who sez that hearing from his Civil War veteran pals from way back in 1897 when he was putting squeals on the air, would make him gain a few years of life. . . . Then Larry Briggs, from *Mohawk*, sends greetings, but without dues, and sez he is now writing to his Congressman to sit on the lid when the bill comes up. . . . And there— But space is getting short, so we'll save the rest for the next episode and until then, 73 and cheerio from GY.

P. P. Amplifier

(Continued from page 147)

at all input and output impedances.

All grid, plate and cathode circuits are filtered to prevent interstage feedback and parasitic oscillations.

The amplifier, as constructed, is in two sections, one for the power supply and one for the audio section. This allows a maximum separation of the two units, minimizing

pick-up from stray electrostatic and electromagnetic fields. A 7-prong cable is used between the units. The general construction allows the amplifier to be used for either vertical rack mounting or for horizontal mounting in oak cases.

(To make sure that experimenters and sound engineers intending to build this amplifier obtain maximum results, the Kenyon Transformer Co., Inc., has made available a limited number of stamped chassis for the



MOUNTED IN RACK
Amplifier and power unit installed in rack frame

fixed-bias 2A3 amplifier. If these chassis are employed, it is imperative to use the specified type of audio units, condensers, resistors and sockets. The chassis will fit the standard 7-by-19 rack panels if used for vertical mounting.)

Parts List

- C1, C2, C3, C4—Aerovox electrolytic condensers, type P5-2, 2 mfd., 500 volts
 - C5, C6—Aerovox electrolytic condensers, type P5-4, 4 mfd. 500 volts
 - C7—Aerovox electrolytic condenser, type P5-1, 1 mfd., 500 volts
 - L1—Kenyon filter choke, type KC15-120; bottom mount
 - L2—Kenyon filter choke, type KC40-60; bottom mount
 - R1—IRC resistor, 250,000 ohms, 1 watt
 - R2—IRC resistor, 1000 ohms, 1 watt
 - R3—IRC resistor, 50,000 ohms, 1 watt
 - R4—IRC resistor, 1350 ohms, 2 watts
 - R5—IRC resistor, 5000 ohms, 2 watts
 - R6—IRC resistor, 50,000 ohms, 1 watt
 - R7—IRC resistor, 50,000 ohms, 20 watts
 - R9—IRC resistor, 10,000 ohms, 2 watts
 - T1—Kenyon input transformer, type KL2G; bottom mount
 - T2—Kenyon interstage transformer, type KSG23; bottom mount
 - T3—Kenyon interstage transformer, type KA22; bottom mount
 - T4—Kenyon output transformer, type KPP2A3; bottom mount
 - T5—Kenyon power transformer, type KPT2A3; bottom mount
 - 2 Eby six-prong wafer sockets
 - 3 Eby four-prong sockets, No. 12
 - 2 Eby five-prong sockets, No. 12
 - 2 Eby small type seven prong sockets, No. 12
 - 2 Kenyon special drilled chassis, each 16½ inches long, 6½ inches wide and 3 inches high, outside dimensions
- PARTS FOR FIXED BIAS SUPPLY**
- C9—Aerovox electrolytic condenser, type P100-50, 50 mfd., 100 volts
 - C10—Aerovox electrolytic condenser, type P200-10, 10 mfd., 200 volts
 - C11—Two Aerovox electrolytic condensers, type P5-4, 4 mfd., 500 volts
 - L3—Kenyon filter choke, type KC300-3
 - R10—IRC resistor, 10,000 ohms, 2 watts
 - R11—IRC resistor, 60,000 ohms, 5 watts
 - 1 Eby four-prong socket, No. 12
- PARTS FOR SELF-BIAS**
- C8—Aerovox electrolytic condenser, type P200-25, 25 mfd., 200 volts
 - R8—IRC resistor, 700 ohms, 10 watts

VALUE . AND . ECONOMY
The Lowest-Priced
COMPLETE
Short-Wave
Superheterodyne



COMET
"PRO"
Professional
Short-Wave
Receiver

Mail Coupon for Details

TO own a short-wave receiver comparable with the COMET "PRO," you must buy or build a perfect tuner, an adequate power supply, a complete set of coils, special transformers, etc. These will make your receiver cost more than if you bought the "PRO" complete, with all "accessories" built-in and scientifically matched to the receiver.

The list price of the COMET "PRO" is \$150 (less tubes). But it won't cost you that much! As a recognized amateur you are entitled to a discount of 40 and 2 percent, which reduces the price to \$88.20, plus a small Federal Excise Tax. That price includes not only a tuner, world-famous for its sensitivity and selectivity, but also a built-in power pack, air-tuned transformers, and all coils needed to cover a range of 15 to 250 meters, with band-spread tuning at all frequencies.

Think it over and you'll buy the COMET "PRO" for its unexcelled performance, plus its unequalled value and economy.



HAMMARLUND MANUFACTURING CO.,
424-438 W. 33rd Street, New York, N. Y.
— Check here for COMET "PRO" booklet.
— Check here for General Catalog "33".

Name.....
Street.....
City & State.....RN-9

Free!

"Short Waves" by Leutz
with
9 issues Radio News at \$2

REALIZING that many of our readers are seeking the thrills of short-wave reception, Radio News now offers, absolutely free, one of the best books on short waves ever issued!

"Short Waves" by Chas. R. Leutz and Robt. B. Gable is a 384-page, cloth-bound book with innumerable illustrations, written in clear, understandable language.

It contains chapters on: Short-Wave Propagation; Commercial Radio Telephony and Telegraphy; Ship-to-Shore Radio Telephony; Directional Antennae; Television; Aircraft Radio Equipment; Short-Wave Broadcast Receivers; Ultra-Short Waves; Amateur Short-Wave Equipment; a Historical Review of Radio; and a barrel of other valuable information.

Every short-wave enthusiast needs this book. Mail \$2 today and get the next nine issues of Radio News and your free copy! (Canada \$2.55 —Foreign \$2.50.)

Dept. 9B
Radio News
222 West 39th St.
New York, N. Y.

5 WATT
110 VOLT A.C. DC
AND 6 VOLT D.C.
UNIVERSALLY
OPERATED
PORTABLE
AMPLIFIER
WITH REMOVABLE
DYNAMIC
SPEAKER
\$19.50
KIT
FACTORY WIRED—\$24.50
SET OF 5 TUBES... 5.75
HAND MICROPHONE 2.95

Novel design features include: Dual Voltage Doubling; Universal Input Coupling for 200-300-3,000 ohm Phono. Pickups, 100-200 ohm single or double button Microphones, and Radio Tuner; Tone Control; Gain Control; Power Transformer as Circuit. (No transformer to burn out!). Recommended for Window Demonstrations, Concessionaires, Call Systems, Stenographic Dictation, Department Store Counter Demonstrations, Sound Trucks, Bus Driver Announcements, Counter Men at Restaurants, etc. Furnished complete with leatherette covered carrying case, 13" x 10½" x 6". Total Weight 17 lbs.

Write for **FREE SEMI-ANNUAL CATALOG**
COAST-TO-COAST RADIO CORP
123 N. West 17th ST.
NEW YORK CITY

You Can Become a Fast, Capable
RADIO OPERATOR at Home

FREE—C. S. Code Guild Sked. Daily C. S. practice programs on amateur bands. **FREE** short wave press schedules. Learn to copy px from Candler trained ops, sending out of principal px stations. Amazing results in short time. **FREE ADVICE IF "STUCK"**. Write Candler. No obligation. Junior Course for beginners. Advanced Course for ops with speed of 10 wpm or over who want to get in 30 to 45 wpm class and copy behind. Also Radio Typing Course. Save time and money by sending for **FREE BOOK** today.
CANDLER SYSTEM CO., Dept. 1-D
6343 So. Kedzie Ave., Chicago, Ill.
World's Only Code Specialist





SUCCESSFUL MERCHANDISING

The only key we know to successful merchandising is, to help.

Helping the service man-dealer is the National Union policy which is bringing profit to many thousands of your fellow radio service workers. National Union help is given in many ways . . . by supplying tubes consistently superior in quality . . . by giving shop equipment, meters and manuals with the purchase of National Union tubes . . . by supplying up to the minute data sheets, such as Peak Frequency Charts, Voltage Divider Charts, Characteristic Charts, Tube Base Connection Finders and Tube Data Books . . . by constantly being alert to the needs of the service man-dealer as changes and advancements take place in the industry.

Can you as a progressive dealer afford to ignore the advantages of tying up with National Union tube line . . . let National Union help you . . . write or send coupon for full details of National Union equipment offers.

NOTE: Write for special bulletin on new National Union increased profit plan.

All offers subject to withdrawal without notice

National Union Radio Corp. of New York, 400 Madison Avenue, New York City.	
Send me information about all National Union free equipment offers.	
RN9	
Name.....
Street.....
City.....	State.....

**LEARN AT HOME TO BE
Good
Radio
Operator**



It's Easy

with
**The NEW
MASTER**

Teleplex

Code Teaching Machine

Pleasant, interesting work. No experience necessary. We guide you step by step—furnish you Complete Code Course and lend you The New Master Teleplex. Teleplex has instructed more students in the code in the past ten years, than all other systems combined. It is the only instrument ever produced that will record your own sending in visible dots and dashes, and then repeat it to you audibly on headphones. Used by U. S. Army and Navy, R. C. A., A. T. & T. Co. and others. Get started NOW. Low cost. easy terms. Write for folder RN-9 giving full details.

TELEPLEX COMPANY
76 Cortlandt St. New York, N. Y.

Free!

"23 Lessons In Radio"—a book on radio essentials including: Elementary Radio Theory; The Detector Tube; Construction of an A-F Amplifier, a S-W Converter, and a Low-Power Transmitter; Principles of Transmitting and Receiving; Standard Radio Symbols; Breaking Into The Amateur Game; and other important articles—given free with 5 issues of RADIO NEWS at \$1. (Canada & Foreign \$1.50)

Dept. 9 A

RADIO NEWS

222 W. 39th St. New York, N. Y.

Radio Echoes from Space

(Continued from page 137)

reflected once from the ground and twice from a conducting layer in the atmosphere. The other path goes through the point E, having one reflection only. Naturally, there is a difference in the length of these paths and the two incoming waves may interfere with each other, like light waves interfere with each other if they are reflected from a grating. So, by using directional antenna systems, the signal intensity in a certain direction is increased, and, in addition, fading can be greatly reduced. Short-wave transmitting stations of the type used for telephone communication between the United States and Europe or South America are of the double net type. For the transmission to Europe, for instance, the short-wave aerial of the American Telephone and Telegraph Company at Lawrenceville, New Jersey (near Trenton), consists of a double net supported on twenty-one towers in a row, laid out at right angles to a line extending from Lawrenceville to the short-wave receiving station near London. Similarly, the transmitting towers, which are one hundred and eighty feet high and two hundred and fifty feet apart, are set in right angles to the direction of Buenos Aires for communicating with this city. And for still shorter waves, plane-parabolic and circular-parabolic reflectors may be used.

By the use of directional antenna systems in both transmitter and receiver and the use of automatic volume control and diversity systems, the effect of fading can be almost eliminated. But this is a chapter in itself.

While only one continuous reflecting layer had originally been assumed, this hypothesis soon did not explain the various facts disclosed in systematic investigations. There is one phenomenon which, particularly, cannot be explained directly by the facts described above and which perhaps is the most interesting of them all. The Norwegian radio amateur, Jørgen Hals, has observed that echoes of short-wave signals could be noted, which were several seconds removed from the original signal. He told these observations to Professor Carl Stoermer. The latter, together with Dr. Balth van der Pol of the Natuurkundig Laboratorium der N. V. Philips, Holland, made a series of experiments and arranged special transmission with the Phillips short-wave transmitter PCJ for the study of these phenomena. Interesting echoes have also been observed by A. Hoyt Taylor and L. C. Young.⁴

It was found that several echoes were received at the same moment, in Norway by Dr. van der Pol, and independently by his assistant with a different receiver, in Eindhoven.

The time observed between the signals and the echoes was: 8, 11, 15, 8, 13, 3, 8, 8, 8, 12, 15, 13, 8, 8 seconds.⁵ Considering the fact that electromagnetic waves travel 186,284 miles per second, it seemed at the first impression that these waves must have traveled distances many times greater than the diameter or the circumference of the earth—distances which are in the dimension of the distance between the moon and the earth, and possibly even further than that.

The frequency of the echo was always exactly equal to the frequency of the signal. They could be readily identified. Combination tones received always had the same pitch (though of course of smaller intensity) regardless of whether the original signal was received or the echo.

As an explanation, Professor Stoermer tries to explain this phenomenon in that these waves are supposed to penetrate through the Kennelly-Heaviside layer, travel into space distances several times the distance between the earth and the moon.

Figure 5 shows a sketched interpretation of the original Stoermer hypothesis. These waves are supposed to be reflected by hypothetical clouds of electrons which travel in these regions. The electron clouds are believed to have been emitted from the sun.

Contrary to this explanation, Dr. van der Pol has published a different theory. He assumes that these waves, under certain conditions, have been considerably delayed. According to his theory, they travel over a certain distance *within the Heaviside layer!* This is in the conductive layer above the ground which varies between 60 and 150 miles in height above the ground. He has shown mathematically that at places where the ionization is critical, the velocity of the propagation becomes infinite, but at the same time *the group velocity moves toward the zero limit.*

Under certain conditions the waves may enter the layer and travel within this layer into regions where the group velocity is small. In regions where the dielectric constant falls to a low value, they again may be reflected toward the earth. Although such waves may *never* have traveled outside the earth atmosphere, a considerable time may elapse before the echo is received.

The present scientific world tends more and more toward the opinion that the theories similar to the one of Dr. van der Pol are the best interpretation of this phenomena.⁶

Figure 5 shows schematically what is believed to be the working hypothesis with the greatest approximation to the truth. The sky wave, according to this theory, does not bounce back immediately from one and only one reflecting layer, as was originally assumed. There may be a number of layers with different dielectric characteristics and an actual refraction and under certain circumstances even a considerable wave retardation may occur by reflecting radio signals in between the borders of these layers. One of these layers is called the Appleton layer. Naturally, as the earth is a sphere, and, accordingly, those layers have to be three-dimensional, echoes may be transmitted from various parts of the globe; hence the difference in time, intensity, polarization and other characteristics. The fact of the earth's magnetism enters here also. This also may explain the difference in the best wavelength for communication over distances which are at least partially irradiated by the sun and the different wavelengths most suitable for communication at night in their daily and yearly variations. For even shorter wavelengths in the ultra-short-wave region, as used for the transmission of television signals, still additional factors enter. While the longer ones of these waves are still, partly at least, reflected by the gaseous layers, the fact occurs, irritating for reception, that the field intensity at points a few feet apart from each other may be considerably different. For instance, in the center of a room there may be good reception while near a wall no signal can be received. The differences in these field intensities, however, is not due to any influences of the higher atmosphere, but is merely due to interference waves created by objects in the neighborhood of the transmitter and the receiver.

Perfectly free from reflection on the outer layers of the atmosphere are only the shortest centimeter waves of 20 centimeter wavelength and less. While at the longer waves of about 50 centimeters wavelength, as used in the experiments of Marconi, some reflection occurs, waves of the range of 20 centimeters or less pass through the Kennelly-Heaviside layer practically unabsorbed.

The frontispiece of this month's magazine

shows Marconi's reflector of his 50-centimeter waves as installed on the roof of the Vatican. Contrary to previous belief that these waves are not intercepted below the curvature of the earth, he has made occasional receptions at distances of about 80 miles and more. This, however, was no permanent and reliably reproduceable effect. His transmitter was pointed at clouds in the sky and the scattered radiation obtained from them was used for reception purposes, similar to the way a searchlight beyond the horizon can be seen far above its regular range, if it illuminates clouds far up in the sky.

In experiments at 15 centimeters wavelength and less, no transmitter signals were noted at considerable distances below the horizon. These "micro" waves, similar to light waves, are able to pass through the layers and are not reflected to any practical extent. Still, there seems to be an influence of the sun upon the transmission. If the sun was shining upon the reflectors, changes in the signal intensity and in the random noise occurred. Is it possible that the sun sends out not only light waves, but also such parts of the electromagnetic spectrum as are in the dimension of micro waves?

Note 1.—P. Lenard and C. Ramsauer, Ber. Heid. Akad. 1909-11.

Note 2.—G. Breit, and M. A. Tuve: A text of the existence of the conducting layer. Phys. Rev. 28, 1926, 554.
G. Breit, M. Tuve and O. Dahl: Effective height of the Kennelly-Heaviside layer. Proc. Inst. Rad. Eng. 16, 1928, 1236.

Note 3.—H. Mogel. Telefunken Zeitg, 11, Nr. 56 (1930), 14.

4 A. Hoyt Taylor and L. C. Young—Proc. Inst. Radio Eng., 16, 561; 1928.

5 Bath. der van der Pol—Nature, December 8, 1928.

6 P. O. Pedersen, Wireless echoes of long delay, Proc. Inst. Rad. Eng. 17, 1929, 1750.

Technical Review

(Continued from page 169)

of obsolete set analyzers such as the Jewell Pattern 198, 199, 408 and 409 analyzers, Weston Model 537, 547, 565 and 566 set testers, and Supreme 99-A, 400-A and 400-B diagnetometers into efficient, up-to-date testing equipment, at low cost. Servicemen and

experimenters, who have been working under the handicaps imposed by the use of analyzers which are no longer able to cope efficiently with the problems introduced by new tubes and receivers, will find this folder of great value. Special auxiliary units for increasing the usefulness of standard analyzers are also described.

44. *How to Add a Remote-Control and Station-Selector Unit to Any Receiver.* A descriptive folder published by Wholesale Radio Service which shows how any single tuning control receiver can be converted into a remote-control and station-selector set at a total cost of only \$12.50. The R.C.A.-Victor automatic remote-control unit used makes it possible to operate a set at a distance up to 75 feet from the tuner. Information is also given on how to add a remote-control unit to a P.A. tuner.

45. *Condenser Bulletin for 1933.* This bulletin gives complete descriptions, specifications and prices on the entire line of Potter paper and electrolytic condensers for by-pass, filter and replacement use in home and auto-radio sets. It also describes the interference filters and tone controls.

46. *Book of Facts on High-Speed Radio and Telegraph Code Sending and Receiving.* A 24-page book which explains the opportunities for pleasure and profit in radio and telegraph operating and the three inexpensive courses available through the Candler System for attaining high speed in sending, receiving and copying code on the "mill." Different courses are suited for different students such as beginners and experienced operators who wish to increase their speed. Please do not send for this material unless you are interested in learning how to operate or increase your speed.

47. *A Modern, Low-Cost Portable Public-Address System.* This bulletin describes and gives the specifications and price of an exceptionally efficient, low-cost portable public-address system—the type U-19—designed and manufactured by the United Sound Engineering Co. The unit employs the latest tubes and a 10-inch dynamic speaker, and is capable of amplifying normal speech and music for crowds up to 1000 people. With auxiliary equipment it can be used for crowds up to 3000 people.

48. *A Low-Cost Superheterodyne Receiver.* This folder describes the Goldentone midjet radio manufactured by the Fordson Radio Mfg. Corp. It is especially suited to fill the needs of the serviceman seeking a well-designed chassis for replacement purposes. The set contains many modern improvements and features not usually available in a set in its low-price class. The set is sold on a 30-day free-trial basis.

49. *Portable and Home Type Receivers.* This folder gives descriptions and prices of a line of receivers and chassis made by the Commonwealth Radio Mfg. Co. The list of receivers ranges from the most inexpensive midjet sets to the higher-cost console models. The line offers many profitable sales opportunities for dealers and servicemen.

51. *How to Build a 5-Tube Portable A.C.-D.C. Receiver at Low Cost.* Details of the "Pal" kit of parts designed by Wholesale Radio Service to meet the need for an efficient but low-cost universal portable receiver which can be built by servicemen and experimenters in their spare time and sold at a profit.

52. *The Servicer.* A monthly house organ published by the International Resistance Co. It contains information designed to help the serviceman do better work and make more money doing it.

Lafayette

A New KIT FOR HOME ASSEMBLY

SHORT WAVE MASTER "6"

For FOREIGN RECEPTION

that sets the pace for 1933!
The New Lafayette Master "6" Kit for home assembly will enable you to build a reliable S.W. Receiver which is highly sensitive—at a price which you can afford to pay! It features a cabinet with all partitions welded in place as a complete unit and the latest R.F. and A.F. pentodes in a T.R.F. regenerative circuit!
If you want foreign short wave reception that is worth hearing the Lafayette Master "6" Kit is the answer!

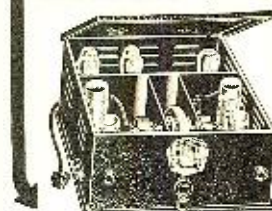

Short Wave Receiver Kit \$19.75
Coils per pair \$2.25
Power Pack Kit \$9.75

Big New FREE Catalog!

Be sure to have this Big, New 24 page Catalog of Public Address Short Wave and Transmitting Equipment! Every latest and important development in these fields is listed here at lowest wholesale prices. This is the most comprehensive catalog ever offered—and it's FREE for the asking! Scores of Burgains that you cannot afford to miss!



Wholesale Radio Service Co. Inc.
100 Sixth Avenue, New York, N.Y.

Dept. N-93

Please send me your new catalog of Public Address, Short Wave and Transmitting Equipment

NAME.....

ADDRESS.....

TOWN.....STATE.....

SERVICE MEN

● Prepare for the increased service work which will develop as a result of the RMA Rebuild Radio Prosperity Campaign, now in progress and to continue throughout the Summer and Fall.

RIDER'S MANUALS

Volumes I, II and III contain all of the service information you require to repair any radio receiver in your shop. These three manuals total more than 3000 pages of unduplicated material covering all radio receivers from 1919 right up to date . . .

RIDER'S MANUALS

are the most accurate—detailed and complete as proved by the fact that E. T. Cunningham, Inc., National Union Radio Corp., RCA Radiotron Co. use and sell them in tube deals and Weston Elect. Inst. Co., Hickok Elect. Inst. Co., Readrite Meter Works and others recommend them to their instrument owners.

JUST OUT
Volume III about 1185 pages.
List price \$7.50 postpaid. Sold with a Money Back Guarantee.

Rider's Perpetual Trouble Shooter's Manual, Volume III contains the only Chronological Catalog and index of every American radio receiver sold between January, 1921 and January, 1933.
You need Rider's Manuals for successful and profitable service work. . . . Get your copies today.
See them at all good radio dealers or buy them direct from us.

Send for descriptive literature!

Coupon

John F. Rider, R N9-33
1440 Broadway, New York City.

... Here is \$5.00 Send Rider's Manual Vol. I.
... Here is \$5.00 Send Rider's Manual Vol. II.
... Here is \$7.50 Send Rider's Manual Vol. III.
If I am not satisfied with my manual, you will refund my money.

Name.....

Address.....

City.....State.....

September, 1933

RADIO NEWS Free Technical Booklet Service
222 West 39th Street
New York, N. Y.

Gentlemen: Please send me, without charge, the booklets or folders I have filled in below:

Numbers.....

- Serviceman in Business for Myself
- Serviceman Employed by: Manufacturer, Jobber, Dealer, Service Organization
- Radio Engineer
- Experimenter
- Laboratory Technician
- Dealer
- Jobber
- Professional or Amateur Set Builder
- Licensed Amateur
- Station Operator

I am a subscriber newsstand reader.

I buy approximately \$..... of radio material a month.

Name.....

Address.....

City.....State.....

PLEASE USE PENCIL AND PRINT, IN FILLING IN COUPON

Remarkable Freedom
from NOISE... by use of

LYNCH

Short Wave Antenna System

Mark Isaacs Co.
210 SO. 728 CANAL STREET, N. O.

New Orleans

June 14, 1933

Mr. Arthur H. Lynch, Pres.
Lynch Mfg. Co., Inc.,
51 Vesey Street, New York, N. Y.

Dear Mr. Lynch:

Since my letter to you of June third I have spoken to several jobbers as well as servicemen with reference to your short wave antenna equipment. I have also demonstrated a Lynch Short Wave Antenna which I have constructed on the Philco Building, in one of the noisiest spots in our city. All who have seen this antenna and heard the marvelous results that have been obtained, are highly enthusiastic.

I am greatly interested in the advancement of Short Wave Receivers and Antenna equipment, and know from experience that the LYNCH Antenna System actually does, even in extreme cases, eliminate all disturbing noises.

You may be interested to know that I am installing Short Wave Sets and LYNCH Antenna Systems for such concerns as Maison Blanche Radio Department, Barnett Furniture Company, Marks Isaacs Company, Walther Bros., Inc., Godechaux Clothing Co., and D. H. Holmes Co., Ltd.

Yours very truly,
(Signed) GENE MORRIS.

Complete Kit \$5.00
At ALL LYNCH Jobbers and Dealers

If your Jobber, Dealer or Serviceman cannot supply you, order direct from us. Sent post-paid, with instruction booklet, for \$5.00.

Free Descriptive Folder Upon Request

LYNCH MANUFACTURING CO., Inc.
51 Vesey Street, New York, N. Y.

Makers of the Famous Metallized Resistors

FREE

—116-Page
Radio
and Short-Wave
Treatise



Avail yourself now of the opportunity of receiving our FREE—Radio and Short Wave Treatise, 116 solid pages of useful information, radio items, diagrams and illustrations. Positively the greatest book in print. **NOT JUST ANOTHER CATALOG.** Contains a large editorial section with valuable information not found anywhere else. **PARTIAL LIST OF CONTENTS:** Fundamental Principles of Radio; The Law of L—Discussion of New Tubes—Constructing a "Triple-Twin" Amplifier—All about Superheterodynes—Eliminating Man-Made Static—Constructing a Two-Tube Short-Wave "Globe-Trotter" Receiver—\$3.00 Prize Suggestions—Radio Kinks, etc.

100 New Radio
Hook-Ups
1000 Illustrations

WRITE TODAY. ENCLOSE 4 CENTS FOR POSTAGE. TREATISE SENT BY RETURN MAIL.

RADIO TRADING COMPANY
92 PARK PLACE NEW YORK

BUY THESE Great Books!

Radio Physics Course
by Alfred A. Ghirardi \$3.50

Radio Servicing Course
by Ghirardi & Freed \$1.50

Send for FREE circular at once
THE RADIO TECHNICAL PUB. CO.
45 Astor Place, Dept. RN-9, New York City

Radio Operating Radio Servicing

Prepare for the new Government Radio Operating license examinations; Radio Operator, Marine and Broadcasting. Also Radio Amateur Telegraph and Telephone. Residence courses. Write for booklet.

"Opportunities in Radio"

West Side YMCA Trade & Technical Schools
17 West 63rd Street New York City

The DX Corner

(Continued from page 165)

ceding month, especially on the 31-meter band, leaving this frequency the leader for results. The 16 and 19-meter bands have also been exceptionally fine. The 49-meter band has had considerable improvement, although static has been considerable and the signals of foreign stations have not been as good as in the early Spring. During the coming month we look for still further improvement in the three lower bands.

VE9GW Transmission

An official communication from the Trans-Canada Broadcasting Company shows the present schedule for the Canadian "goodwill" station VE9GW. Monday and Tuesday, 8 a.m. to 12 noon; Wednesday, silent; Thursday and Friday, 4 to 8 p.m.; Saturday, 4 p.m. to 12 midnight; Sunday, 11 a.m. to 9 p.m.

VE9HX Transmission

An official communication from the Maritime Broadcasting Company, Ltd., gives the following program data for station VE9HX. This station has a frequency of 6110 kilocycles. It is located at Halifax, N. S., and the hours of transmission are from 9:30 a.m. to 12:30 p.m., Atlantic Standard Time, daily, and from 6 to 11 p.m., A.S.T. The station uses a 4-gong signal before station announcement, every half hour.

VE9JR Transmission

An official communication has been received from the short-wave station VE9JR as relayed by Mr. A. G. Taggart, for station VE9JR at Winnipeg. This schedule shows this station will be on the air daily except Saturdays and Sundays, from 8:30 to 9 a.m., 10 to 10:35 a.m., 1 to 1:15 p.m., 2:15 to 2:35 p.m., 6 to 9 p.m. (except silent from 7:45 to 8 p.m. Tuesday, silent 7:30 to 7:45 p.m. Wednesday, and silent 5:30 to 8 p.m. Thursday and Friday).

It will be on the air Saturdays from 8:30 to 9 a.m., 10 to 10:30 a.m., 11:45 to 12:15 p.m., 6 to 7:30 p.m. and from 10 to 11 p.m.

On Sundays it is on the air from 8 to 9 p.m. All time given is Central Standard Time.

Transmissions from the Russian Short-Wave Station

An official communication from Moscow Trade Union Station RV59 shows that they will be on the air on 6000 kilocycles from 3 to 4:30 p.m., E.S.T., daily.

XETE Transmissions

An official communication from the Ericsson Telephone Co., Mexico City, shows that the new short-wave station XETE will be on the air on 9600 kilocycles or 31.25 meters, daily, from 2:30 to 4:30 p.m. and from 6 p.m. to midnight.

The Dutch Station PHI Transmission

An official communication from N. V. Philips Omroep shows that the short-wave station PHI will be on the air on Mondays from 8 to 10 a.m., E.S.T., on Tuesday and Friday also from 8 to 10 a.m., on Saturday and Sunday from 8 to 10:30 a.m. Announcements are made in six languages and the station frequency is 1778 kilocycles or 16.88 meters. The transmitter is crystal-controlled and has a power of 130 kilowatts.

Best Reception from Cuba

Mr. Leonard Lindo of Central Tanamo, Cayo Mambi, Oriente, Cuba, reports that he hears best the following stations on short

waves: FYA, W8XX, GSD, W1XAL, I2RO, DJD, GSB, 2XAF, W1XAZ, GSA and DJC. Mr. Lindo neglected to mention the kind of receiver he is using.

Reception Reports from Indiana

Mr. J. W. Hopkins sends in a report of the following stations as best heard at Whiting, Ind. The list follows: XETE, FYA, I2RO, DJD, VE9JR, YVQ, TI4NRH, EAQ, CT1AA, DJA, OXY, GSB, VK2ME, VK3ME, RV59, GSA, DJC, YV1BC, VE9GW, RV15, HJ1ABB, HJ2ABA, HJ4ABE, HC1DR, CN8MC, HBP, VE9DR. Mr. Hopkins uses a Scott all-wave receiver.

Another Report from North Carolina

Mr. H. O. Murdock, Jr., owner and operator of stations W4ZB, W4ZZF and W4AOK, reports the following stations as best received at Charlotte, N. C.: HRB, FYA, DJC, DJA, I2RO, EAQ, VE9GW, VE9JR, W9XAA, W9XF, W8XX, W3XAU, W2XAD, W2XAF, W1XAL, W1XAZ. Mr. Murdock uses a Stewart-Warner converter with a Philco receiver. He mentions a station never announcing in English and playing, sometimes, for 15 minutes at a time about six chords on a piano, over and over. (This station is DJD.)

On a Home-Built 3-Tube Short-Wave Set

Mr. L. Marseilles, Mystic, Conn., listens to the following stations regularly on his little set: W8XX, VE9GW, GSA and EAQ. He receives many other stations. These, however, are the best and most consistent.

Best Bets for Illinois

(Mrs.) L. R. Ledbetter of Bloomington, Ill., writes to us on the letter-head of the International DX'ers Alliance, that the "best bets" in her location are FYA, GSF, DJB, I2RO, DJD, EAQ, TI4NRH, CT1AA, DJA, GSB, DJC. Mrs. Ledbetter mentions that she is just in receipt of her eighth verification of reception from the Antipodes, one of them from 4JO, using only 100 watts at the time of reception. She neglected to mention what type of receiver she is using.

Best Reception at Lyons Falls, N. Y.

Mr. K. F. Hurst reports the following stations as received best: PHI, CEC, HJY, W8XX, DJD, I2RO, W2XAF, GSD, GSE, VE9JR, VE9DR, VE9GW, DJC, W9XAA, W9XF, W3XAL, W8XAL, W2XE. He did not mention the type of receiver he uses.

Mr. Arthur Conklin, Norwich, N. Y., reports following best reception, with a Scott all-wave de luxe receiver: EAQ, DJA, DJD, DJB, DJC, FYA, I2RO, W2XE, W8XX, GSE, GSC, GSA, GSD, GSB, YV1BC. He mentions that DJC announces, in English, the schedule and location of station with the program for the next day. Every evening, between 8:55 and 9 p.m., E.S.T., this station signs off with the German national anthem and a military selection. He mentions that DJD and DJA can be recognized, during the afternoon, because they stop their programs and play a few chords on a piano over and over. YV1BC announces "Broadcasting Caracas" and plays steel chimes every 15 minutes.

Best Reception at Erie, Pa.

Mr. F. L. Stitzinger, Erie, Pa., gives us the following list of stations best received at his location on two receivers, the Scott All-Wave and the Scott De Luxe, using a tuned antenna 200 feet long. He is a member of the

Heard All Continents Club. The list follows: PLE, PLV, GSG, GSF, GSE, GSD, GSC, GSB, GSA, GAU, GAS, GAW, GBC, GBW, GBB, GBC, GBU, GBS, GCU, GCW, GCA, GCB, HPI, DJB, DJD, DJA, DIQ, DGO, DAN, DJC, DFB, HVJ, I2RO, IAC, EAQ, TI4NRH, RABAT, VE9HX, VE9GW, VE9DR, W3XAL, W8XK, W2XAD, W2XAF, W1XAL, W2XE, W3XAU, W1XAZ, W3XL, W9XF, W9XAA, W8XAL, W4XB, WNC, WKJ, WEL, WLA, KWU, KKW, KKP, KDK, CT3AQ, LSN, LSM, LSX, J1AA, CT1AA, VK2ME, VK3ME, HBL, HBJ, HBP, HBQ, OXY, PRBA, PSH, PSK, PPO, HC2JSB, PRADO, HC1DR, HCJB, HJ3ABF, HJ3ABD, HJABB, HKN, HKE, HKS, HKA, HJ1ABB, HJ4ABE, HJ2ABA, HJB, HJY, CM5RY, CMCL, XDA, XAM, XTER, TGX, TGW, YV11BMO, YV3BC, YB1BC, YVQ, RW59, RXC, WTDV, OC1, CEC, TAR, ORK, OPM, VRT, SUZ, F31CD.

Good Results from Roanoke, Va.

Mr. D. W. Parsons mentions that he hears best the following stations: FYA, DJB, DJD, CT1AA, HBP, HBL, GSA, GSB, GSD, GSE, I2RO, EAQ, VK2ME, VK3ME and the usual list of South American stations. He mentions, as stations coming in fairly well but not often, OXY, PHI, LSX, TI4NRH, J1AA, HVJ, RABAT, RV59, XETE.

Results in Nevada

Mr. J. F. Schmieskors, Boulder City, mentions that, using the National ACSW58 with a doublet antenna and transposed lead-in, he has received best results from the following stations: XETE, W3XAL, W8XK, I2RO, VE9JR, EAQ, TI4NRH, VK2ME, W1XAZ, W2XAD, W8XK, RV59.

Some Dope from Alabama

Mr. J. E. Brooks, Montgomery, Alabama, reports that he logs consistently station DJB on 19.73 meters from 8 a.m. to 12 noon, DJA on 31.38 meters from 12:30 to 6:30 p.m., DJD on 25.51 meters from 10 a.m. to 4 p.m. and DJC on 49.83 meters from 5 p.m. to 9 p.m. E.S.T. This would put DJB and DJD on at the same time, while DJA and DJC are paired up likewise. The best reception in Alabama comes from DJB, DJD and DJC.

Report from Brunswick, Maine

Mr. C. Winslow Lewis, Jr., of Brunswick, Maine, sends the following list of best-received stations in his locality with a Philco Model 4 converter ahead of an Atwater Kent 246 receiver: PHI, DJA, DJB, I2RO, FYA, EAQ, LSX, VE9GW, VE9JR, VE9DR, W2XE, W2XAF, W3XAL, W3XAU, W8XK, W8XAL, W9XF, W9XAA.

Broadcast Reception from Washington, D. C.

Mr. J. T. Baber of Washington, D. C., reports that, using a Stewart-Warner 6-tube superheterodyne with built-in short-wave converter, he has pulled in the following short-wave stations most consistently: GSA, GSB, EAQ, DJC, FYA, I2RO. He listens in only in the late afternoon and early evening. He uses a shielded lead-in to the point where the wire enters the window, which is on the second story of a 7-story apartment house.

British Station's Tuning Note

Mr. W. H. Fraser, Bracebridge, Ontario, gives the following information: "Of possible interest for DX Corner readers is the verification letter I received from the British Broadcasting Company. It mentioned that the musical note preceding the Empire transmission is a tuning note of 1000 cycles, to enable listeners to tune in their receiving sets for the broadcast. It is 'on' every 15 minutes before each transmission."

A Report from Cincinnati, Ohio

Mr. Luther Stewart of Cincinnati, Ohio, reports the following stations as coming in the best in his location: EAQ, GSC, VE9GW, HBP, YV1BC (very loud but sometimes mushy), DJA, XETE, as well as all of the American and Canadian stations.

Best Reception in California

Mr. Robert J. Schulz of Wilmar, Calif., reports the following stations as most consistent: VK3ME, VK2ME, EAQ, VE9GW, VE9JR, W9XF, W2XE, W3XAL, W1XAZ, W1XAL, XETE. Mr. Schulz uses a 5-tube, tune r.f. receiver which is a.c. operated and uses type -58, type -56, type -47 and type -80 tubes. His antenna is a tuned doublet with a transposed lead-in. He also mentions that, according to a statement received from VK2ME, they are broadcasting simultaneously on 31.28 meters and on 7 meters.

Report from Puerto Rico

Mr. Luis Garcia, Puerta de Tierra, remarks that with a Pilot Super Wasp he hears daily with "fine voice" the following stations. W3XAL, PHI, EAQ, TI4NRH, W2XAF, PRADO, YV1BC, XETE, YV3BC. He reports that next month at San Juan, Puerto Rico, there will be another station on 1290 kilocycles with call letters WNEL.

Readers Who Helped Log Stations for This Month's Report

We are indebted to the following readers of RADIO NEWS who sent in logs of reception this month: W. Plunkett, Stilesville, Ind.; J. G. Abrahams, London, England; H. L. Tear, Pittsburgh, Pa.; W. H. Foth, Clifton, N. J.; Geo. Lilley, West Chester, Pa.; D. Wood, Nixon, Ont., Can.; J. E. Brooks, Montgomery, Ala.; G. A. Hambke, Woodbury, N. J.; A. L. Hutchins, Macon, Ga.; J. F. Luttman, Milltown, N. J.; J. C. Reynolds, Calais, Me.; O. W. Parsons, Roanoke, Va.; F. L. Stitzinger, Erie, Pa.; S. H. Lawrence, Anamosa, Ia.; C. E. Stanford, Oneida, N. Y.; J. Horvath, Cleveland, O.; L. Garcia, Puerta de Tierra, P. R.; C. Fiene, Steelville, Ill.; A. Graham, Edinburgh, Scotland; C. H. Long, Winston, Mo.; Robt. J. Schulz, Wilmar, Cal.; A. B. Coover, Union City, Ind.; Luther Stewart, Cincinnati, Ohio; J. Thompson, Bethlehem, Pa.; W. H. Fraser, Bracebridge, Ont., Can.; A. S. Yeouze, Buffalo, N. Y.; C. O. Blandin, Omaha, Neb.; B. Dickter, Bronx, N. Y. C.; G. M. Degreee, Schenectady, N. Y.; W. A. Minchin, Queensland, Australia; J. T. Baber, Washington, D. C.; Y. E. Taylor, Pauls Valley, Okla.; A. G. Taggart, Reedy Creek, Man., Can.; W. S. Tindall, Macon, Ga.; C. Winslow Lewis, Jr., Brunswick, Me.; E. H. Lord, Cheshire, Conn.; W. Schellenberg, Guatemala, C. A.; J. Leininger, Reading, Pa.; Arthur Conklin, Norwich, N. Y.; K. F. Hurst, Lyons Falls, N. Y.; P. Caggiano, New York, N. Y.; Mrs. L. R. Ledbetter, Bloomington, Ill.; Louis Marseilles, Mystic, Conn.; D. Lee, Jr., Philadelphia, Pa.; H. O. Murdock, Jr., Charlotte, N. C.; J. W. Hopkins, Whiting, Ind.; L. Lindo, Oriente, Cuba; E. H. Barrow, Anasco, Puerto Rico.

Shielded Lead-in

(Continued from page 149)

not introduce the interference into the receiver, even though the lead-in may run in rather close proximity to the trouble-making power wires, the overall effect will be a considerable reduction of noise.

In general, wherever there is present noise interference other than atmospheric static, an antenna system such as the one discussed here will be well worth trying.

PORTABLE PUBLIC ADDRESS EQUIPMENTS

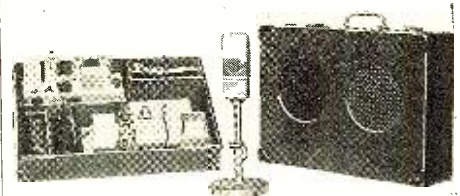

TYPE PG-62—A complete Portable Public Address System, including the famous *Velocity* Microphone, a high grade Class B 20 watt amplifier, and two modern dynamic loudspeakers,—all self-contained in one convenient carrying case. Operates on 110 volt AC and is designed to faithfully reinforce speech and music. Has provision for electric phonograph input.

Price complete, **\$350.** Amplifier units only, **\$112.50**

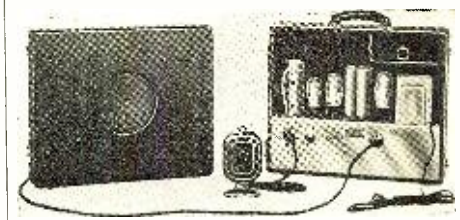

TYPE PG-63—A smaller and lighter design including close talking carbon microphone, Class B 6 watt amplifier and dynamic loudspeakers,—all self-contained in one convenient carrying case. Operates on 110 volt AC and is designed to reinforce speech and music, and has provision for electric phonograph input.

Price complete, **\$67.50.** Amplifier only, **\$45.00**

Write for descriptive folders.

Photophone Division

RCA VICTOR COMPANY, INC.

Camden, N. J.

"RADIO HEADQUARTERS"



AMERICA'S OUTSTANDING MICROPHONE VALUE

Lifetime Model No. 88 is the most remarkable value in a microphone ever offered! It is ruggedly constructed—precisely machined—beautifully chrome plated—1 1/2" diameter—1 1/2" thick overall—and weighs 1 1/2 pounds! It has a duralumin diaphragm (500) nickel-gold mesh screen—1/8" mesh—ring arrangement—gold contact buttons of 200 ohms each—nickel-plated dump and possesses a practical 4" face voice response (with the correct voice and musical range).

Especially GUARANTEED to more than please you!

A \$35.00 VALUE

Double Button Microphone

For Only \$6.95

Send postpaid on receipt of remittance—or C.O.D. plus charge

- Chrome Plated Desk Stand—8 in. High—Complete with Springs **\$1.95**
 - Stately Bronze Banquet Stand—15 in. High—Complete with Springs **\$2.95**
 - Stately Bronze Floor Stand—Adjustable 4 to 7 Feet—Complete with Springs **\$4.95**
 - Transformer to Match Model 88 Mike—Unshielded **89c**—Shielded **\$1.45**
- Your Call Letters—Name—on any five letter word can be placed on the DESK STAND ONLY for 28¢ additional
- Write for descriptive literature of our Electro-Dynamic Speaker Units—Aluminum Tri-speaks, etc., offered at lowest prices in America.

SPECIAL OFFER

Model No. 6 Double Button Microphone—for amateurs—public addresses, etc. A \$10.00 Mike for only **\$1.95**

Model No. 6 is a bright aluminum finish, precisely machined Mike—3/8" in. diameter—1 in. thick—weighs 8 oz. Has gold plated diaphragm of special construction—gold plated buttons—200 ohms each—frequency 40 to 3500 cycles within 4 Db.

Stand with call letters to match **\$1.50**

The LIFETIME CORP. 1306 DORR ST. TOLEDO, OHIO

FREE RADIO CATALOG

1934 RADIO CATALOG

Write for our new catalog now in the press—most complete line of latest radio sets, service men's supplies, replacement parts at lowest wholesale prices.

ALLIED RADIO CORP.

831 W. Jackson Blvd. Chicago

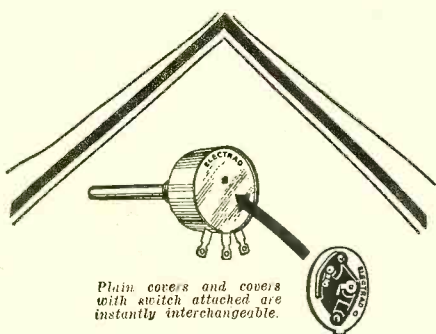

Plain covers and covers with switch attached are instantly interchangeable.

Ever See Volume Controls Like This?

Power-switch assembly and standard end covers are interchangeable, without disturbing control connections. Long ALUMINUM shafts—easily cut to desired lengths. Only five types required to service 799 standard receiver models.

Also RESISTORS and POWER-AMPLIFIERS

For Every Purpose

Write Dept. RN-9

For Catalog

175 Varick St., New York, N.Y.

ELECTRAD

THE "PRIZE WINNER"

As Described in August Issue
AC-DC Short Wave Receiver

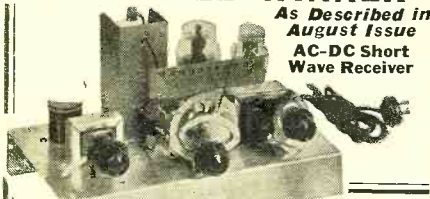

Completely Self-Powered Latest Type
77.43 an 2525 tubes—15 to 200Waters
The prize winner complete 30,000 to 1500 KC. Complete kit of prize winner parts identical with those used in built-up models including hardware, hookup w. e. solder, coils, etc., also \$8.95 cabinet and dial. Price..... \$3.75
Kit of RCA or Arcturus tube..... \$3.75
Assembled, wired, tested and enclosed in beautiful crackle finish or Cadmium Plated metal cabinet, hinges cover, ready to plug into your power line, complete with four coils..... \$10.95
Send for full particulars and Diagram
ALAN RADIO CORP., 83 S. Cortlandt St., New York City

This E & H Set-Tested

AERIAL ELIMINATOR

Fits inside radio cabinet. Size 1 1/2 x 4 inches—equals average 75-ft. aerial, 50 ft. high. Installed by anyone in a moment. No light socket connection or current used. Eliminates poles, wires, lightning hazards. More sensitivity and volume on all stations. Each tested on 1127-mile reception. Used in U. S. Hospitals. Order now for greater radio satisfaction. Shipped post-paid under three-day trial on money-back guarantee. Send \$1.00 bill, check or M-O, or sent C. O. D. if preferred. Send this ad as your order together with name and address. For dealer's proposition check here ().
F & H Radio Laboratories, Dept. 21, Fargo, N.D.

Complete POSTPAID

ANALYZER

Assemble your own WESTON METERED UNIVERSAL TESTER. Complete set of parts ready to wire including aluminum case, posts, panel, etc., with full instructions at extraordinary low net price of \$29.45. Companion Analyzer and Oscillator units also ready to complete your servicing kit. For details on above Analyzer see page 126, August Radio News. Also write for full information.
UNIVERSAL METER WORKS
414 North Leavitt St. Chicago, Ill.

P. B. Photocell

(Continued from page 144)

contact-holder members and also the terminals to which the leads from the electromagnet are soldered. These terminals, all of them, are held to the bakelite panel by means of small rivets. A fifth terminal is formed by a connection with the frame proper—that is, the lower right-hand terminal is riveted to the frame, which really amounts to a ground.

The detail of the adjusting screw at the back of the relay is so simple that a description of it is not necessary.

If the diagram of connections for this relay are traced through after its construction, the builder will find that the relay may be made to function to keep a circuit closed either while the light is playing on the cell or when the cell is in darkness. It may be so used that when the photo-cell is in darkness, the relay will be closed. An impulse from the cell will then cause the relay to open. This is done by the use of the upper contact with which the armature remains in contact normally. If this contact is not used, but the lower is used instead, the relay will close a circuit only when an impulse is received from the cell. The experimenter will find uses for the cell in which this feature of the relay will prove invaluable.

A small, sensitive relay of this type cannot be used to control very heavy currents, and for this reason it will be necessary to build a secondary relay so constructed that it will be closed by the first or sensitive relay.

The drawing for this second heavy current relay is shown in Figure 2. Here it will be seen that the core of the electromagnet is formed by an iron machine screw and that a complete magnetic circuit is created by the armature (which is also of soft iron) and the member holding the magnet. The armature is provided with a contact in the same manner as the armature for the sensitive relay—that is, so that it will operate in either direction. The two other contacts are carried by the bakelite member which is forced on the core. These contact points may be formed with bits of silver.

The armature for this second relay is simply provided with two projections or feet that fit into two indentations cut in the part of the frame carrying the magnet. A hole in the armature permits an iron piece to project through (this being held to the main portion of the frame by means of rivets) and this member carries a tiny spring which is so adjusted that it normally holds the armature against the outer contact point which also acts as a stop.

The writer has not, up to this point, mentioned the amount or size of the magnet wire used in this heavy-current relay or circuit-breaker. This will depend upon the exciting current that is to be used. If the experimenter wishes to use a single dry cell to excite the relay, he should wind the magnet with number 18 enameled wire. If high voltages are to be used, the size of the wire may be reduced and a larger number of turns used.

The experimenter will also note that this second relay was really designed to operate with the first one. That is, it has a double contact system and may function either "forward" or "backward." However, when this system is used, it is necessary to adjust each relay so that it will respond. When the first relay is adjusted so that it functions when the light strikes the cell by opening a circuit, the necessary changes in connections must also be made on the second or heavy-current relay.

Details of the construction and use of a simple photoelectric cell will be found in the October, 1932, and January, 1933, issues of RADIO NEWS.

Portable P. A. System

(Continued from page 156)

and B battery blocks, it will provide an output power in excess of 3 watts. For this arrangement the type -41 tubes are employed in the power stage.

Construction

In reference to the assembly and wiring of this P.A. system, the constructor can refer to the illustrations and the circuit diagrams in Figure 1. There is nothing difficult in its construction, and the other illustrations will show the proper placement of most of the parts.

Operation

Operating the system on 110-volt d.c. or a.c. current is extremely simple. For battery operation the battery cable is employed and, by means of the jumpers in the cable adapter plug, the tubes are connected in parallel so that they can be operated from 6 volts.

The condenser C2 is connected between the ground binding post and the amplifier chassis, so as to prevent any possible danger of a short-circuit. For 110-volt d.c. operation the line plug must be connected for correct polarity! If at first there is no signal, reverse the line plug and the P.A. system should immediately provide results.

With a few changes, this sound-reproducing system can be made to operate from 32-volt or 220-volt a.c. or d.c. lighting lines.

Parts List

- Individual items are herewith shown, although the complete P.A. system can be had either in kit form or completely wired, ready for use, including dynamic speaker, microphone, battery, etc., from the Coast to Coast Radio Corp.
- BP1, BP2—Input binding posts
- C1—.02 mfd., 300-volt tubular condenser
- C2—.5 mfd., 200-volt tubular condenser
- C3—.5 mfd., 35-volt electrolytic condenser
- C4—.002 mfd., 300-volt mica condenser
- C5—.4 mfd., 175-volt electrolytic condenser
- C6—.8 mfd., 250-volt electrolytic condenser
- C7, C8—Dual 12 mfd. each, 175-volt electrolytic condensers
- R1, R3—500,000-ohm potentiometer
- R2—2700-ohm, 1-watt resistor
- R4—50,000-ohm, 1-watt resistor
- R5—5000-ohm, 1-watt resistor
- R6—200-ohm, 2-watt resistor
- R7—30-ohm, 3-watt wire-wound resistor
- SW1, SW3—s.p.s.t. toggle switch
- SW2—d.p.d.t. toggle switch
- T1—Universal input transformer
- T2—Input push-pull transformer
- T3—Output transformer
- 4 6-prong sockets (small type)
- 1 5-prong socket (small type)
- 1 stamped and drilled metal chassis
- 1 leatherette-covered carrying case
- 1 dynamic type speaker (field winding 1000 ohms)
- 1 double-button hand microphone
- 1 4 1/2-volt C battery
- Miscellaneous hardware and wire

Short Waves

(Continued from page 143)

schedules often in order to reach certain places they wish to be heard. To wait till you happen to run into them, telling about the changes, would be wasting time. A powerful station may be heard one month and then the next month not be heard at all, simply because they have started operating on a new schedule. The only way in which such information can be gathered in time to be of any help is from a group of listeners, for where one may hear an an-

nouncement, hundreds of others may miss it because they are not tuned in at the same time. Nearly four years ago a group of short-wave listeners found this out and organized a club to exchange information and ideas. Today this organization has members in nearly every country of the world and maintains a monthly publication of the information gathered by the members. This organization is the International Short-Wave Club, with headquarters at Klondyke, Ohio, U. S. A.

For listeners who desire to "fish" for stations, the following set of rules is given. Due to the effect of light on short waves, certain wavelengths will not carry to any great distance at certain times of the day or night. From 14 to 20 meters tuning should be done from daybreak till about 5 p.m., local time. From 20 to 33-meter stations to the east of the listener come in best between 11 a.m. and 10 p.m. And on the same wavelengths stations to the west of the listener come in best from about 1 a.m. till about two hours after daybreak. From 33 to 75 meters, distant stations can be heard only when there is a great amount of darkness between the listener and the station, and this means tuning should be done at night.

After all, it does not require an expert to get results on short waves and it is not a trick of magic to tune in many distant stations. All that is required is a good receiver, some common sense and up-to-date information on short-wave stations, schedules and wavelengths.

New Metal Tubes

(Continued from page 139)

tested and found to be in perfect working order after having traveled through the mail 1200 miles, entirely without a carton or packing, the address being on a label tied around the metal shield

Storage space on the dealers' shelves for these new tubes is reduced to about one-sixth of that required for existing tubes having large glass bulbs and requiring a strong package to prevent breakage. The small size of these new tubes also makes them particularly suitable for use in the smaller sets such as midgets and portables. And the makers claim much greater uniformity between the tubes, due to the new construction.

And so it can be seen that in these new tubes tradition has been thrown to the winds and the development might have been made by someone who knew the principles of tube operation but had never seen or had one described to him. It looks like an entirely new application, for precedence has not been considered and every part has been manufactured with a view only to the functions that they have to fulfill.

Linear Detection

(Continued from page 145)

$$\frac{KA}{\pi} + \frac{MAK}{\pi} \cos \varphi + \frac{KA}{2} \cos \theta + \frac{MAK}{4} \cos(\theta + \varphi) + \frac{MAK}{4} \cos(\theta - \varphi) + \frac{2KA}{3\pi} \cos(2\theta - \varphi) + \frac{MAK}{2\pi}$$

It will be noticed that this d.c. term $\left(\frac{KA}{\pi}\right)$ is proportional to the carrier amplitude (A) and is independent of the percentage modulation. This is a very important

consideration in radio receivers which employ linear rectifiers for automatic volume control, since if the percentage modulation affected the value of the d.c. component, non-linear distortion would occur on deeply modulated carriers. Moreover, no harmonics of the modulation or signal frequency occur. This is also of great importance in that it indicates distortionless detection. All other components are high frequencies which are readily eliminated by the usual filter circuits.

This device can, of course, be used for any type of characteristic for which a series is available. It will be found a great time saver in most instances and does not involve any loss in accuracy over the standard Fourier method of solution.

Math. in Radio

(Continued from page 152)

$$(a) \int_a^b y \, dx = \int_a^b I \max \sin \theta$$

We see from the figure that $a = c$ and $b = \pi$. Thus (a) becomes

$$(b) \int_0^\pi I \max \sin \theta$$

Integrating:

$$(c) \int_0^\pi I \max \sin \theta = I \max \int_0^\pi [-\cos \theta]_0^\pi$$

Substituting, and remembering that $\cos \pi = \cos 180^\circ = -1$ and that $\cos 0 = 1$, we have:

$$(d) I \max [1 + 1] = 2 I \max$$

Now, in order to determine the average ordinate of the shaded portion, it is only necessary to divide the value obtained in (c) by the base (π) thus:

$$\frac{2 I \max}{\pi} = .636 I \max$$

Therefore:

$$I \text{ avg.} = .636 I \max$$

Backstage

(Continued from page 163)

in America and a similar period in England. Lou Welch has already played the Perlmutter rôle on the stage.

THE Three Roberts Brothers—Dan, Marty and Louis—have been winning much comment from listeners for their unusual musical programs over NBC. The three lads use a novel ensemble of violin, guitar and bass viol, and they use their voices to mimic the sounds of other instruments. In effect, the trio can in some ways be compared with the Mills Brothers. The Roberts Brothers hail from Philadelphia and they have not been professional entertainers very long. They are nephews of Molly Picon, noted comédienne of the Jewish stage. They were playing in a Broadway night club when the attention of NBC officials was called to the trio's unusual style, and before much time elapsed the boys were booked as regular network performers.

LOU HOLTZ, stage comedian, Grace Moore operatic and concert star, and Leonard Hayton's Orchestra are co-featured on the new Chesterfield series presented over CBS Friday nights. Norman Brokenshire, veteran announcer who was identified with the previous Chesterfield series, has been retained for the Friday broadcasts. Holtz, a familiar figure to network audiences, established a name for himself as a musical comedy and revue star. He varies his dialect story-telling activities on the Chesterfield programs with

Silver-Marshall Manufacturing Co. Presents



Round-the-World receiver
LABORATORY BUILT

—the startling new
Hallicrafters'
All-Wave SUPERHETERODYNE

Guaranteed Selectivity

New Clough Quadri-Tuned Intermediate Amplifier provides selectivity guaranteed to be greater than that of any other set, yet eliminates distortion from sideband cutting.

Automatic Tone Control

Another great first! Noise-free short-wave reception. Interstation noise on both local and distance reception and annoyance from static eliminated.

World-Wide Reception

England, France, Italy, Australia, Germany and many others tuned consistently because of new super power tubes used in circuits of high efficiency developing tremendous amplification.

Color Band and Frequency Index Tuning Dial

Tedious hunting for short-wave stations is done away with. New colored frequency-band dial with shadowgraph band indicator and each band divided into channels marked with the class of stations occupying them, is used.

Write for complete information about this new super-power receiver. It is totally unlike any set ever before designed. Learn what Hallicrafters' will mean to the future of radio!

FREE — this new book
Hallicrafters'



The Silver Marshall Manufacturing Co.
417 N. State St., Chicago, U. S. A.

Silver Marshall Manufacturing Co.
417 N. State St., Chicago, U. S. A.

You may send me FREE your new book telling the remarkable story of HALLICRAFTERS'.

Name _____
Address _____

LEARN IN LOS ANGELES
Radio-Television
ELECTRICITY—TALKING PICTURES
BROADCASTING—Special Limited Offer!
4 FULL COURSES AT PRICE OF ONE COURSE. R. R. coach fare allowed to L. A. Earn income while learning. 25,000 graduates. Latest facilities. No dummy equipment. Free employment service. Est. 28 yrs. Send for FREE illustrated Catalog. Tells how to earn big pay.
NATIONAL RADIO & ELECTRICAL SCHOOL
Dept. RN-9 4006 S. Figueroa Los Angeles, Calif.

SERVICEMEN!

THE MOST COMPLETE LIST OF CONDENSERS AND RESISTORS FOR EVERY RADIO USE
Write for our new 8-page Catalog folder free of charge





McMURDO-SILVER

DO YOU WANT
THE ACTUAL FACTS
ON ALL CUSTOM BUILT
RECEIVERS?

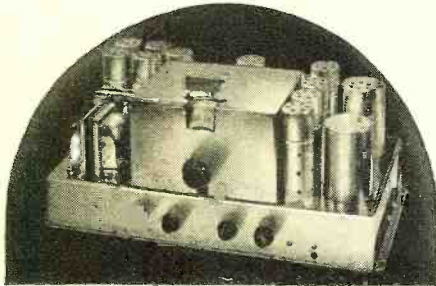

There has been so much controversy concerning the comparative merits of the leading custom-built receivers, that I have decided to place the true facts before you. The Masterpiece and the others have been measured by an independent testing laboratory. The findings have been authenticated by unbiased authorities. This information . . . these incontrovertible FACTS . . . together with the complete story of The Masterpiece will be sent you upon receipt of 6¢ in stamps. Please use the coupon.

McMurdo Silver, Inc.

1130 W. Austin Ave. Chicago

McMurdo Silver, Inc.
1130 W. Austin Ave., Chicago
6¢ in stamps enclosed. Send me engineering comparison of leading custom-built receivers and 16-page book on The Masterpiece.

Name.....
Street.....
Town.....State.....

Read Classified Advertising—It Pays

Advertisements in this section twenty-three cents a word for each insertion. Name and address must be included at the above rate. Cash should accompany all classified advertisements unless placed by an accredited advertising agency. No advertisements for less than 10 words accepted. Objectionable or misleading advertisements not accepted. Advertisements for these columns should reach us not later than 1st of 2nd month preceding issue. TECK PUBLICATIONS, INC. 222 West 39th St. New York, N. Y.

Correspondence Courses

USED Correspondence Courses and Educational Books sold or rented. Inexpensive. Money-back agreement. Catalog listing 3000 bargains—FREE. (Courses by Lee Mountain, Pisgah, Alabama.)

short, fast-moving comedy sketches. Grace Moore has had considerable radio experience in addition to her opera, concert, musical comedy and talking-picture achievements. Hayton's Orchestra was heard on the previous Chesterfield programs.

THE Friday night Pond's Hour heard over the NBC was recently converted into a variety program featuring well-known radio and stage personalities. Victor Young's Orchestra succeeded Leo Reisman's unit on the program and Paul Small and Lee Wiley are the featured vocalists on the new series. Hugh O'Connell and Ilka Chase, both recruited from the stage, present comedy bits. Victor Young has earned a following as a composer as well as a conductor. Lee Wiley was retained from the former Ponds series at Young's request. Paul Small has been featured on the air as tenor soloist for several prominent orchestras. Hugh O'Connell's best-known stage rôle was in "Once in a Lifetime." Ilka Chase was seen on Broadway recently in the Tallulah Bankhead play, "Forsaking All Others."

The Service Bench

(Continued from page 171)

prior to their introduction by means of an adapter made from a wafer socket and an old UX tube base. These tubes comprise the

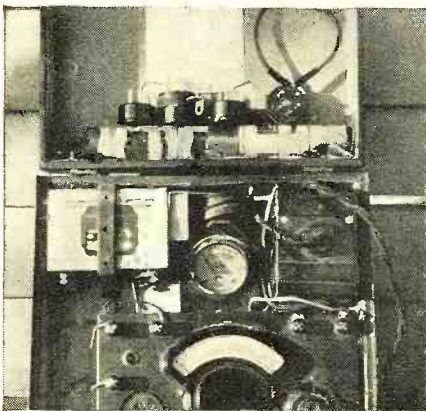

FIGURE 5

-36, -37, -38, -39, -44, -64, -65 and -67, and draw 3 ampere at 6.3 volts. The required filament potential is obtained from -10, -50

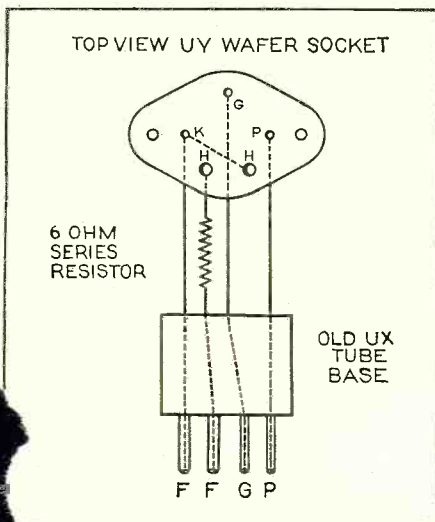

FIGURE 6

or -81 socket of the tester through the 6-ohm resistor incorporated in the adapter. The diagram of Figure 6 is self-explanatory.

An A.C.-Operated Dynatron Oscillator

Sydney R. Elliott, of Princeton, B. C., Canada, uses a dynatron oscillator for general service-bench work and recommends the circuit shown in Figure 7 for simplicity and

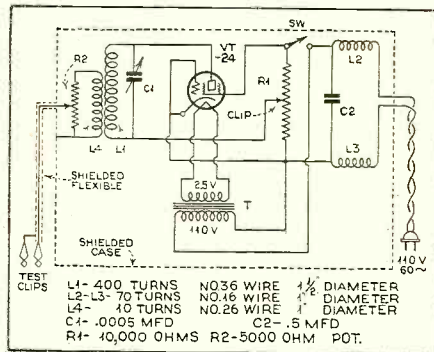

FIGURE 7

economy. All values are given on the diagram. The fundamental of the oscillator functions over a wide range of intermediate frequencies from 120 to 385 kc., and is extremely rich in harmonics, which are used for checking over the broadcast band. It can be readily calibrated against a standard broadcast receiver and the fundamental located by the fifth harmonic.

No switch is provided in the primary circuit, the heater being left on over an entire test period providing instant and accurate

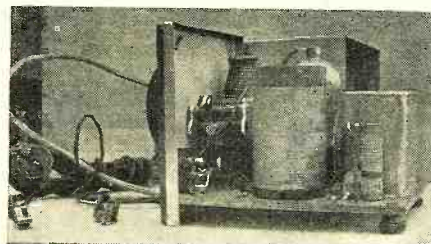

FIGURE 8

operation the moment the plate voltage switch is closed.

Figure 8 shows the completed oscillator with the outside shield removed, indicating the constructional details.

A Soldering Iron for Rural Servicing

The problems of rural servicing are often complicated by the lack of soldering facilities for minor repairs on the premises. Our old friend, the direct-heating carbon-tip "iron," comes in handy in such instances, and supplies instant and intense heat for a clean

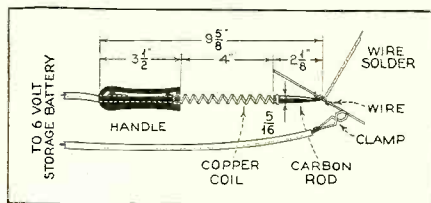
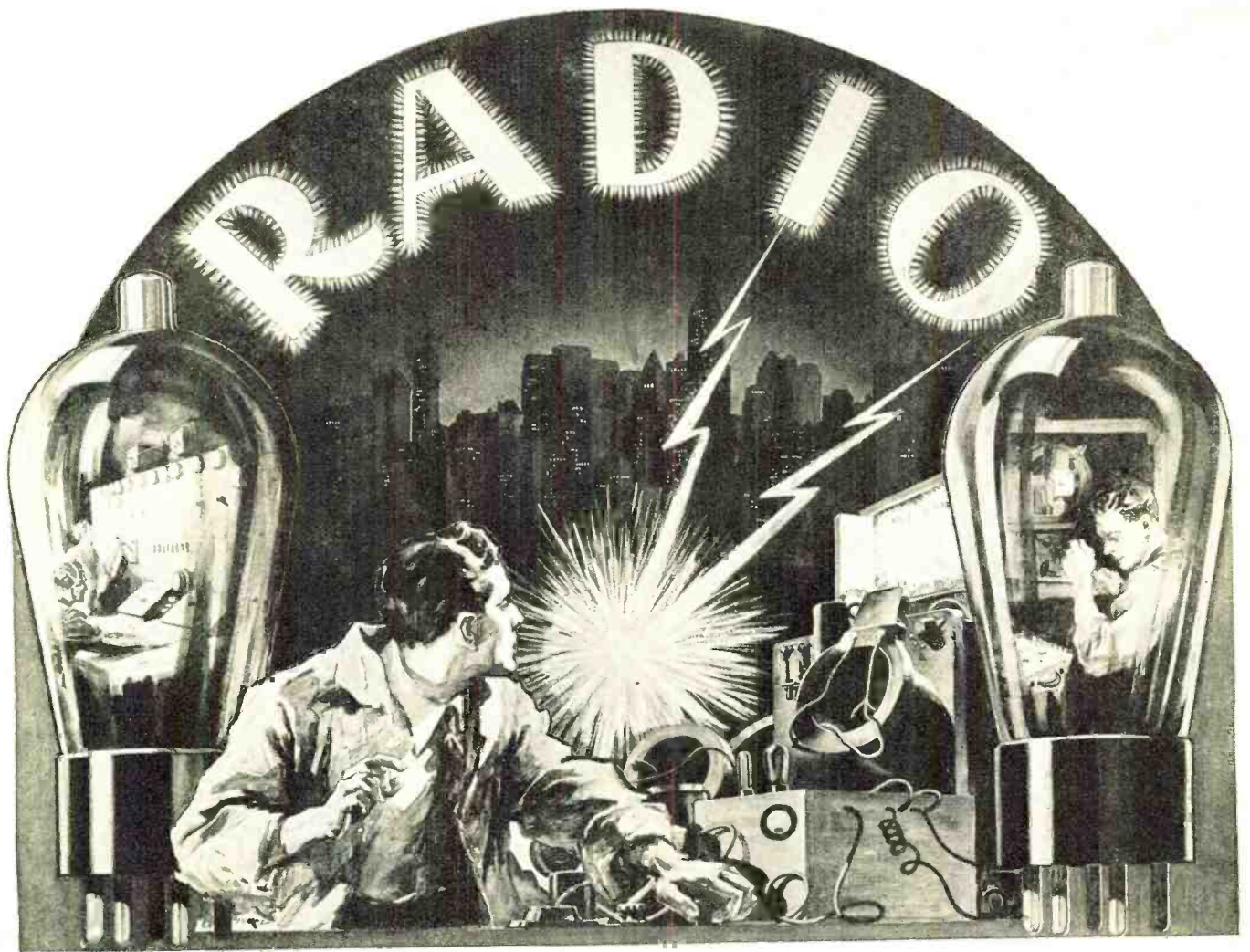

FIGURE 9

soldering job. The design of Figure 9 is contributed by Jonathan M. Askew, of Pontiac, Ill. The copper coil is of No. 10 wire and makes it possible to bend the shaft slightly in working around tight corners. The tip is the carbon rod from a radio "B" or "C" battery, filed to a point and grooved up the shank to accept the coiled wire. The groove is straightened after one or two threads, the wire meeting itself and soldered. It is advisable to tape the wire coil to prevent accidental short-circuits at points other than where the soldering is being done.



NO ONE can yet say how far-reaching will be the effect of radio on modern living and business — but every one is agreed the industry is still in its infancy . . . that its possibilities are unlimited!

This is why the wisest counselors are advising young men to acquire the fundamentals of radio . . . to prepare themselves for the opportunities ahead. The future is exceedingly bright.

Thousands are finding exactly what they need in the International Correspondence Schools' Radio Course. So can you! Prepared by experts, and

frequently revised by them, this course has the enthusiastic approval of the industry.

There is a consistent demand for radio mechanics, assemblers, testers, inspectors, draftsmen, service men, installers and salesmen; also, for operators and attendants on board ship and at commercial radio stations, government police stations and aviation stations. The field of opportunity is unlimited. Let us send you complete information — absolutely free. Just use the coupon. Mail it today—Radio beckons you.

INTERNATIONAL CORRESPONDENCE SCHOOLS

Box 8283-M, Scranton, Penna.

Without cost or obligation, please tell me about the **NEW RADIO COURSE**

Name _____ Age _____

Street Address _____

City _____ State _____

If you reside in Canada, send this coupon to the International Correspondence Schools Canadian, Ltd., Montreal, Canada.

N. EW

HETRO AC-DC COMPACT RADIOS

Featuring the latest in circuit design,
tubes and cabinet work



Super-HETRO-Dyne "ELF" Model No. 71

5-tube AC-DC superheterodyne—Automatic volume control—Full floating Dynamic Speaker—Illuminated Dial—Antenna equipped—Latest type tubes: 1-25Z5, 1-43, 1-75, 2-6D6. Receives Police Calls, 175-550 meters. Walnut Cabinet with Marquetry Inlay. Dimensions 10 1/4 x 7 x 5 1/2. Weight 8 3/4 lbs.

Other AC-DC compact models, including "Europe special" tuning from 200 to 2000 meters.

Write for our dealers' catalog describing our complete radio line. More than 30 different models. Complete receivers of chassis only, 4 to 12 tubes with single and dual speakers, for all wavelengths and types of current.

"HETRO radios are made specially for export" and must perform and last under the most trying conditions. None Better.

HETRO ELECTRICAL INDUSTRIES, Inc.

506 W. North Ave., Chicago, Ill., U. S. A.
Cable address "HETRO"

TRI-STATE COLLEGE

DEGREE IN 2 YEARS

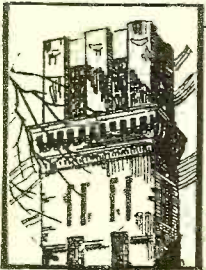

50TH YEAR

Radio Engineering

Complete Radio Engineering course in 96 weeks. Bachelor of Science Degree. Radio (television, talking pictures and the vast electronic field) offers unusual opportunities for trained radio engineers.

neers. Courses also in Civil, Electrical, Mechanical, Chemical, Aeronautical Engineering; Business Administration and Accounting. Low tuition, low living costs. World famous for technical two-year courses. Those who lack high school may make up work. Students from all parts of the world. Located in picturesque hill and lake region of northern Indiana. Enter September, January, March, June. Write for catalog.

TRI-STATE COLLEGE, 1693 College Ave., Angola, Ind.

UNIVERSAL Protected Diaphragm Type 1933 MODEL "BB"

Damage proof diaphragm protection is now added to the super-dependability of Model BB performance. The new 1933 Model BB offers a new conception of what microphone values can be. Model BB still sells at \$25.00 list.

UNIVERSAL MICROPHONE CO., Ltd.
Inglewood, Calif., U. S. A.

424 Warren Lane

SERVICEMEN ATTENTION!



TRIMM FEATHERWEIGHT EARPHONES
For Hand of Hearing Installations. Write for information.
TRIMM RADIO MANUFACTURING COMPANY
1528-38 Armitage Avenue CHICAGO, ILL.

A Handy Wire Scraper

George Mark, of Los Angeles, California, gives a long-deserved attention to the problem of insulation stripping, and sends us the drawing of Figure 10. Writes Mr. Mark:

"A simple device for stripping the insulation from wires can be made from a 9-inch length of 1/2-inch wide clock spring. The ends of the clock spring are filed to a sharp

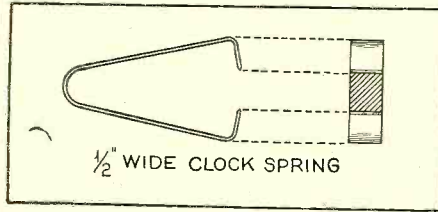

FIGURE 10

edge; and then it is bent to the shape shown in the illustration. To bare the end of an insulated wire, the wire is gripped between the sharpened edges of the clock spring, the stripper is rotated so that the insulation is cut through, and then the insulation is pulled off of the wire. The wire stripper can also be used to clean the wire after the insulation has been stripped from it. This device is far more simple to use, than a knife, for baring wire; and the time saved by its use will more than make up for the few minutes employed in making it."

THIS MONTH'S SERVICE SHOP

The service bench shown in the heading, this month, is an important adjunct to the Radio and Television Corporation, of Lynchburg, Va., and contributes several novel ideas in the way of service shop technique. As its designer, Mr. R. L. Williams, points out—

"The most unique feature of this outlay is its unit construction. The panel supports are built as a relay rack and each separate instrument is built on an individual 19-inch panel. This permits removing any unit without disturbing the others and provides for repairs or constant improvement at a minimum of inconvenience.

"At the right of the print is a turntable, with pickup built in with the P. A. amplifier, while on the bench by it is a dynatron oscillator and condenser microphone. On the left of the picture is a general-purpose radio tuner and loud speakers. The jacks are arranged so that any portion of the circuit may be used externally. On the bench are two portable tube checkers and a portable oscillator. (A Supreme analyzer failed to get in the picture.)

"The main shop equipment is in the center and measures about 3 by 6 feet. The drawers contain the most-used repair parts, while others are stored elsewhere. The instruments on the panel, beginning at the upper right-hand corner are: volt-ohmmeter (five ranges each), analyzer panel (voltage, current and point to point resistance), a.c. Wheatstone bridge, battery control panel (with rheostats, meter and current jacks), battery supply panel, large volt-ammeter, vacuum-tube voltmeter, tube test panel, decade resistance panel, second-harmonic signal generator, output v.t. voltmeter and a.c. power-supply panel.

"We are developing this equipment with the idea in mind that a radio receiver when returned to the customer, should pass the same tests as on the factory production line."

THE DAY'S WORK

"I have had several calls for poor quality reception on Philco's and several other large cabinet-type receivers. The complaint is often described as muffled tone and howling. My preliminary inspection (unless I, myself, am responsible for the original installation) is invariably for the chassis hold-down bolts. These are used to hold the chassis firmly in the cabinet during shipment, but should be removed on installation in order that the floating effect of the rubber cushions may be had. A simple point, but alas, overlooked by many servicemen who should know better."—R. H. Hines, Des Moines, Iowa.

SERVICE NOTES

Philco's recent entry into the general parts business will be of interest to all servicemen. They have expanded their parts line,

INDEX TO ADVERTISERS

Aerovox Corp.	187	National Company, Inc.	179
Alan Radio Corp.	186	National Radio & Electrical School	187
Allied Radio Corp.	185	National Radio Institute	129
Banks Inter-Air Prod.	179	National Union Radio Corp.	182
Bruno Laboratories	187	RCA Institutes, Inc.	176
Bud Speaker Co.	176	RCA Radiotron, Inc.	171
Candler System Co., The	181	RCA Victor Company, Inc.	185
Capitol Radio Engineering Inst.	179	Radio Research Laboratories	192
Central Radio Laboratories	191	Radio Technical Pub. Co.	184
Classified Advertisements	188	Radio Trading Co.	184
Coast-to-Coast Radio Corp.	181	Radio Treatise Co., Inc.	183
Electrad, Inc.	186	Radolek Co.	191
F & H Radio Laboratories	186	Readrite Meter Works	177
Fordson Radio Mfg. Corp.	192	Scott Radio Labs., Inc., E. H.	131
Hammarlund Mfg. Co.	181	Silver, Inc., McMurdo	188
Hetro Electrical Industries, Inc.	190	Silver, Marshall, Mfg. Co.	187
Hygrade-Sylvania Corp.	175	Supreme Instruments Corp.	Third Cover
International Correspondence Schools	189	Teleplex Co.	182
Kenyon Transformer Co., Inc.	173	Tilton Mfg. Co.	176
Lifetime Corp., The	185	Trimm Radio Mfg. Co.	190
Lynch Mfg. Co., Inc.	184	Tri-State College	190
Midwest Radio Corp.	Fourth Cover	Try-Mo Radio Co., Inc.	192
Miller & Miller	176	Universal Meter Works	186
		Universal Microphone Co., Ltd.	192
		Weston Electrical Instruments Corp.	169
		West Side Y.M.C.A. Radio Inst.	184
		Wholesale Radio Service	183

originally intended only for Philco replacements, to an extensive list finding wide application in the service field. Everything from replacement parts to tools, hook-up wire and polishing wax, can be obtained from this organization, and it is understood that the high quality characterizing the former exclusively Philco parts is being maintained.

The R. M. A. Color Code

While the details of the R. M. A. resistor color-code have been widely published, quite a number of service inquiries regarding this standard and simple system of resistor identification justify the following resume.

A combination of as many as three colors can be used to designate the value of a resistor. These three colors are the body color, extending from one end almost to the other cap; the end color, covering one cap; and the dot color which is a small daub on the body color. The body color represents the first significant figure; the end color the second significant figure; and the dot color the number of zeros following the first two figures. The complete code is given in the table below:

Color	Body No.	End No.	Dot No.
Black	0	0	.0
Brown	1	1	0.
Red	2	2	00.
Orange	3	3	000.
Yellow	4	4	0,000.
Green	5	5	00,000.
Blue	6	6	000,000.
Violet	7	7	0,000,000.
Gray	8	8	00,000,000.
White	9	9	000,000,000.

This table is quite easy to remember as it practically follows the usual colors of the spectrum. Two examples: 100,000 ohms, brown body, black end, yellow dot; 2,500,000 ohms, red body, green end, no dot (green dot).

SERVICE SALES PROMOTION

What can be done in the way of decking out a rural radio store is indicated in the photograph, Figure 11, showing the display window of a service and sales organization in a small, central New York town. The



FIGURE 11



TEST OUR RADIO SERVICE

SETS PARTS REPAIRS
VOICE RECORDING

ALLEN RADIO SHOP

OGUNQUIT BEACH

FIGURE 12

display material is furnished free by the radio manufacturer represented—attractive

and readily available advertising material that is passed up by many service dealers. The cardboard mannikins are life size, and, as will be observed from the illustration, are surprisingly lifelike.

The blotter is an old advertising standby, and the Allen Radio Shop, of Ogunquit Beach, Me., pepped up summer sales as shown in Figure 12. Blotters are invariably useful and are an appreciated reminder of the distributor.

Decking Out the Service Truck

The photograph of Figure 13 shows what a bit of showmanship and imagination can do with a service truck. The Ray-De-O-Ray System of Sioux City, Iowa, a strictly



FIGURE 13

service organization, emphasizes the nature of its business by constructing the body of truck in the form of a considerably overgrown "midget" receiver.

With the Experimenters

(Continued from page 155)

mounted on a wooden chassis. The A battery clips, tube and transformer are mounted on top of the chassis, also the grid leak, while the B batteries are mounted under-

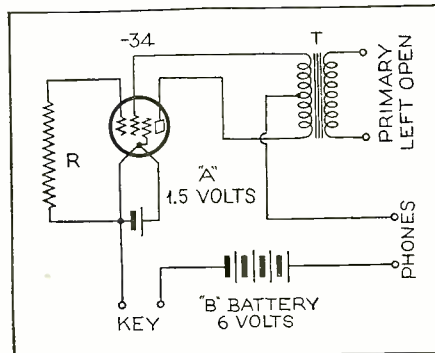

neath, held in place by clips at each end. The chassis made of thin stock similar to cigar box wood and is 4 1/2 inches long, 3 1/4 inches wide and 1 1/2 inches deep. The trans-

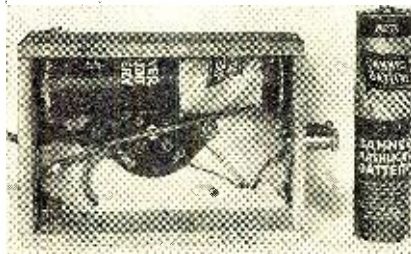

former may be almost any type having a center-tapped winding. A push-pull input transformer taken from an old Radiola X is used in this oscillator. The primary is not used and the terminals are left open.

A four-prong socket is needed for the -34 tube. The A battery is held in place by two pieces of phosphor-bronze taken from an old tube socket. Two small Fahnestock clips are provided so that an external A battery may be used when desired. The B battery

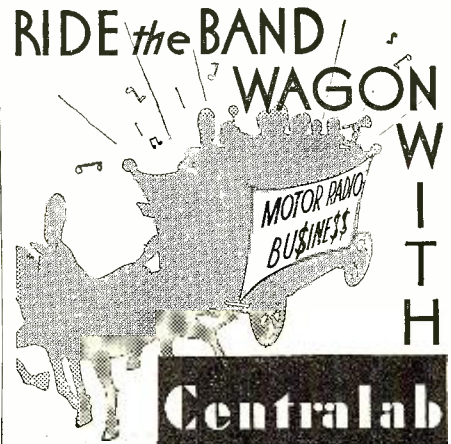

Centralab
MOTOR RADIO SUPPRESSORS



Auto radio is playing the "center ring" these days. Wise manufacturers, dealers and service men are using CENTRALAB suppressors because they do not (like some suppressors) take heavy toll of gas consumption. Use Centralab suppressors for original equipment, and for replacements.

Centralab

DEPT. B MILWAUKEE, WIS.



Best SELECTION Lowest PRICES Quickest SERVICE

Better get on our list - It Will Pay You - Send Coupon

RADOLEK CO., 209 Canal Station, Chicago

Gentlemen: Please send me the Profit Guide.

I am a Dealer Serviceman

I operate from Shop or Store from Home

I own the following Test Equipment

My training and experience is:

Name:

Address:

City: State:

RADOLEK

Announcing— the RRL-7B-X Custombuilt Radio

2 the Price!

SHORT WAVE SUPER

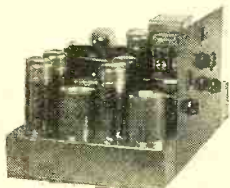

BAND SPREAD WITHOUT PLUG-IN COILS

Before buying any receiver you will want to get complete particulars on the RRL-7B-X Custom-built S. W. receiver developed by R. H. Liedtke and Associates, consulting engineers and designers to the Radio Electrical Industry for over 20 years. The RRL-7B-X Custom-built Super was designed for the serious student of short waves who will never be satisfied with anything less than the ultimate in reception. The fan who has become weary of promises, controversial data, and extravagant advertising claims will find in the RRL-7B-X the answer to his prayers—real outstanding performance—at about *one-half the Price!* An independent survey made by our organization among amateurs and short-wave fans convinces us there is a definite need for a very fine short wave receiver at a price to suit the times. Send for details. Please use the coupon.

RADIO RESEARCH LABORATORIES

Manufacturers, Designers, Consulting and Experimental Engineers

2017 California Ave., Ft. Wayne, Ind.

20 Years in the Radio Electrical and Mechanical Field

RADIO RESEARCH LABORATORIES
2017 California Ave., Ft. Wayne, Ind.

Send me complete information on the RRL-7B-X Custom-built S. W. Receiver. (We supply all postage.)

Name.....
Street.....
Town..... State.....

FORDSON presents RADIO'S BIG VALUE

Here is the most remarkable catalog we have ever issued. Packed full of the biggest values we ever offered. Deal direct—save money on guaranteed quality radios and accessories. Famous line of Goldentone household radios.

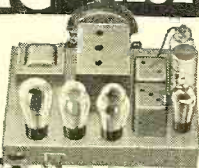

NEW FORDSON CAR RADIO!

New Fordson auto radios, installations, etc. completely illustrated. New low dealer prices on these performance-improved sets will open your eyes! Get your advance copy of this latest and best catalog before prices rise—its FREE. Send coupon today.

30 DAYS
FREE
TRIAL

\$9.95

6-tube chassis & dynamic speaker

Our greatest value in household radio... new 6-tube Goldentone superheterodyne... gets police calls—automatic volume control—full range tone control—dynamic speaker—new duplex 55 and Class A type 2A5 tubes. M. A. Adkins, W. Va., says "Outperformed 12 tube set in every way." Complete with beautiful budget cabinet, 6 Raytheon tubes, \$13.85.



Buy direct, save!
BIG, NEW
CATALOG

FREE

Fordson Radio Mfg. Corp.
11701 Livernois, Detroit, Mich.

Send me the big, new FREE catalog right away.

Name.....
Address.....

New 108 PAGE free
1933 RADIO
CATALOG
Replete with BARGAINS GALORE for
DEALERS—SERVICEMEN—AMATEURS
Send for Your Copy TODAY!
TRY-MO RADIO CO. 85 CANTLAND ST.
Dept. R-9 NEW YORK CITY

clips are made from the same materials as the A battery clips.

The value of the grid leak is not critical. It may vary from 1/2 to several megohms. The higher the resistance of the leak, the higher the tone of the oscillator. In this oscillator the grid leak may be left out and the control grid left entirely unconnected. Try this; it raises the tone of the oscillator.

IVER HANSEN,
Nunn, Colo.

High Resistance Photo-Cells

Selenium cells that have a high resistance cannot be used with the ordinary amplifier and relay, because the resistance of the cell is sometimes too high to permit its use in conventional circuits.

I tried numerous methods to make an amplifier and relay that would operate satisfactorily with these cells. I finally hit on the idea to use a Wheatstone bridge as an amplifier and relay. The accompanying circuit illustrates this. The cell is connected in the Wheatstone Bridge circuit where the unknown resistance should be connected. Instead of using a galvanometer, an instrument type relay is connected in the circuit, where

the galvanometer would ordinarily be connected. When the bridge is adjusted to the resistance of the cell, no current will flow through the relay, but as soon as the cell changes its resistance due to its picking up a

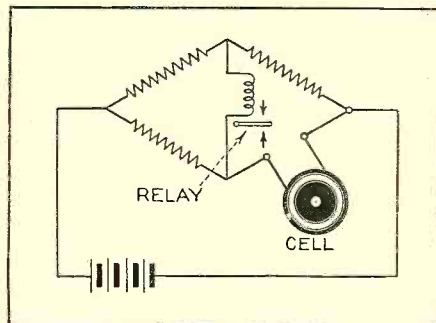

beam of light, the bridge will become unbalanced and current will flow, operating the relay.

This type of amplifier and relay will work on other types of photoelectric cells also.

WM. NAKEN,
Chicago, Ill.

Radio News Technical Information Service

The Technical Information Service has been carried on for many years by the technical staff of RADIO NEWS. Its primary purpose is to give helpful information to those readers who run across technical problems in their work or hobby which they are not able to solve without assistance. The service has grown to such large proportions that it is now advisable to outline and regulate activities so that information desired may come to our readers accurately, adequately and promptly.

Long, rambling letters containing requests that are vague or on a subject that is unanswerable take up so large a portion of the staff's working time that legitimate questions may pile up in such quantities as to cause a delay that seriously hinders the promptness of reply. To eliminate this waste of time and the period of waiting, that sometimes occurs to our readers as a consequence, the following list of simple rules *must* be observed in making requests for information. Readers will help themselves by abiding by these rules.

Preparation of Requests

1. Limit each request for information to a single subject.
2. In a request for information, include any data that will aid us in assisting in answering. If the request relates to apparatus described in RADIO NEWS, state the issue, page number, title of article and the name of the device or apparatus.
3. Write only on one side of your paper.
4. Pin the coupon to your request.

The service is directed specifically at the problems of the radio serviceman, engineer, mechanic, experimenter, set builder, student and amateur, but is open to all classes of readers as well.

All questions from subscribers to RADIO NEWS will be answered free of charge, provided they comply with the regulations here set forth. All questions will be answered by mail and not through the editorial columns of the magazine, or by telephone. When possible, requests for information will be answered by referring to articles in past issues of

the magazine that contain the desired information. For this reason it is advisable to keep RADIO NEWS as a radio reference.

Complete information about sets described in other publications cannot be given, although readers will be referred to other sources of information whenever possible. The staff cannot undertake to design special circuits, receivers, equipment or installations. The staff cannot service receivers or test any radio apparatus. Wiring diagrams of commercial receivers cannot be supplied, but where we have published them in RADIO NEWS, a reference will be given to past issues. Comparisons between various kinds of receivers or manufactured apparatus cannot be made.

Only those requests will be given consideration that are accompanied by the current month's coupon below, accurately filled out.

SEPTEMBER, 1933

Technical Information Coupon
RADIO NEWS Laboratory
222 W. 39th Street
New York, N. Y.

Gentlemen:

Kindly supply me with complete information on the attached question:

- I am a regular subscriber to RADIO NEWS, and I understand this information will be sent me free of charge.
- I am not yet a subscriber to RADIO NEWS.
- I wish to become a subscriber to RADIO NEWS, and enclose \$2.50 to receive the magazine regularly for one year, and to receive this valuable technical information service free of charge.

Name.....

Address.....

again

SUPREME LEADS

• WITH FREE REFERENCE POINT SYSTEM OF ANALYSIS •

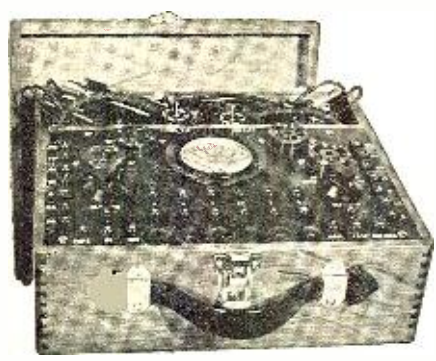

A NEW and modern ANALYZER MODEL 333

The new Model 333 is a modern Analyzer combined with a point-to-point tester, employing an exclusive circuit for compensating the effects of temperature and other variations of the full-wave rectifier unit and for utilizing a rugged D'Arsonval meter for A. C. and D. C. measurements on a single uniform scale without the confusion of offset scales or of scales with crowded divisions at the lower end, and enables (1) complete point-to-point resistance, voltage, and current analyses; (2) tube testing from the radio socket with self-contained grid shift battery; (3) capacitor leakage tests, including electrolytic capacitors; (4) use of head-phones, loud speakers, microphones, etc., connections for all miscellaneous tests, and (5) six range output meter available for convenient use without the necessity of troublesome output adapters.

In using the Model 333 it is unnecessary to remove the chassis of the radio or to dismantle it in order to gain access to the circuits for "point-to-point" tests with test probes as is necessary with the usual "point-to-point" set tester. Provides A. C., D. C., M. A., output ranges of 0/5/25/125/250/500/1250 mils or volts, Resistance ranges of 0/1,000/10,000/100,000/1,000,000 ohms; and capacity ranges of 0/125/1.25/12.5 mfd. All readings direct on meter—no charts. Uses Supreme's exclusive FREE REFERENCE POINT SYSTEM of analysis.

The Model 333 Supreme Analyzer invites comparison with ANY instrument at ANY price. Calibrated for 60 cycle.

Dealers' Net Cash Wholesale Price **\$39.50**

Supreme's New Models Are Carried by Most Leading Jobbers

The NEW MODEL 444

Five Unit Radio Tester

Here is the new Model 444 Five Unit Radio Tester—designed to meet the demand for complete laboratory equipment at modest cost. Incorporates the functions of a modern analyzer, an A. C. tube tester, a shielded oscillator, an ohm-megohmmeter, and a capacitor tester. The Analyzer offers FREE REFERENCE POINT SYSTEM OF ANALYSIS, tube tester accommodates ALL tubes including latest types without adapters, oscillator is completely shielded and insures utmost accuracy from 130 to 1875 kilocycles and the 20, 40, and 80 meter short wave bands. Complete laboratory equipment engineered into a single instrument as only Supreme knows how.

Dealer's Net Cash Wholesale Price **\$89.50**

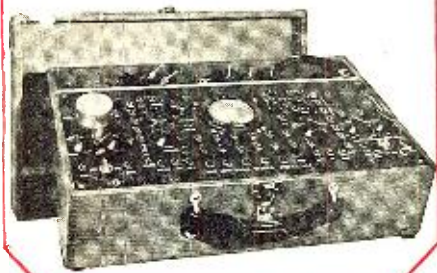

greatest testing instruments in radio history

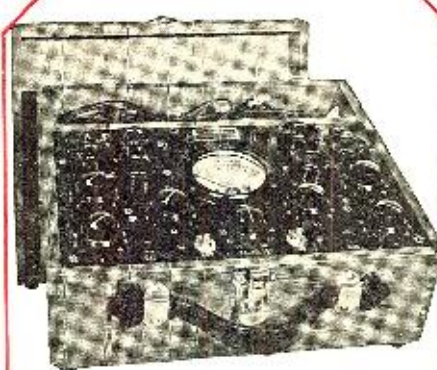

New Model 45 Tube Tester

Tests All Tubes Without Adapters

Your tube tester is obsolete if it does not offer FREE REFERENCE POINT SYSTEM OF TUBE TESTING. This new Model 45 Tube Tester tests all new tubes without adapters at the proper electrode voltage and is the first designed to take new tube developments as they come out. All filaments from 1.5 to 30 volts including top heater types. Tests for gas. Six ten point tap switches allow application of proper potentials to all tube electrodes regardless of arrangement of pin connection. Will test A, B, C, D, Y, Z series including duo-diode connections. A real tube tester for the real radio-man.

Dealer's Net Cash Wholesale Price **\$29.50**

SUPREME INSTRUMENTS CORP. 469 Supreme Bldg., Greenwood, Miss.

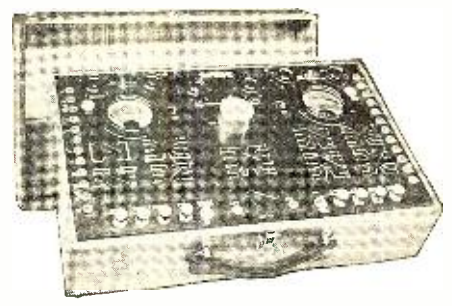

A NEW and even greater DIAGNOMETER The MASTER Series

For those who desire the ultimate in complete laboratory test equipment. Tests ALL tubes including NEWEST TYPES without adapters—on a meter dial which is colored for accurate "Bad," "Doubtful," and "Good" transconductance classifications; and is adjustable to varying power supply potentials. Tubes can also be tested from the sockets of operative radios.

The famous patented Supreme MULTIMETER circuit is calibrated with a full-wave crystalline rectifier unit for accurate measurements of:

- M. A. ranges 0/2.5/10/25/100/250
 - M. A. and 0/2.5 amperes.
 - A. C.—D. C. Output ranges 0/2.5/10/25/100/250/1,000/2,500 volts.
 - Capacity ranges 0/0.01/1.0/10 mfd.
 - Ohm ranges 0/500/5,000/50,000/500,000 ohms.
 - Megohm ranges 0/5/25 megs.
- All readings made directly on meter dials—no charts.

The exclusive Supreme FREE REFERENCE POINT system of analysis is still further improved in the Master Diagnometer, so that all point-to-point analytical measurements are made by the use of plainly marked switches. This advance in test instrument design not only provides maximum speed and flexibility but guards against early obsolescence.

An A. C.—D. C. specially-stabilized and completely-shielded 100% modulated oscillator circuit with variable attenuator is employed with tap switch tuning frequencies marked on the panel so that tuning charts are not required; maximum tuning accuracy is assured at 11 fundamental frequency settings ranging from 130 to 1875 kilocycles, and covering the 20, 40, and 80 meter short-wave bands. The most beautiful and complete instrument in the world.

Dealer's Net Cash Wholesale Price **\$147.50**

New Catalog Now Ready Write For It Today

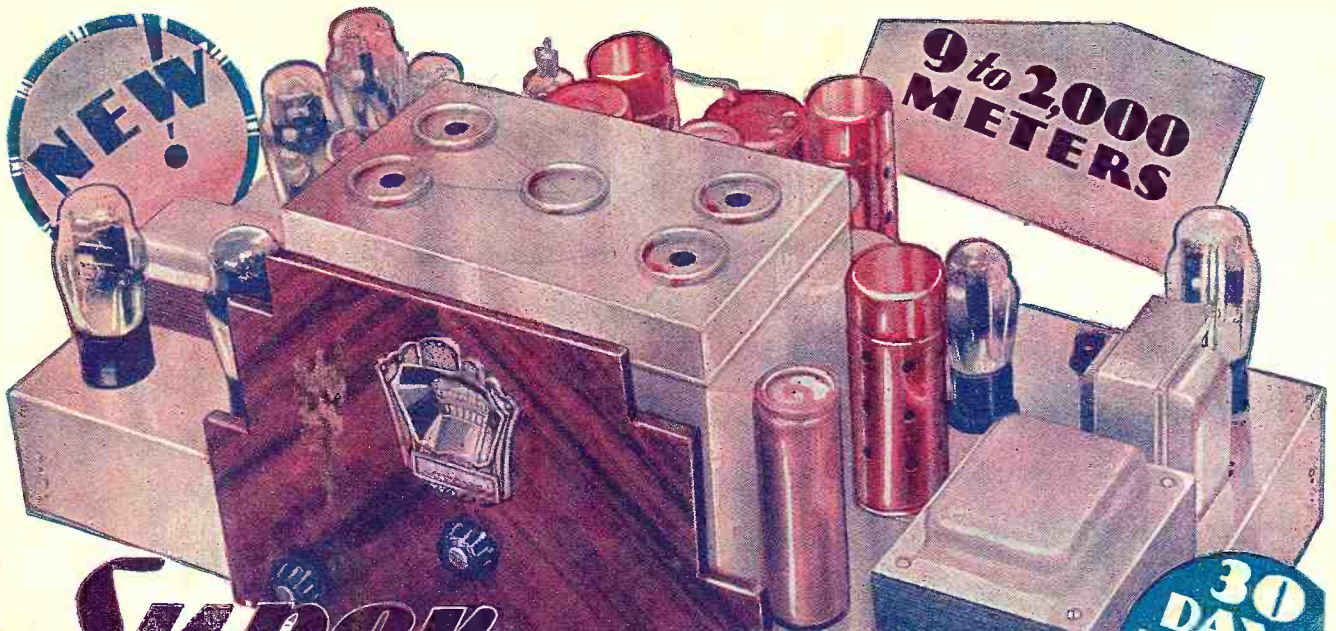

Super Deluxe 16-TUBE ALL-WAVE RADIO

WORLD'S GREATEST
RADIO VALUE

30
DAYS
FREE
TRIAL

\$47.50
with New
Deluxe
Auditorium Type
SPEAKER

WORLD-WIDE RECEPTION!

BUY your radio direct from the Midwest Laboratories and save from 30% to 50%. This Super, De luxe 16-Tube ALL-WAVE Radio enables you to secure clear, loud-speaker reception from stations 10,000 miles and more distant. It gives you complete wave length coverage of 9 to 2,000 meters (33 megacycles to 150 KC)—enabling you to secure almost magical radio performance! Midwest users regularly log such stations as: GSC, London—VK2ME, Sydney, Australia—JIAA, Tokio, Japan—RW50, Moscow, Russia, etc. Never before so much radio for so little money! Send coupon today!

Why be satisfied with an ordinary broadcast or "dual" wave set when you can have a super-powerful de luxe 16-tube ALL-WAVE Midwest radio? It puts the whole world of radio at your finger tips. It has FIVE distinct wave bands—ultra short, short, medium, broadcast and long—all tuned with a single dial! You can switch instantly from U. S. programs . . . Canadian, police, amateur, commercial, airplane and ship broadcasts—to the world's finest short wave programs from Australia, Japan, Russia, Italy, Germany, France, England, South America, etc.



Remarkable Distance
"Listening now to EAQ, Madrid. 12RO, Rome, is sending us opera every afternoon. VK2ME, Sydney, Australia, came in strong. Other short wave cities heard include Paris, Mexico, Moscow, Buenos Aires, Hilversum (Holland), as well as U. S. and Canadian stations. Police calls come in from coast to coast. I have been amazed at the remarkable distance . . . selectivity."

RICHARD R. MUNGER,
Janesville, Wisc.

**Terms
AS LOW AS
\$500
DOWN**

40 NEW 1934 FEATURES

These sensational new features give you amazing performance, perfect realism, new beauty of tone, new wealth of power, fractional microvolt sensitivity, better than 7 KC selectivity. For example—Automatic SELECT-O-BAND (exclusive with Midwest) simplifies short wave tuning by instantly pointing out wave length of station. Some of the other features include: Amplified Automatic Volume Control; New-Type Tubes, 16-Tubes, Balanced Unit Superheterodyne Circuit; Velvety Action Tuning, Super Power Class "A" Amplifier, 30 Tuned Circuits, New Duplex-Diode-High Mu Pentode Tube, No-Image Heterodynes, Full Rubber Floated Chassis, Variable Tone Blender, Centralized Tuning, 5 Wave Bands, 7 KC Selectivity, new Thermionic Rectifier, etc.

**DEAL DIRECT WITH LABORATORY
—SAVE UP TO 50%**

Get a bigger, better, more powerful, clearer-toned radio—at a positive saving of from 30% to 50%. Buy now while you can take advantage of the tremendous values Midwest offers you. No middlemen's profits to pay. Present inflationary legislation is sure to result in higher prices. Try any Midwest radio 30 days before you decide. As little as \$5.00 puts a set in your home. Just sign and mail coupon—or send name and address on postcard.



New Style Consoles
The new, big Midwest catalog shows a complete line of beautiful, artistic, de luxe consoles . . . in the new, modernistic designs . . . and priced to save you 30% to 50%. Hand made by Master Craftsmen, they lend distinction and dignity to any home. Mail the coupon today.

**RUSH THIS COUPON FOR
AMAZING 30-DAY FREE TRIAL
OFFER AND NEW 1934 CATALOG**

MIDWEST RADIO CORP.,
Dept. 236
Cincinnati, Ohio.

Without obligation on my part send me your new 1934 catalog, and complete details of your liberal 30-day FREE trial offer. This is NOT an order.

**AGENTS!
Make Easy
Extra Money.**
Check Here for Details

Name _____
Address _____
City _____
State _____

MIDWEST RADIO CORP.

DEPT. 236 — CINCINNATI, OHIO, U. S. A.

Established 1920

Cable Address Miraco. ABC 5th Edition